



Style. Performance. Innovation.





MULTIGLIDE™
DOORS

Redefine Boundaries.

Remove the boundary between indoors and out and create truly spectacular spaces with Big Doors from the Andersen® Architectural Collection.

The MultiGlide™ door, as part of our Architectural Collection, not only connects a home to the outdoors, it can be customized to fit any aesthetic from contemporary to traditional. With an array of styles and configurations available, this door will transform any space into something extraordinary.

Beyond offering ultimate design freedom, the MultiGlide door is engineered for smooth and easy operation, offers seamless transitions and provides the performance and innovation you expect from Andersen.

Create distinction and bring your vision to life with the MultiGlide door from the Andersen Architectural Collection.

For more information, visit andersenwindows.com/multiglide.



Andersen® Architectural Collection MultiGlide™ door.

MULTIGLIDE™ DOORS

FEATURES

Doors are available in stacking and pocketing configurations, in one-directional and two-directional options and fit openings up to 25' (7620) wide and 10' (3048) tall.* Configurations shown on pages 8-11.

Frame

A The frame is made of 6063-T6 extruded aluminum. Pultruded thermally controlled frame option for increased performance is available for clad wood panels only.

B Continuous weatherstrip is designed to provide an effective air and water barrier, while enabling smooth operation.

C Frames paired with aluminum panels are available in eight popular options, including two anodized finishes. For doors with clad wood panels, interior jambs are available in wood species and finishes to match the panels. Standard exterior finish meets AAMA 2604. An optional finish that meets AAMA 2605 is available.

Built-in Jacking Screws



Built-in jacking screws make installation easier. Jacking screws positioned within side and head jambs serve as built-in shims enabling fine adjustments during installation. Precision adjustments enable frame and panels to interact as designed during initial installation and throughout the life of the product for smooth operation.

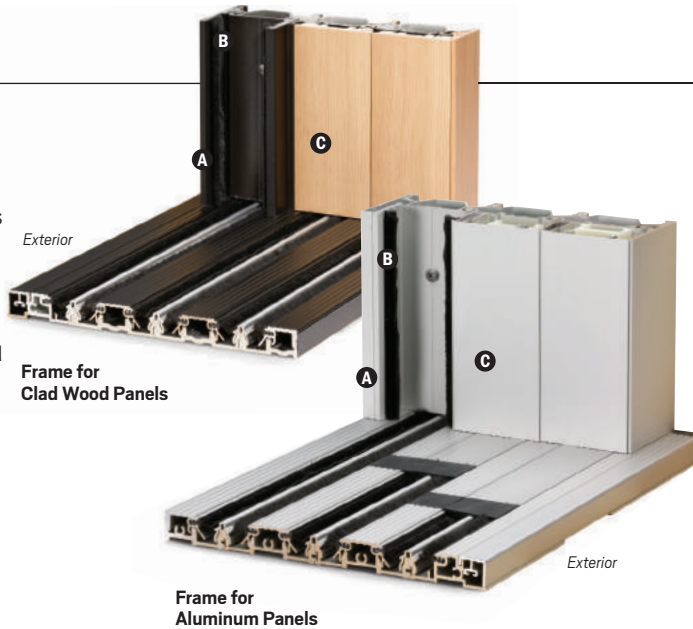

Frame for Clad Wood Panels

Frame for Aluminum Panels



Contemporary Panel
2 3/4" Bottom Rail

Traditional Panel
8" Bottom Rail
(4 1/16" or 12" Bottom Rail also available)

Panels

For added design flexibility, contemporary panels are available in a sleek, aluminum option or an aluminum-clad wood option for warmth on the inside. Traditional panels are available in aluminum-clad wood. Thermally controlled units use aluminum-clad wood panels. Panel widths can be 28" (711) to 60" (1524) wide.

Contemporary aluminum panels feature 2 3/4" (70) stiles and rails. Contemporary clad wood panels feature 2 3/4" (70) lock jamb stiles and rails with reinforcements at interlocks. Traditional clad wood panels feature 4 1/16" (119) stiles with 4 1/16" (119), 8" (203) or 12" (305) bottom rail heights.

Sill

Two sill types are available: flush sill and on-floor drainage sill. Both sills are made of heavy-duty extruded 6005-T5 aluminum providing strength and rigidity.

Flush Sill



Material between rails shown to represent flooring.

Flush sill is designed to project only 3/16" (5) above the finished floor, creating a seamless transition from inside to outside. Finish is clear anodized. Flush sill is not tested for water performance.

On-Floor Drainage Sill

The on-floor drainage sill is designed with built-in drainage channels, spaced out every 17" (432) to 24" (610) depending on overall width. Available in clear or dark bronze anodized finishes.



Exterior Ramp



Interior Ramp

Exterior and interior ramps for on-floor drainage sill are designed to assist in complying with sliding door threshold height requirements where mandated by the federal Fair Housing Act (FHA), American with Disabilities Act (ADA) and state and local building codes depending on final installation.** See page 12 for threshold and ramp options. Interior ramp cannot be used with optional raised threshold.



Raised Threshold

An optional raised threshold for on-floor drainage sill enhances performance to PG30 rating on select sizes.†

*Opening dimensions are rough opening. **Information about mandatory requirements for door threshold heights and other applicable accessibility requirements for doors under the FHA and ADA can be found by visiting <http://www.fairhousingfirst.org> and <http://www.ada.gov>. †191" x 95.5" MultiGlide door tested to Class LC-PG30. Specifiers and design professionals should also consult state and local building codes applicable to the building for any additional accessibility requirements.

Glass

Panels are silicone bed glazed and finished with an interior stop. Ovolo (colonial) or contemporary glass stops are available on clad wood panels. Contemporary glass stops are used on aluminum panels.

Glass spacer bars are available in stainless steel or optional black.

High-Performance glass options include:

Dual-pane:

- Low-E4® tempered glass
- Low-E4 HeatLock® tempered glass
- Low-E4 Sun tempered glass
- Low-E4 SmartSun™ tempered glass
- Low-E4 SmartSun HeatLock tempered glass
- Low-E4 PassiveSun® tempered glass

Triple-pane for greater energy performance:

- Low-E4 tempered glass
- Low-E4 Enhanced tempered glass
- Low-E4 SmartSun tempered glass
- Low-E4 SmartSun Enhanced tempered glass

Additional glass options are available. Contact your Andersen supplier.

A removable translucent film helps shield the glass from damage during delivery and construction and simplifies finishing at the jobsite.

Packaging

Modular packaging design enables easier handling without the need for on-site equipment. Heaviest package designed for a minimum of four people. Smallest package weighs less than 100 lbs or 45 kg.

Smart labeling provides quick inventory assessment, product identification, along with installation location designation.



Hardware*

Locking System

Sleek, low-profile hardware design allows panels to be stacked. Keyed and non-keyed options are available.



The MultiGlide door has an adjustable two-point locking system providing intuitive adjustment. Equipped with laminated stainless steel hooks and an anti-slam device to prevent damage to the side jamb.

Roller Wheels



Continuously adjustable synthetic roller wheels with stainless steel ball-bearings provide smooth, quiet operation. Cycle tested 25,000 times for proven operation, the 1 5/8" (41) contoured rollers perfectly match the track to reduce lateral vibrations and increase ease of operation.

ACCESSORIES*

Hardware

Exterior Keyed Lock



A five-pin exterior keyed lock is available for all MultiGlide™ doors. This lock allows the door to be locked and unlocked from the exterior.

Edge Pull



Premium spring return edge pull is optional on stacking configurations and standard on pocketing configurations to move lead panel out of the pocket. Finish is satin nickel.

Insect Screen

Rigid heavy-duty extruded 6063-T6 aluminum framed bottom gliding insect screen, equipped with smooth synthetic rollers and premium flush hardware. Features 2 3/4" (70) even sight lines to maximize view. Long-lasting fiberglass screen mesh with a charcoal finish comes standard. Insect screen frames are available in all exterior colors and finishes and in single-panel and multi-panel configurations.

Grilles

For contemporary aluminum panels, Finelight™ grilles-between-the-glass are available in 5/8" (16) flat or 1" (25) contoured profiles.

For contemporary clad wood and traditional clad wood panels, grilles are available in ovolo and contemporary profiles in Full Divided Light and Simulated Divided Light styles in 7/8" (22), 1 1/8" (29) and 1 1/2" (38) widths. Removable wood grilles and Finelight grilles-between-the-glass are also available.

HARDWARE*

Keyed and non-keyed options are available.



NEW OPTIONAL AUTOMATED OPEN/CLOSE SYSTEM*

When it comes to innovation, the MultiGlide door delivers the ultimate in ease-of-use with its new automation option. With the touch of a button, our MultiGlide door can now be opened or closed, creating wide open spaces in the most convenient way.



- Automation is available on all stacking and pocketing door configurations**
- Operate using an interior touchpad and weatherproof exterior secure keypad
- Includes safety features such as overhead motion sensors and obstruction detection
- Battery backup included to keep the system secure
- Installed by third-party certified installers at the jobsite
- Backed by a five year limited warranty

*Sold separately.
**Automation is not available for doors with panels that are less than 34" in width and insect screens are not automated with this feature. Dimensions in parentheses are in millimeters.

MULTIGLIDE™ DOORS

ALUMINUM-CLAD WOOD DOOR EXTERIOR

STANDARD COLORS



INTERIOR

WOOD SPECIES

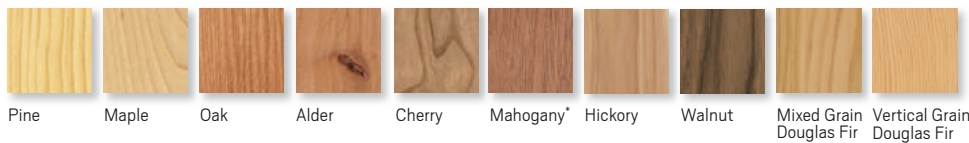

Naturally occurring variations in grain, color and texture of wood make each door one-of-a-kind. All wood interiors are unfinished unless a painted option is specified.

FACTORY-FINISHED INTERIORS



PAINTED OPTIONS Available on pine.



ANODIZED FINISH OPTIONS

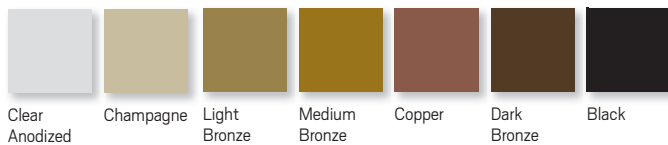

ALUMINUM DOOR EXTERIOR & INTERIOR



*Actual wood is Sapele, a non-endangered species of mahogany grown in Africa, with color and characteristics similar to American mahoganies.
 **Dark Bronze and Black also available on maple. †Anodized Silver available on maple only.
 Printing limitations prevent exact duplication of colors and finishes.
 See your Andersen supplier for actual color and finish samples.



MULTIGLIDE™ DOORS

CUSTOM SIZING
in 1/8" (3) increments



SECTION REFERENCE

Styles & Sizes	8-11
Door Details	12-19
Product Performance.....	20-21
Warranty.....	22-23

Dimensions in parentheses are in millimeters.

MULTIGLIDE™ DOORS

MultiGlide™ Door Styles and Sizes

CUSTOM HEIGHTS (rough opening dimensions provided)

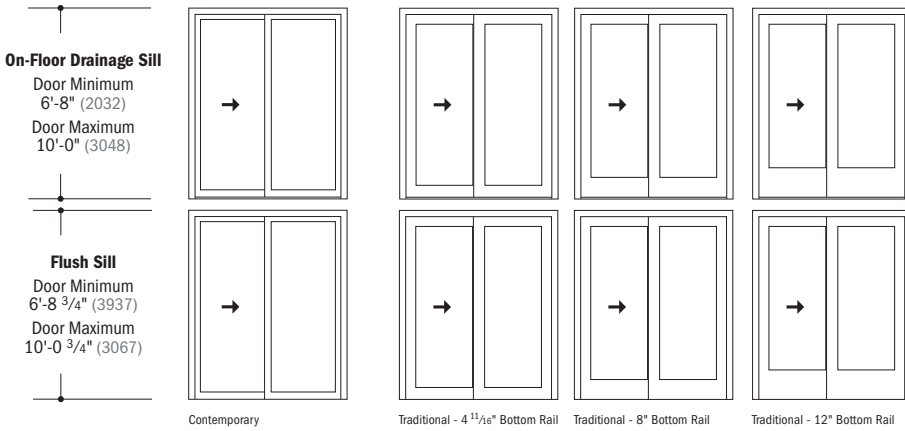

Custom sized in 1/8" (3) increments. Contact your Andersen supplier for additional dimensions and specifications.

Choose contemporary panels or one of three traditional style panels. Panel widths from 28" (711) to 60" (1524). For doors with on-floor drainage sill, panel heights are from 76 1/2" (1943) to 116 1/2" (2959). For doors with flush sill, panel heights are from 76" (1930) to 117" (2972).

Note: For on-floor drainage sill, rough opening dimensions are from floor to header. For flush sill, dimensions are from 1 1/2" (38) below the finished floor to header. Shim space between the head jamb and rough opening is 1/2" (13). For flush sill, shim space below the sill is 1/4" (6).

TWO-DIRECTIONAL INTERIOR STACKING

Configurations

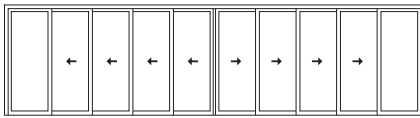

Two-Directional Interior Stacking

Two-directional interior stacking as viewed from the exterior. Number of panels and width dimensions vary based on panel style and configuration. Flush sill and contemporary panels shown above, on-floor drainage sill and/or traditional panels also available. Details shown on pages 12-14.

JAMB DEPTHS*

Number of Panels & Handing	No Insect Screen	Single-Panel Insect Screen	Multi-Panel Insect Screen
4-Panel, S1L-1RS	5 3/8" (137)	n/a	7 7/8" (200)
6-Panel, S2L-2RS	7 7/8" (200)	n/a	1'-0 7/8" (327)
8-Panel, S3L-3RS	10 3/8" (264)	n/a	1'-5 7/8" (454)
10-Panel, S4L-4RS	1'-0 7/8" (327)	n/a	1'-10 7/8" (581)

*On-floor drainage sill extends 3/4" (19) to the exterior, optional exterior ramp extends 2 1/4" (52) to the exterior and optional interior sill ramp extends 1 3/8" (35) to the interior.

CUSTOM WIDTHS (rough opening dimensions provided)

CONTEMPORARY PANELS	
Number of Panels & Handing	Rough Opening Minimum to Maximum
4-Panel, S1L-1RS	9'-5 5/8" (2886) to 20'-0 3/8" (6106)
6-Panel, S2L-2RS	13'-9 1/4" (4197) to 25'-0" (7620)
8-Panel, S3L-3RS	18'-0 7/8" (5509) to 25'-0" (7620)
10-Panel, S4L-4RS	22'-4 1/2" (6820) to 25'-0" (7620)

TRADITIONAL PANELS	
Number of Panels & Handing	Rough Opening Minimum to Maximum
4-Panel, S1L-1RS	9'-1 3/8" (2778) to 19'-9 1/4" (6026)
6-Panel, S2L-2RS	13'-0 5/8" (3978) to 25'-0" (7620)
8-Panel, S3L-3RS	17'-0" (5182) to 25'-0" (7620)
10-Panel, S4L-4RS	20'-11 1/4" (6382) to 25'-0" (7620)

- Shim space between unit dimension and rough opening is 1/2" (13) on each side.
- For detailed sizing information, visit andersenwindows.com/multiglide or contact your Andersen supplier.

TWO-DIRECTIONAL INTERIOR STACKING

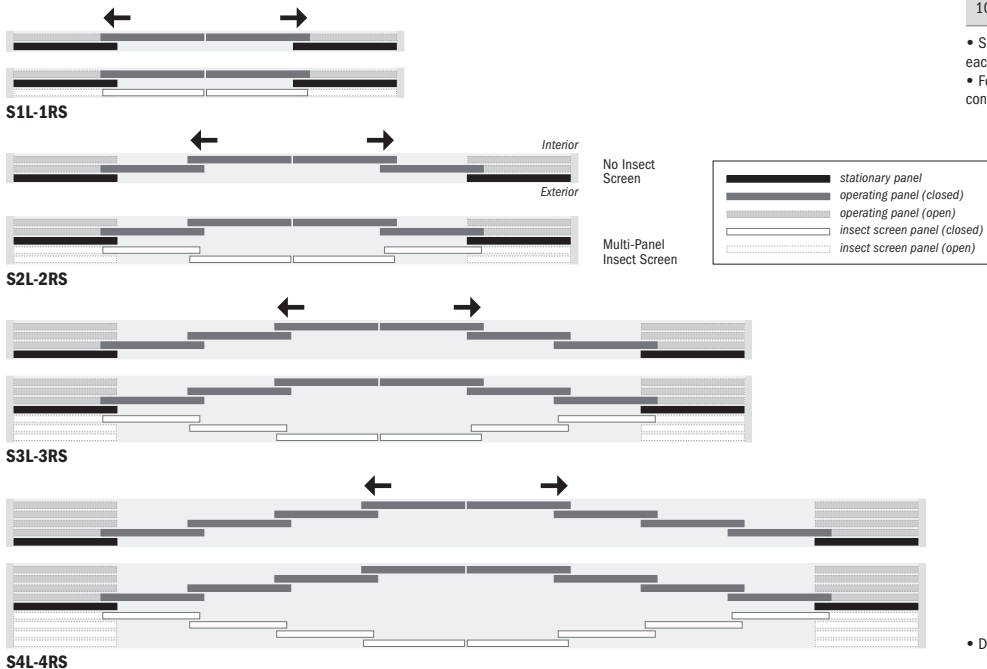

• Dimensions in parentheses are in millimeters.

ONE-DIRECTIONAL INTERIOR/EXTERIOR STACKING (L/R)

Configurations

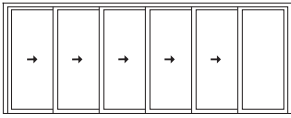

One-Directional Interior Stacking (R)

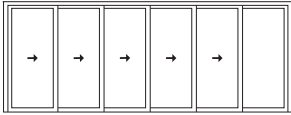

One-Directional Exterior Stacking (R)

Choose one-directional (left or right) interior or exterior† stacking as viewed from the exterior. Number of panels and width dimensions vary based on panel style and configuration. Flush sill and contemporary panels shown above, on-floor drainage sill and/or traditional panels also available. Details shown on pages 12-16.

JAMB DEPTHS*

Number of Panels & Handing	No Insect Screen	Single-Panel Insect Screen**	Multi-Panel Insect Screen**
2-Panel, S1L/S1R	5 3/8" (137)	7 7/8" (200)	7 7/8" (200)
3-Panel, S2L/S2R	7 7/8" (200)	10 3/8" (264)	1'-0 7/8" (327)
4-Panel, S3L/S3R	10 3/8" (264)	1'-0 7/8" (327)	1'-5 7/8" (454)
5-Panel, S4L/S4R	1'-0 7/8" (327)	1'-3 3/8" (391)	1'-10 7/8" (581)
6-Panel, S5L/S5R	1'-3 3/8" (391)	1'-5 7/8" (454)	2'-3 7/8" (708)

*On-floor drainage sill extends 3/4" (19) to the exterior, optional exterior ramp extends 2 1/16" (52) to the exterior and optional interior sill ramp extends 1 3/8" (35) to the interior.
**Single-panel insect screen is not available for interior stacking doors. Multi-panel insect screen is not available for external stacking doors.

CUSTOM WIDTHS (rough opening dimensions provided)

CONTEMPORARY PANELS	
Number of Panels & Handing	Rough Opening Minimum to Maximum
2-Panel, S1L/S1R	4'-11 1/8" (1502) to 10'-2 1/2" (3112)
3-Panel, S2L/S2R	7'-0 7/8" (2156) to 14'-11 3/4" (4566)
4-Panel, S3L/S3R	9'-2 3/4" (2813) to 19'-9" (6020)
5-Panel, S4L/S4R	11'-4 1/2" (3467) to 24'-6 1/4" (7474)
6-Panel, S5L/S5R	13'-6 3/8" (4124) to 25'-0" (7620)

TRADITIONAL PANELS	
Number of Panels & Handing	Rough Opening Minimum to Maximum
2-Panel, S1L/S1R	4'-9" (1448) to 10'-0 7/8" (3070)
3-Panel, S2L/S2R	6'-8 5/8" (2048) to 14'-8 1/2" (4483)
4-Panel, S3L/S3R	8'-8 1/4" (2648) to 19'-4 1/8" (5896)
5-Panel, S4L/S4R	10'-7 7/8" (3248) to 23'-11 3/4" (7309)
6-Panel, S5L/S5R	12'-7 5/8" (3851) to 25'-0" (7620)

• Shim space between unit dimension and rough opening is 1/2" (13) on each side.
• For detailed sizing information, visit andersenwindows.com/multiglide or contact your Andersen supplier.

ONE-DIRECTIONAL INTERIOR STACKING (L/R)

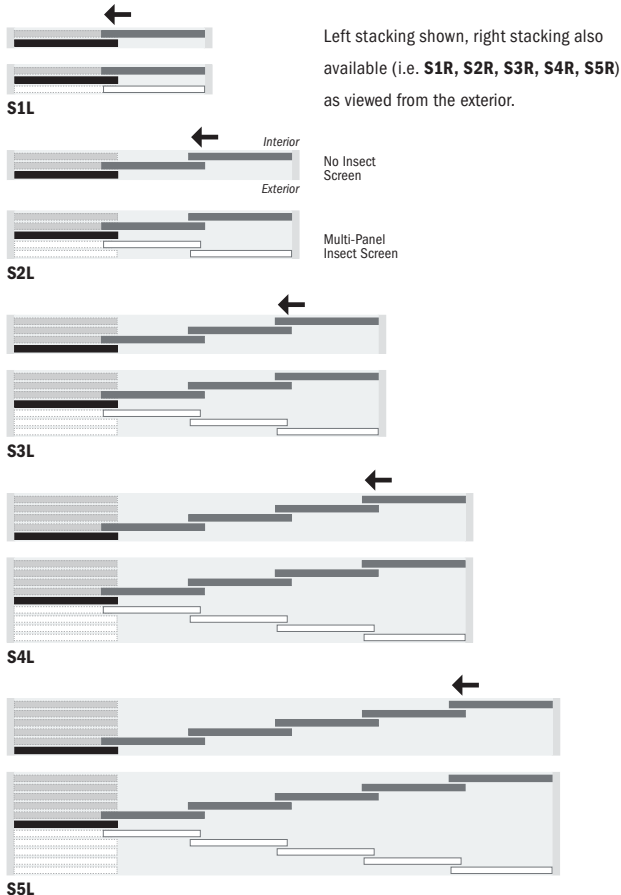

ONE-DIRECTIONAL EXTERIOR STACKING† (L/R)

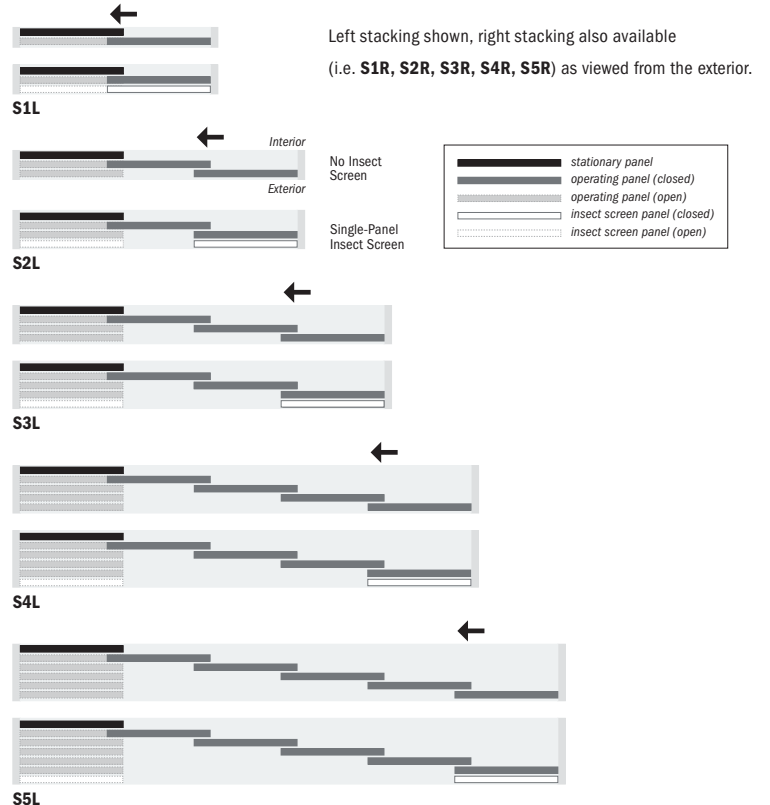

* Dimensions in parentheses are in millimeters.
† Exterior stacking option allows for the use of only one exterior insect screen on a multi-panel door, reducing jamb depth. Not tested for water performance.

MULTIGLIDE™ DOORS

TWO-DIRECTIONAL INTERIOR POCKETING*

Configurations

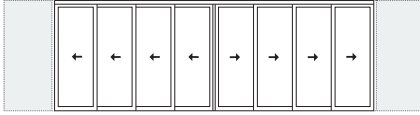

Two-Directional Interior Pocketing

Two-directional interior pocketing as viewed from the exterior. Number of panels and width dimensions vary based on panel style and configuration.† Flush sill and contemporary panels shown above, on-floor drainage sill and/or traditional panels also available. Details shown on pages 12 and 17-19.

JAMB DEPTHS**

Number of Panels & Handing	No Insect Screen	Single-Panel Insect Screen	Multi-Panel Insect Screen
2-Panel, 1L-1R	2 7/8" (73)	5 3/8" (137)	n/a
4-Panel, 2L-2R	5 3/8" (137)	7 7/8" (200)	10 3/8" (264)
6-Panel, 3L-3R	7 7/8" (200)	10 3/8" (264)	1'-3 3/8" (391)
8-Panel, 4L-4R	10 3/8" (264)	1'-0 7/8" (327)	1'-8 3/8" (518)

**On-floor drainage sill extends 3/4" (19) to the exterior, optional exterior ramp extends 2 1/16" (52) to the exterior and optional interior sill ramp extends 1 3/8" (35) to the interior.

CUSTOM WIDTHS (rough opening dimensions provided)

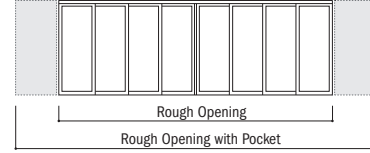

CONTEMPORARY PANELS

Number of Panels & Handing	Rough Opening Minimum to Maximum
2-Panel, 1L-1R	5'-0 1/4" (1530) to 10'-4 1/8" (3153)
	with pocket: 10'-4 1/2" (3162) to 21'-0 3/8" (6410)
4-Panel, 2L-2R	9'-3 7/8" (2842) to 16'-2" (4928)
	with pocket: 14'-8 3/4" (4489) to 25'-0" (7620)
6-Panel, 3L-3R	13'-7 1/2" (4153) to 18'-1" (5512)
	with pocket: 19'-0 1/2" (5804) to 25'-0" (7620)
8-Panel, 4L-4R	17'-11 1/8" (5464) to 19'-2 7/8" (5864)
	with pocket: 23'-4 1/4" (7118) to 25'-0" (7620)

TRADITIONAL PANELS

Number of Panels & Handing	Rough Opening Minimum to Maximum
2-Panel, 1L-1R	5'-0 1/4" (1530) to 10'-4 1/8" (3153)
	with pocket: 10'-4 1/2" (3162) to 21'-0 3/8" (6410)
4-Panel, 2L-2R	8'-11 5/8" (2734) to 16'-1" (4902)
	with pocket: 14'-4" (4369) to 25'-0" (7620)
6-Panel, 3L-3R	12'-10 7/8" (3934) to 17'-11 1/2" (5474)
	with pocket: 18'-3 1/8" (5566) to 25'-0" (7620)
8-Panel, 4L-4R	16'-10 1/4" (5137) to 19'-1" (5817)
	with pocket: 22'-2 1/2" (6769) to 25'-0" (7620)

- Shim space between unit dimension and rough opening is 1/2" (13) on each side.
- For detailed sizing information, visit andersenwindows.com/multiglide or contact your Andersen supplier.

TWO-DIRECTIONAL INTERIOR POCKETING CONFIGURATIONS

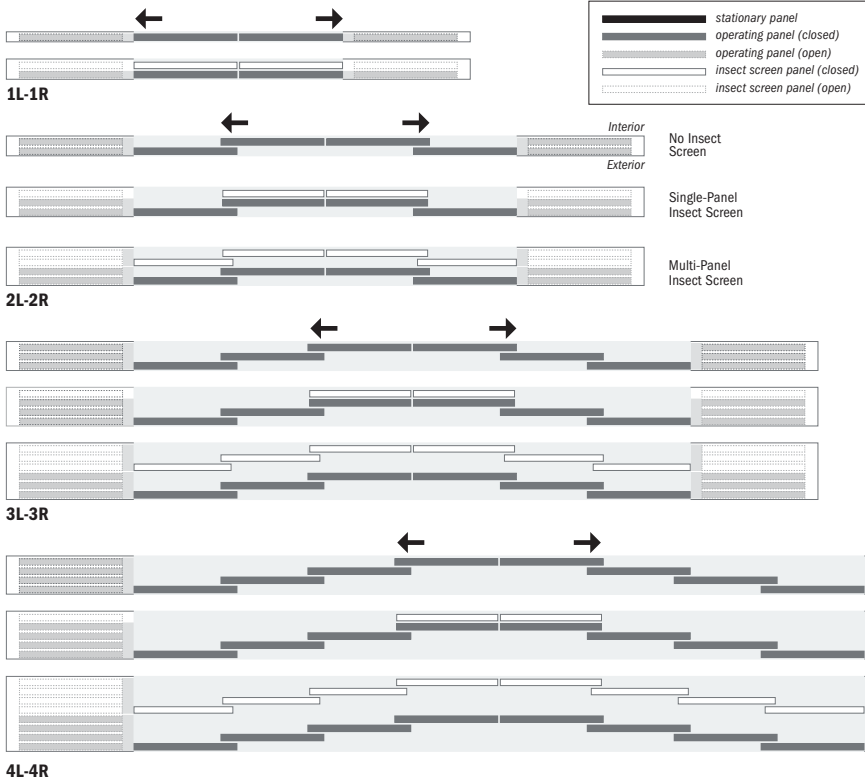

• Dimensions in parentheses are in millimeters.

*See your Andersen supplier for availability.

†Pocketing configurations default to one insect screen per pocket, reducing jamb depth. Multi-panel insect screens are an option to fill the entire opening.

ONE-DIRECTIONAL INTERIOR POCKETING (L/R)*

Configurations

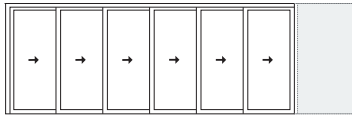

One Directional Interior Pocketing (R)

One-directional (left or right) interior pocketing as viewed from the exterior. Number of panels and width dimensions vary based on panel style and configuration.† Flush sill and contemporary panels shown above, on-floor drainage sill and/or traditional panels also available. Details shown on page 12 and 17-19.

JAMB DEPTHS**

Number of Panels & Handing	No Insect Screen	Single-Panel Insect Screen	Multi-Panel Insect Screen
1-Panel, 1L/1R	2 7/8" (73)	5 3/8" (137)	n/a
2-Panel, 2L/2R	5 3/8" (137)	7 7/8" (200)	10 3/8" (264)
3-Panel, 3L/3R	7 7/8" (200)	10 3/8" (264)	1'-3 3/8" (391)
4-Panel, 4L/4R	10 3/8" (264)	1'-0 7/8" (327)	1'-8 3/8" (518)
5-Panel, 5L/5R	1'-0 7/8" (327)	1'-3 3/8" (391)	2'-1 3/8" (645)
6-Panel, 6L/6R	1'-3 3/8" (391)	1'-5 7/8" (454)	2'-6 3/8" (772)

**On-floor drainage sill extends 3/4" (19) to the exterior, optional exterior ramp extends 2 1/16" (52) to the exterior and optional interior sill ramp extends 1 3/8" (35) to the interior.

CUSTOM WIDTHS (rough opening dimensions provided)

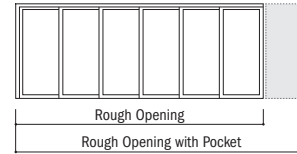

CONTEMPORARY PANELS	
Number of Panels & Handing	Rough Opening Minimum to Maximum
1-Panel, 1L/1R	2'-8 3/8" (822) to 5'-4 3/8" (1635) with pocket: 5'-4 1/2" (1638) to 10'-8 1/2" (3264)
2-Panel, 2L/2R	4'-10 1/4" (1480) to 10'-1 5/8" (3089) with pocket: 7'-6 3/4" (2305) to 15'-5 3/4" (4718)
3-Panel, 3L/3R	7'-0" (2134) to 14'-10 7/8" (4543) with pocket: 9'-8 1/2" (2959) to 20'-3" (6172)
4-Panel, 4L/4R	9'-1 7/8" (2791) to 19'-7 7/8" (5991) with pocket: 11'-10 1/2" (3620) to 25'-0" (7620)
5-Panel, 5L/5R	11'-3 5/8" (3445) to 20'-5 3/8" (6233) with pocket: 14'-0 1/4" (4274) to 25'-0" (7620)
6-Panel, 6L/6R	13'-5 1/2" (4102) to 21'-0 1/4" (6407) with pocket: 16'-2 1/8" (4931) to 25'-0" (7620)

ONE-DIRECTIONAL INTERIOR POCKETING (L/R)

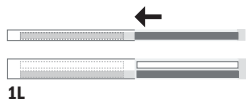

Left pocketing shown, right pocketing also available (i.e. **1R, 2R, 3R, 4R, 5R, 6R**) as viewed from the exterior.

1L

2L

3L

4L

5L

6L

Interior

Exterior

No Insect Screen

Single-Panel Insect Screen

Multi-Panel Insect Screen

stationary panel

operating panel (closed)

operating panel (open)

insect screen panel (closed)

insect screen panel (open)

TRADITIONAL PANELS	
Number of Panels & Handing	Rough Opening Minimum to Maximum
1-Panel, 1L/1R	2'-8 3/8" (822) to 5'-4 3/8" (1635) with pocket: 5'-4 1/2" (1638) to 10'-8 1/2" (3264)
2-Panel, 2L/2R	4'-8 1/8" (1426) to 10'-0" (3048) with pocket: 7'-4 3/8" (2245) to 15'-4 1/8" (4677)
3-Panel, 3L/3R	6'-7 3/4" (2026) to 14'-7 5/8" (4461) with pocket: 9'-4" (2845) to 19'-11 3/4" (6090)
4-Panel, 4L/4R	8'-7 3/8" (2626) to 19'-3 1/4" (5874) with pocket: 11'-3 1/2" (3442) to 24'-7 3/8" (7503)
5-Panel, 5L/5R	10'-7" (3226) to 20'-4 3/8" (6207) with pocket: 13'-3 1/8" (4042) to 25'-0" (7620)
6-Panel, 6L/6R	12'-6 3/4" (3829) to 20'-11 1/8" (6379) with pocket: 15'-2 7/8" (4645) to 25'-0" (7620)

• Shim space between unit dimension and rough opening is 1/2" (13) on each side.
• For detailed sizing information, visit andersenwindows.com/multiglide or contact your Andersen supplier.

• Dimensions in parentheses are in millimeters.

*See your Andersen supplier for availability.

†Pocketing configurations default to one insect screen per pocket, reducing jamb depth. Multi-panel insect screens are an option to fill the entire opening.

MULTIGLIDE™ DOORS

Design Criteria

For specific design, sizing and installation information, please visit andersenwindows.com/multiglide.

To allow for proper performance and operation, verify the structural integrity of the header such that the maximum deflection with live and dead loads is calculated using the L/750 criteria and 1/4" (6) as a maximum.

The lower surface of the header must be continuous and at a minimum 1 1/2" (38) of thickness to allow for proper embedment of installation screws. The surface dimensions are defined in the specifications of the "Site Preparation Information" via the link above.

Special consideration should be taken in the case of a window set above the opening header. An adequate structural header must be set between any window and the head of the MultiGlide™ door. No direct mulling can be done.

Weight of Door – The MultiGlide door system is a bottom-bearing door system. When considering structural requirements for subfloor, the dead load is 100 lbs/ft (149 kg/m). Deflection over the entire sill span cannot be greater than 1/8" (3).

Dead Loads – Dead loads MUST be applied to the structure prior to installation.

Live Loads – Live loads are dynamic and will vary per region, exposure, occupancy, etc. An engineer will engineer the structure around the door based on a worst-case or fully loaded (anticipated live and known dead load) condition. Live loads can be: snow, ice, water, wind, etc. Headers should be designed to accommodate a worst-case live load scenario.

Pocket Door Applications – For MultiGlide doors with pocketing, it is best to frame the interior pocket wall after door installation or to leave off sheathing for ease of installation.

Aluminum Frame

Aluminum clad panels shown. Aluminum panels also available.

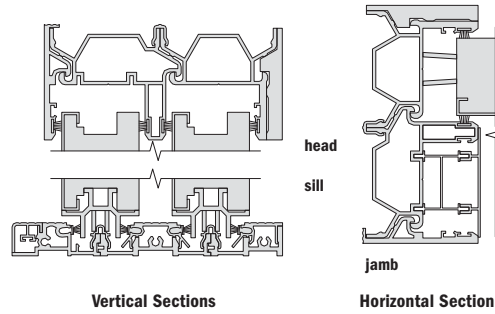

Thermally Controlled Frame

Aluminum clad panels shown, dark-colored area indicates pultruded components. Aluminum panels not available.

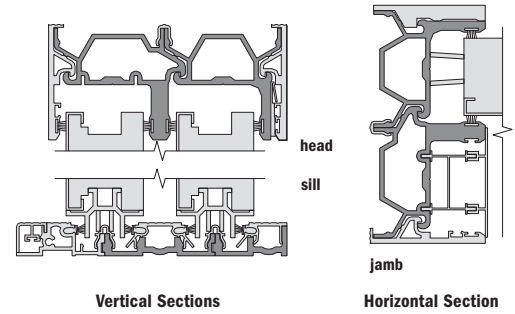

Sills and Panels

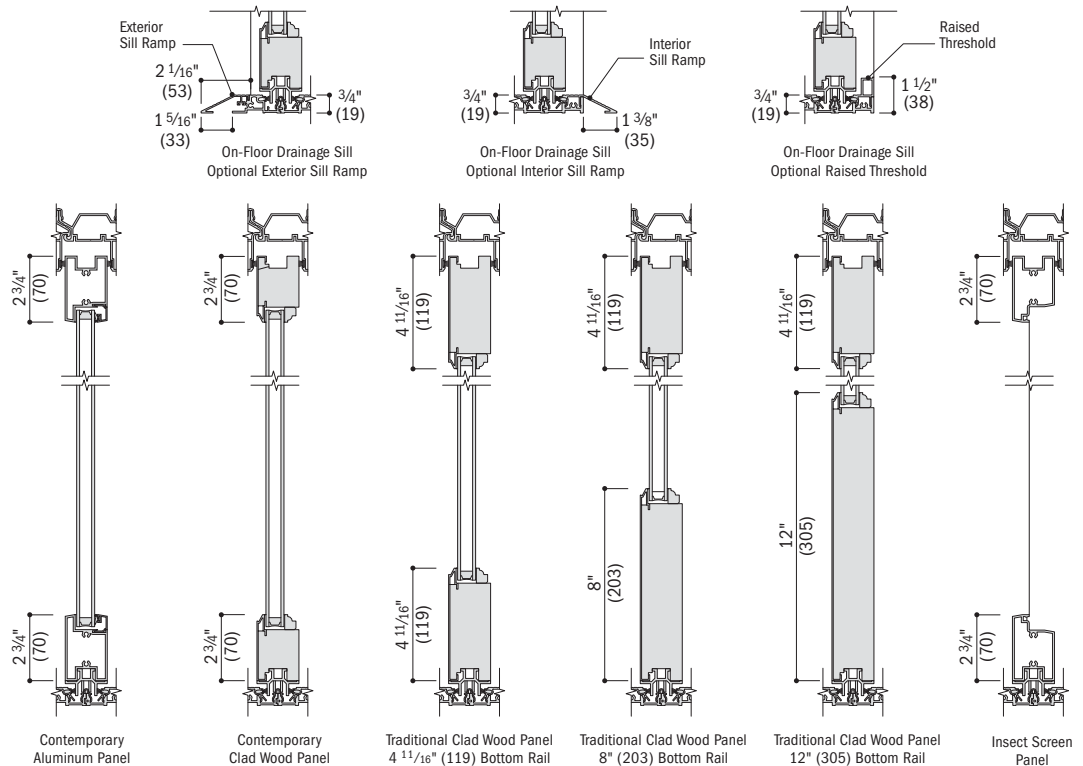

Vertical Sections

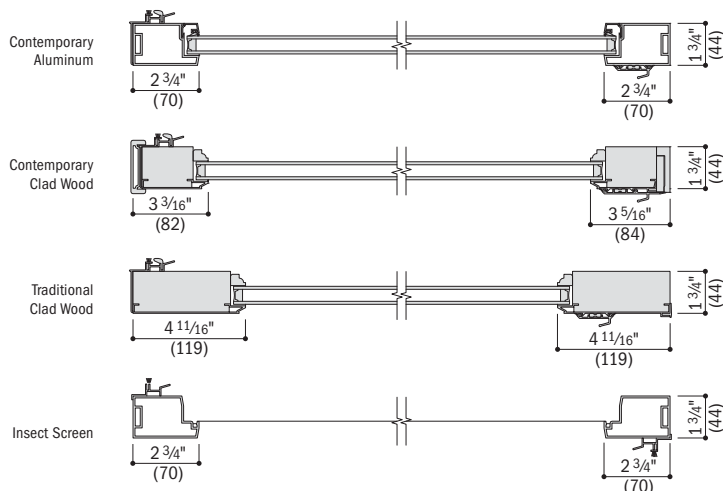

Horizontal Sections Intermediate Panels

• Dimensions in parentheses are in millimeters.



Interior Stacking, No Insect Screen with Contemporary Aluminum Panels

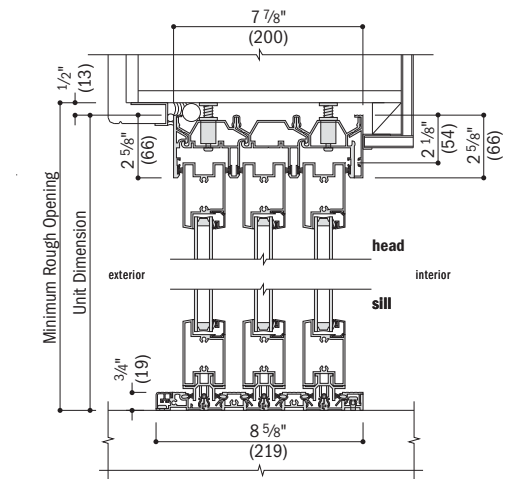

Vertical Section
On-Floor Drainage Sill
Three-Panel One-Directional

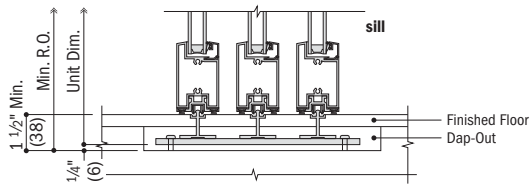

Vertical Section
Flush Sill
Three-Panel One-Directional

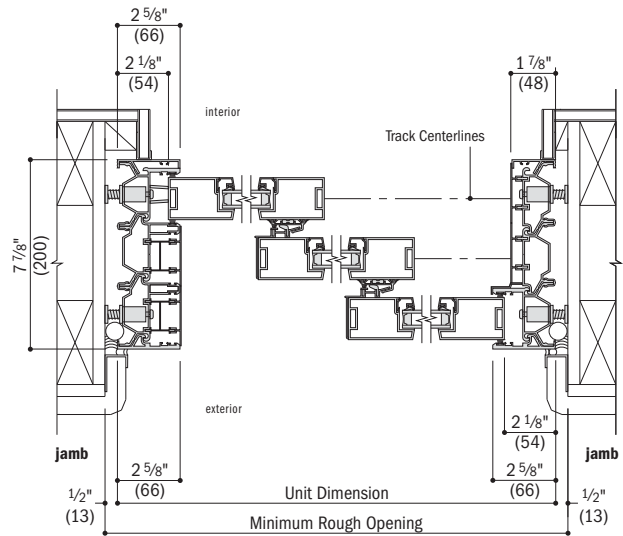

Horizontal Section
Three-Panel One-Directional

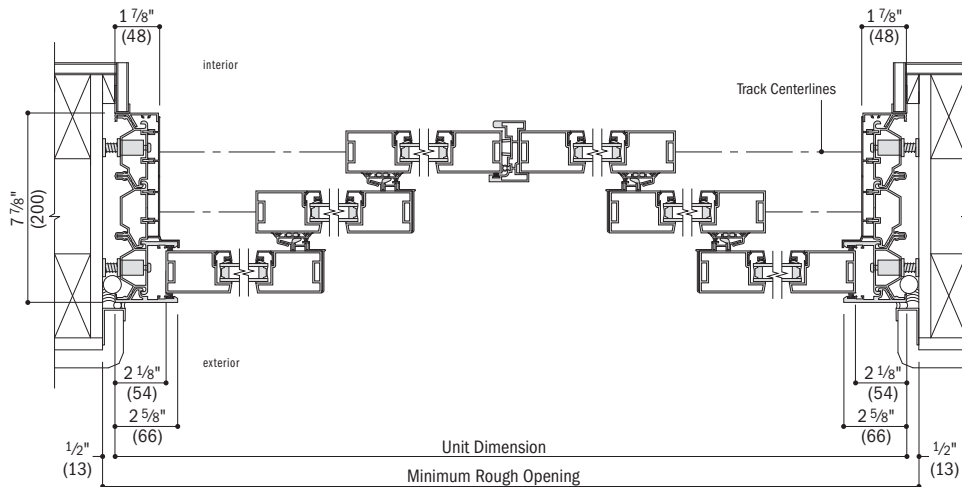

Horizontal Section
Six-Panel Two-Directional

- 7 7/8" (200) jamb depth measurement is from front side of door frame to backside of door frame.
- **Rough openings may need to be increased to allow for use of building wraps, flashing, sill panning, brackets, fasteners or other items. See installation information on page 20.**
- Details are for illustration only and are not intended to represent complete or appropriate product installation methods or materials for application. Refer to product installation guide.
- Dimensions in parentheses are in millimeters.
- Contemporary wood clad or traditional clad wood panel details are also available.

MULTIGLIDE™ DOORS

Interior Stacking with Contemporary Aluminum Panels, Multi-Panel Insect Screen

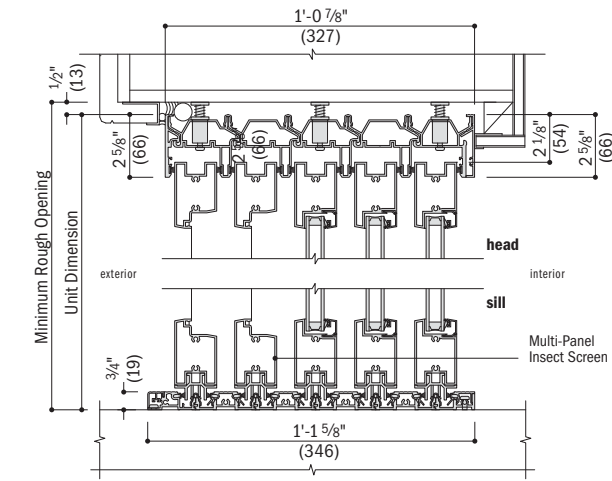

Vertical Section
On-Floor Drainage Sill
Three-Panel One-Directional

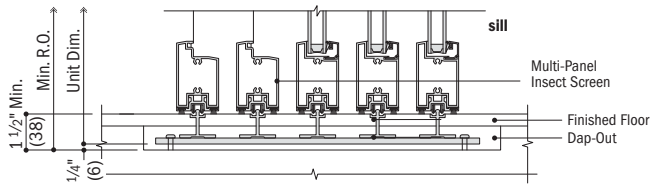

Vertical Section
Flush Sill
Three-Panel One-Directional

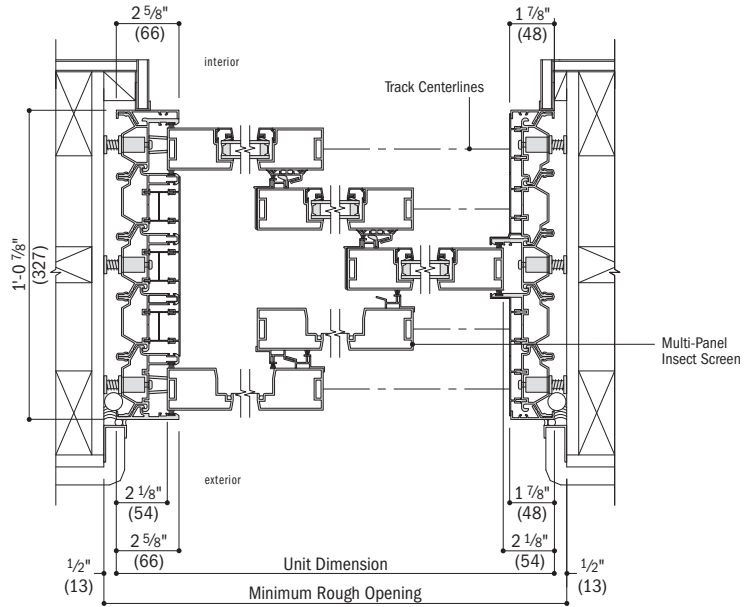

Horizontal Section
Three-Panel One-Directional

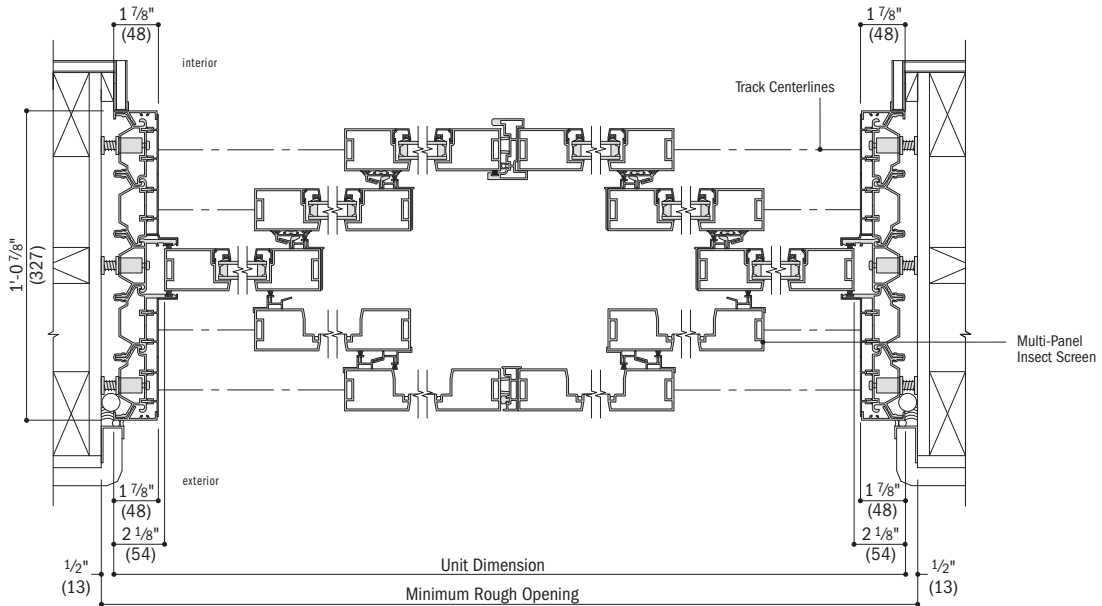

Horizontal Section
Six-Panel Two-Directional

- 1'-0 7/8" (327) jamb depth measurement is from front side of door frame to backside of door frame.
- **Rough openings may need to be increased to allow for use of building wraps, flashing, sill panning, brackets, fasteners or other items. See installation information on page 20.**
- Details are for illustration only and are not intended to represent complete or appropriate product installation methods or materials for application. Refer to product installation guide.
- Dimensions in parentheses are in millimeters.
- Contemporary wood clad or traditional clad wood panel details are also available.

Exterior Stacking with Contemporary Aluminum Panels, No Insect Screen

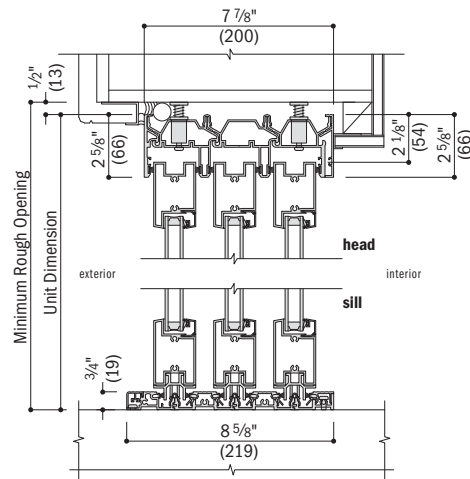

Vertical Section
On-Floor Drainage Sill
Three-Panel One-Directional

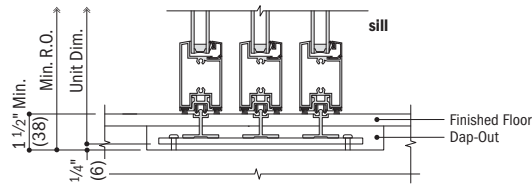

Vertical Section
Flush Sill
Three-Panel One-Directional

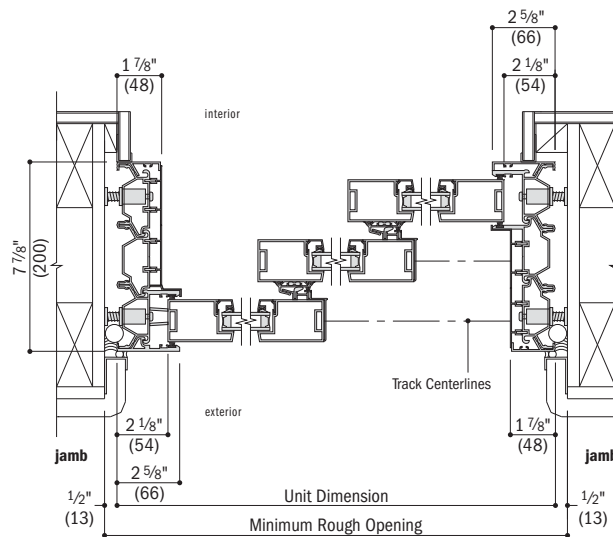

Horizontal Section
Three-Panel One-Directional

- 7 7/8" (200) jamb depth measurement is from front side of door frame to backside of door frame.
- **Rough openings may need to be increased to allow for use of building wraps, flashing, sill panning, brackets, fasteners or other items. See installation information on page 20.**
- Details are for illustration only and are not intended to represent complete or appropriate product installation methods or materials for application. Refer to product installation guide.
- Dimensions in parentheses are in millimeters.
- Contemporary wood clad or traditional clad wood panel details are also available.

MULTIGLIDE™ DOORS

Exterior Stacking with Contemporary Aluminum Panels, Single-Panel Insect Screen

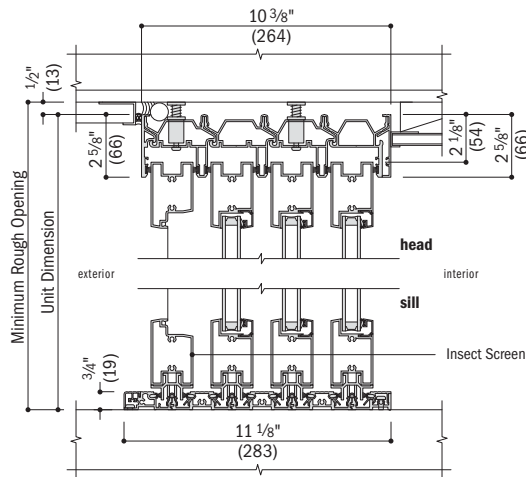

Vertical Section
On-Floor Drainage Sill
Three-Panel One-Directional

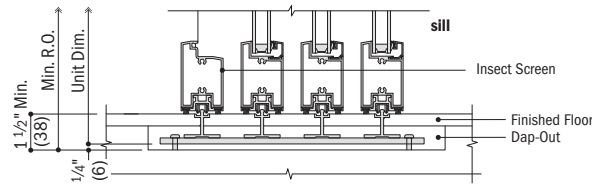

Vertical Section
Flush Sill
Three-Panel One-Directional

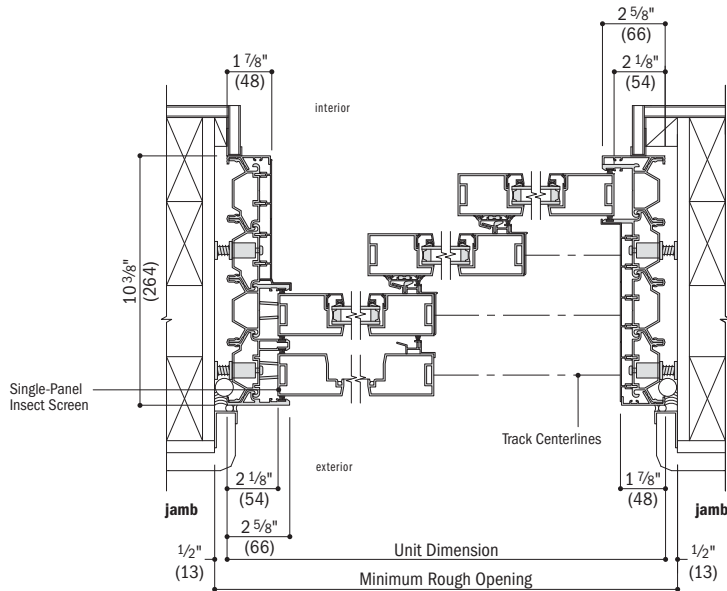

Horizontal Section
Three-Panel One-Directional

- 10 3/8" (264) jamb depth measurement is from front side of door frame to backside of door frame.
- **Rough openings may need to be increased to allow for use of building wraps, flashing, sill panning, brackets, fasteners or other items. See installation information on page 20.**
- Details are for illustration only and are not intended to represent complete or appropriate product installation methods or materials for application. Refer to product installation guide.
- Dimensions in parentheses are in millimeters.
- Contemporary wood clad or traditional clad wood panel details are also available.

Pocketing with Contemporary Aluminum Panels, No Insect Screen*

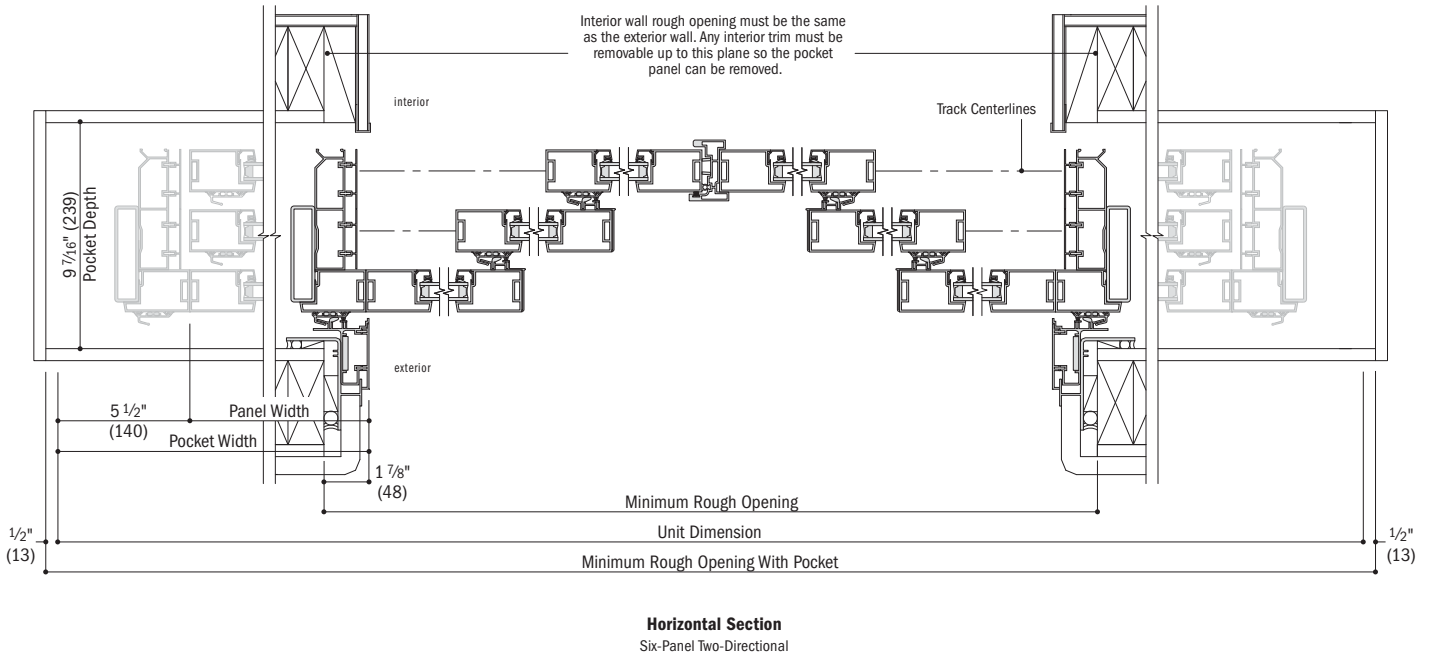
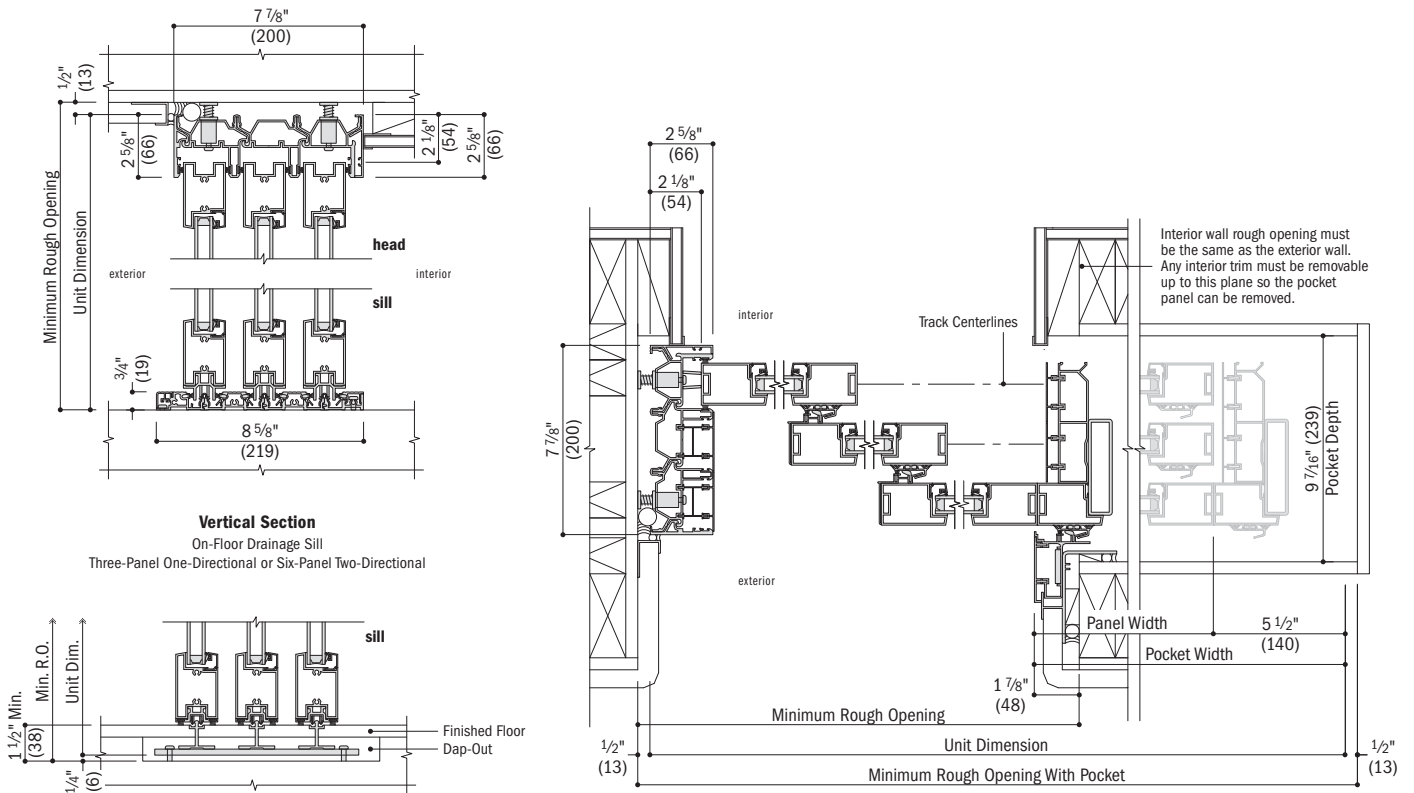

- 7 7/8" (200) jamb depth measurement is from front side of door frame to backside of door frame.
- **Rough openings may need to be increased to allow for use of building wraps, flashing, sill panning, brackets, fasteners or other items. See installation information on page 20.**
- Details are for illustration only and are not intended to represent complete or appropriate product installation methods or materials for application. Refer to product installation guide.
- Dimensions in parentheses are in millimeters.
- Contemporary wood clad or traditional clad wood panel details are also available.
- *See your Andersen supplier for availability.

MULTIGLIDE™ DOORS

Pocketing with Contemporary Aluminum Panels, Single-Panel Insect Screen*

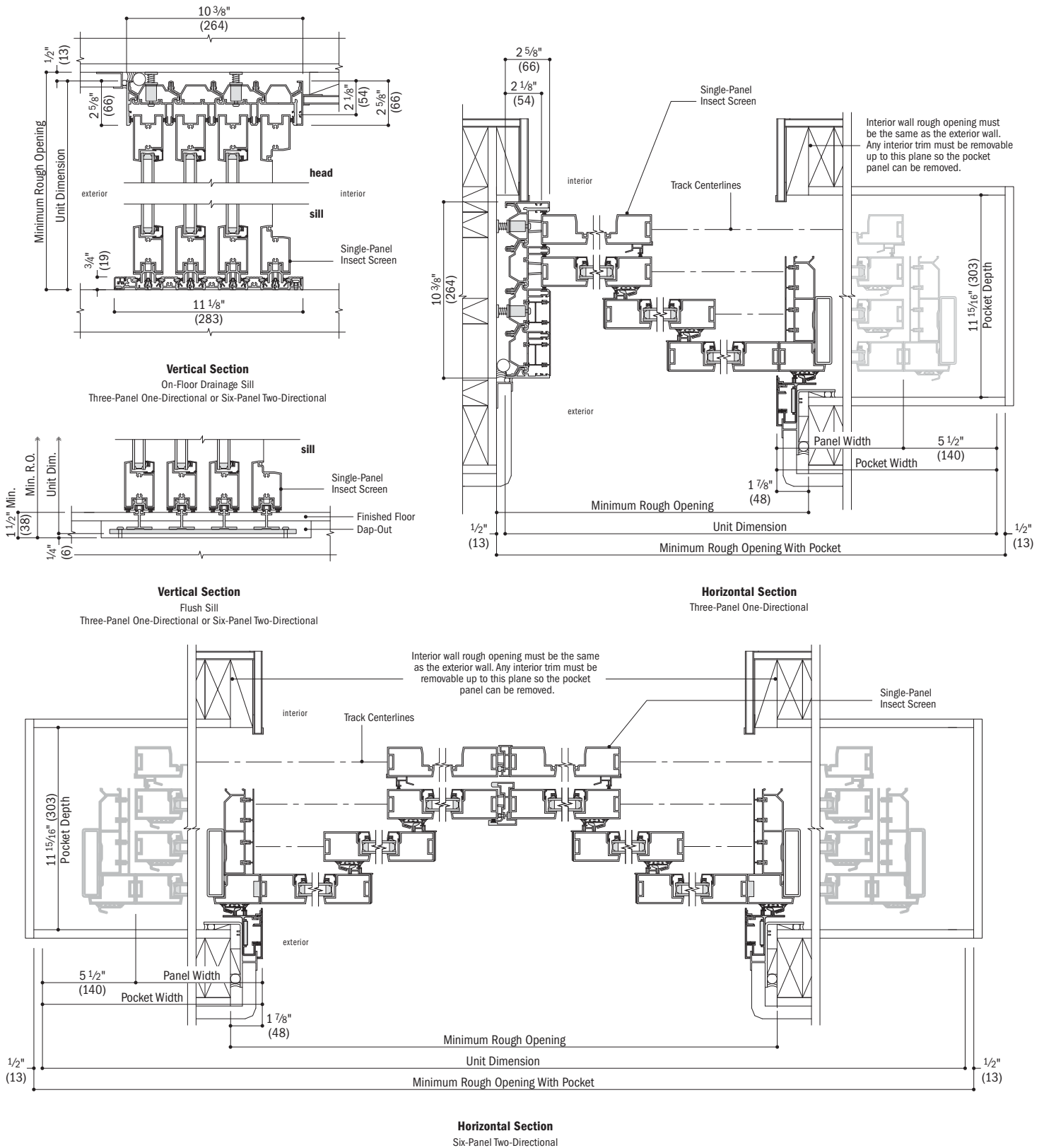

- 10 3/8" (264) (this page) and 1'-3 3/8" (391) (next page) jamb depth measurements are from front side of door frame to backside of door frame.
 - **Rough openings may need to be increased to allow for use of building wraps, flashing, sill panning, brackets, fasteners or other items. See installation information on page 20.**
 - Details are for illustration only and are not intended to represent complete or appropriate product installation methods or materials for application. Refer to product installation guide.
 - Dimensions in parentheses are in millimeters.
 - Contemporary wood clad or traditional clad wood panel details are also available.
- *See your Andersen supplier for availability.

Pocketing with Contemporary Aluminum Panels, Multi-Panel Insect Screen*

Footnotes on the previous page also apply to this page.

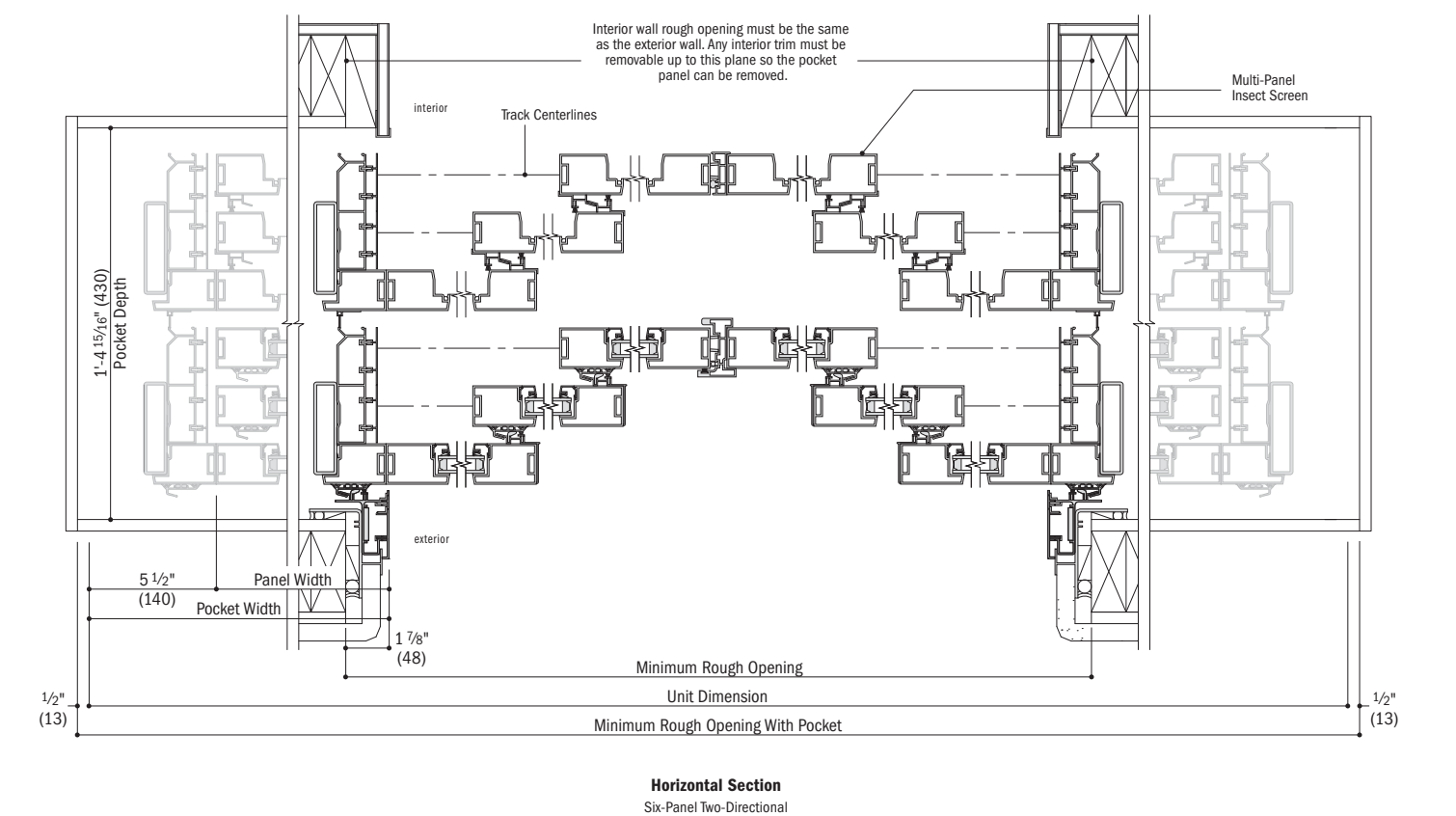
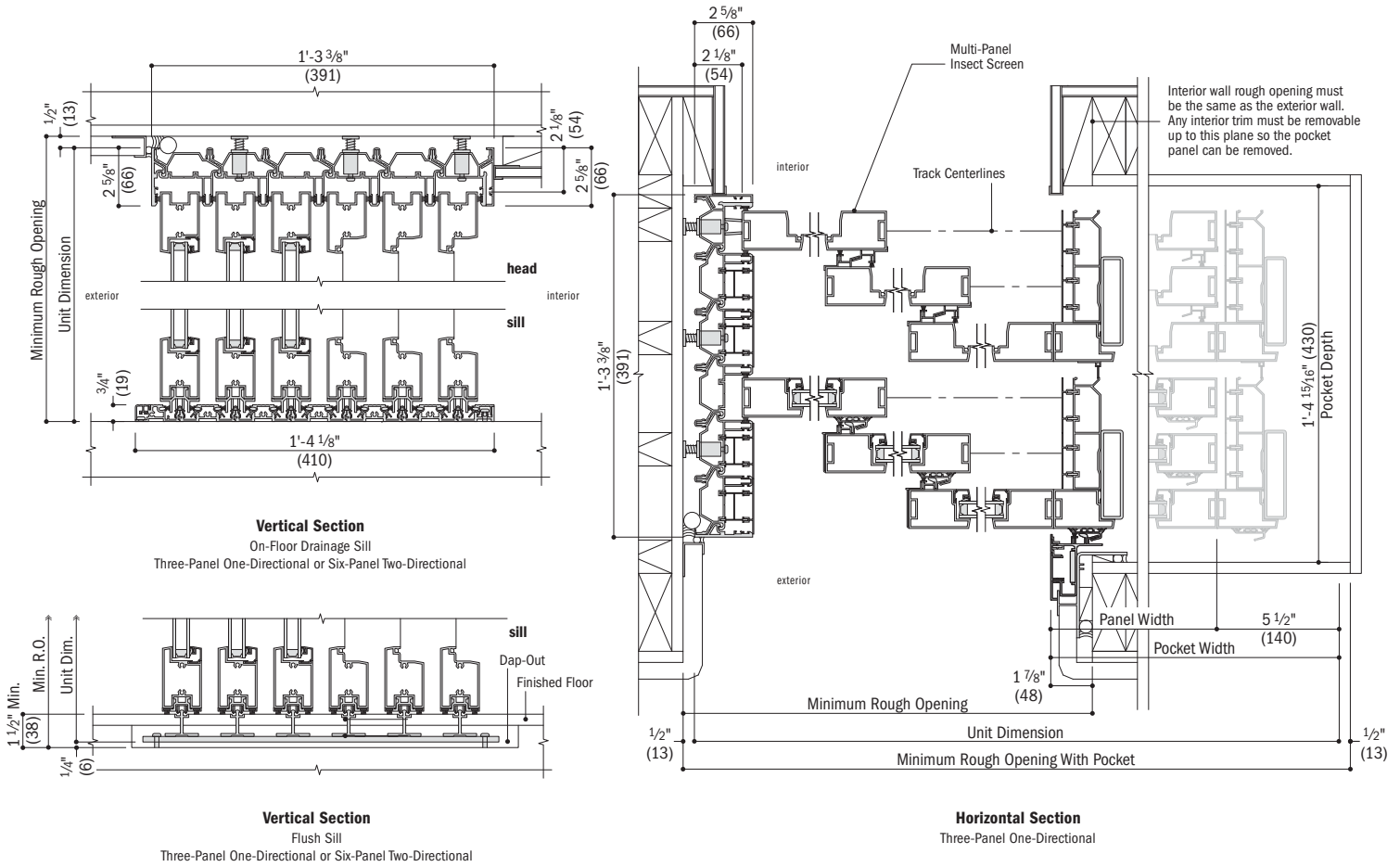

MULTIGLIDE™ DOORS

Performance Grade, Air Infiltration and Sound Transmission Ratings

For current performance information, please visit andersenwindows.com.

Andersen® Product	AAMA/WDMA/CSA 101/IS2/A440-08 and -11 Performance Grade (PG)	+/- Corresponding Design Pressure (DP)	Sound Transmission Class (STC)	Outdoor/Indoor Transmission Class (OITC)	Air Infiltration CFM/FT²
MultiGlide® Doors					
S1L-1RS*	Class LC-PG30 Size Tested 191.0" x 95.5"	30/30	29	24	< 0.2
S2L*	Class LC-PG30 Size Tested 178.8" x 95.5"	30/30	29	24	< 0.2
3R*	Class LC-PG30 Size Tested 191.0" x 119.5"	30/30	29	24	< 0.2

- *Performance Grade (PG) ratings may vary from tested performance rating for larger or smaller units of a particular type. Some units may not be rated.
- *Sound Transmission Class (STC) & "Outdoor/Indoor Transmission Class (OITC)" ratings are for individual units based on independent tests and represent entire unit.
- *This data is accurate as of May 2018. Due to ongoing product changes, updated test results or new industry standards, this data may change over time.
- *Where designated, Andersen® products are certified and labeled to the requirements of the Hallmark Certification Program. Actual performance may vary based on variations in manufacturing, shipping, installation, environmental conditions and conditions of use.
- *Contact your Andersen supplier for more information.
- *Values are for interior stacking doors. Contact your Andersen supplier for availability of exterior stacking door values.

Center of Glass Performance Data

For current performance information, please visit andersenwindows.com.

Glass Type	VT ¹	SC ²	SHGC ³	RHG ⁴	Fading		%RH @ center ⁷	IGST ⁸
					Tuv ⁵	Tdw ⁶		
High-Performance Dual-Pane Tempered Glass								
Low-E4®	72%	0.48	0.41	98.2	16%	33%	60.9%	55.7°F
Low-E4 Sun	40%	0.29	0.25	61.1	16%	24%	60.3%	55.4°F
Low-E4 SmartSun™	65%	0.31	0.27	65.6	5%	21%	61.8%	56.1°F
High-Performance Triple-Pane Tempered Glass								
Low-E4	66%	0.44	0.38	91.6	14%	30%	64.3%	57.2°F
Low-E4 SmartSun	59%	0.29	0.26	62.0	4%	19%	64.8%	57.4°F

- *"Low-E4™", "Low-E4 SmartSun™" and "Low-E4 Sun" are Andersen trademarks for "Low-E" glass.
- *Based on NFRC testing/simulation conditions using Windows v7.3.4.0 and NFRC validated spectral data. 0°F outside temperature, 70°F inside temperature and a 15 mph wind.
- 1) Visible Transmittance (VT) measures how much light comes through the glass. The higher the value, from 0 to 1, the more daylight the glass lets in. Visible Transmittance is measured over the 380 to 760 nanometer portion of the solar spectrum. 2) Shading Coefficient defines the amount of heat gain through the glass compared to a single lite of clear 1/8" (3 mm) glass. 3) Solar Heat Gain Coefficient (SHGC) defines the fraction of solar radiation admitted through the glass both directly transmitted and absorbed and subsequently released inward. The lower the value, the less heat is transmitted through the glass. 4) Relative Heat Gain is the amount of heat gain through a glazing incorporating U-Factor and Solar Heat Gain Coefficient. 5) Transmission Ultra-Violet Energy (TUV). The transmission of short-wave energy in the 300-380 nanometer portion of the solar spectrum. The energy can cause fabric fading. 6) Transmission Damage Function (TDW). The transmission of UV and visible light energy in the 300-600 nanometer portion of the solar spectrum. The value includes both the UV and visible light energy that can cause fabric fading. This rating has also been referred to as the Krochmann Damage Function. This rating better predicts fading potential than UV transmission alone. The lower the Damage Function rating, the less transmission of short-wave energy through the glass that can potentially cause fabric fading. Fabric type is also a key component of fading potential. 7) Percent relative humidity before condensation occurs at the center of glass, taken using center of glass temperature. 8) Inside glass surface temperatures are taken at the center of glass.
- *This data is accurate as of May 2018. Due to ongoing product changes, updated test results or new industry standards, this data may change over time. Contact your Andersen supplier for current performance information or upgrade options.
- *Contact your Andersen supplier or visit andersenwindows.com/nfrc for center of glass performance data on windows with laminated glass, patterned glass, tempered glass and products ordered with capillary breather tubes.

IMPORTANCE OF PROPER INSTALLATION

Proper installation and maintenance of Andersen products is essential to attain optimum performance and operation. Installation instructions that provide guidelines for proper installation are typically provided with Andersen products. They are also available by visiting andersenwindows.com. Remember that every installation is different, and Andersen strongly recommends consultation with the local supplier or an experienced contractor, architect or structural engineer prior to the installation of any Andersen product. The method of attachment for Andersen products, fastener selection and code compliance is the responsibility of the architect, building owner, contractor, installer and/or consumer. For more complete installation details, visit andersenwindows.com or see your Andersen supplier.

- *"Low-E4™", "Low-E4 SmartSun™", "Low-E4 Sun" and "HeatLock™" are Andersen trademarks for "Low-E" glass.
- 1) U-Factor defines the amount of heat loss through the total unit in BTU/hr/ft².°F. The lower the value, the less heat is lost through the entire product. Window values represent non-tempered glass. Use of tempered glass can increase U-Factor ratings. See andersenwindows.com/nfrc for specific performance values. Door values represent tempered glass. 2) Solar Heat Gain Coefficient (SHGC) defines the fraction of solar radiation admitted through the glass both directly transmitted and absorbed and subsequently released inward. The lower the value, the less heat is transmitted through the product. 3) Visible Transmittance (VT) measures how much light comes through a product (glass and frame). The higher the value, from 0 to 1, the more daylight the product lets in over the product's total unit area. Visible Transmittance is measured over the 380 to 760 nanometer portion of the solar spectrum.
- *NFRC ratings are based on modeling by a third-party agency as validated by an independent test lab in compliance with NFRC program and procedural requirements.
- *This data is accurate as of May 2018. Due to ongoing product changes, updated test results or new industry standards or requirements, this data may change over time. Ratings are for sizes specified by NFRC for testing and certification. Ratings may vary depending on unit size, use of tempered glass, different grille options, glass for high altitudes, etc.
- *Values are for single units with given pane thickness and 1" (25 mm) grilles for door products.

Andersen® NFRC Certified Total Unit Performance – Dual-Pane Glass

For current performance information, please visit andersenwindows.com.

Andersen® Product	High-Performance Tempered Glass Type	U-Factor ¹	SHGC ²	VT ³	
MultiGlide Door On-Floor Sill, Thermally Controlled Frame, Traditional Clad Wood Panel AND-N-156	Low-E4®	Without Grilles	0.30	0.27	0.46
		Simulated Divided Light Grilles	0.30	0.24	0.40
		Finelight™ Grilles	0.32	0.24	0.40
	Low-E4 w/HeatLock®	Full Divided Light Grilles	0.32	0.24	0.40
		Without Grilles	0.27	0.27	0.45
		Simulated Divided Light Grilles	0.27	0.23	0.39
	Low-E4 Sun	Finelight Grilles	0.28	0.23	0.39
		Full Divided Light Grilles	0.30	0.23	0.39
		Without Grilles	0.31	0.17	0.26
	Low-E4 SmartSun™	Simulated Divided Light Grilles	0.31	0.15	0.22
		Finelight Grilles	0.32	0.15	0.22
		Full Divided Light Grilles	0.32	0.15	0.22
	Low-E4 SmartSun w/HeatLock	Without Grilles	0.30	0.18	0.42
		Simulated Divided Light Grilles	0.30	0.16	0.36
		Finelight Grilles	0.31	0.16	0.36
	Low-E4 PassiveSun®	Full Divided Light Grilles	0.32	0.16	0.36
Without Grilles		0.26	0.18	0.41	
Simulated Divided Light Grilles		0.26	0.16	0.35	
Low-E4 PassiveSun®	Finelight Grilles	0.28	0.16	0.35	
	Full Divided Light Grilles	0.29	0.16	0.35	
	Without Grilles	0.31	0.45	0.51	
Low-E4 PassiveSun®	Simulated Divided Light Grilles	0.31	0.39	0.44	
	Finelight Grilles	0.32	0.39	0.44	
	Full Divided Light Grilles	0.33	0.39	0.44	

continued on next page

Andersen® NFRC Certified Total Unit Performance – Dual-Pane Glass

For current performance information, please visit andersenwindows.com. (continued)

Andersen® Product	High-Performance Tempered Glass Type	U-Factor ¹	SHGC ²	VT ³	
MultiGlide™ Door Flush Sill, Non Thermally Controlled Frame, Traditional Clad Wood Panel AND-N-158	Low-E4*	Without Grilles	0.40	0.28	0.46
		Simulated Divided Light Grilles	0.40	0.25	0.40
		Finelight™ Grilles	0.42	0.25	0.40
		Full Divided Light Grilles	0.42	0.25	0.40
	Low-E4 w/HeatLock™	Without Grilles	0.37	0.27	0.45
		Simulated Divided Light Grilles	0.37	0.24	0.39
		Finelight Grilles	0.38	0.24	0.39
		Full Divided Light Grilles	0.40	0.24	0.39
	Low-E4 Sun	Without Grilles	0.41	0.18	0.26
		Simulated Divided Light Grilles	0.41	0.16	0.22
		Finelight Grilles	0.42	0.16	0.22
		Full Divided Light Grilles	0.42	0.16	0.22
	Low-E4 SmartSun™	Without Grilles	0.40	0.19	0.42
		Simulated Divided Light Grilles	0.40	0.17	0.36
		Finelight Grilles	0.41	0.17	0.36
		Full Divided Light Grilles	0.42	0.17	0.36
	Low-E4 SmartSun w/HeatLock	Without Grilles	0.36	0.19	0.41
		Simulated Divided Light Grilles	0.36	0.16	0.35
		Finelight Grilles	0.38	0.16	0.35
		Full Divided Light Grilles	0.39	0.16	0.35
	Low-E4 PassiveSun™	Without Grilles	0.41	0.45	0.51
		Simulated Divided Light Grilles	0.41	0.40	0.44
		Finelight Grilles	0.42	0.40	0.44
		Full Divided Light Grilles	0.43	0.40	0.44
MultiGlide Door Flush Sill, Non Thermally Controlled Frame, Contemporary Aluminum Panel AND-N-157	Low-E4	Without Grilles	0.56	0.33	0.54
		Simulated Divided Light Grilles	0.56	0.29	0.47
		Finelight Grilles	0.57	0.29	0.47
		Full Divided Light Grilles	0.58	0.29	0.47
	Low-E4 w/HeatLock	Without Grilles	0.52	0.32	0.53
		Simulated Divided Light Grilles	0.52	0.29	0.46
		Finelight Grilles	0.53	0.29	0.46
		Full Divided Light Grilles	0.55	0.29	0.46
	Low-E4 Sun	Without Grilles	0.56	0.21	0.30
		Simulated Divided Light Grilles	0.56	0.18	0.26
		Finelight Grilles	0.58	0.18	0.26
		Full Divided Light Grilles	0.58	0.18	0.26
Low-E4 SmartSun	Without Grilles	0.55	0.22	0.48	
	Simulated Divided Light Grilles	0.55	0.20	0.42	
	Finelight Grilles	0.57	0.20	0.42	
	Full Divided Light Grilles	0.57	0.20	0.42	
Low-E4 SmartSun w/HeatLock	Without Grilles	0.51	0.22	0.47	
	Simulated Divided Light Grilles	0.51	0.19	0.41	
	Finelight Grilles	0.53	0.19	0.41	
	Full Divided Light Grilles	0.55	0.19	0.41	
Low-E4 PassiveSun	Without Grilles	0.57	0.53	0.59	
	Simulated Divided Light Grilles	0.57	0.47	0.52	
	Finelight Grilles	0.58	0.47	0.52	
	Full Divided Light Grilles	0.58	0.47	0.52	

Andersen® Product	High-Performance Tempered Glass Type	U-Factor ¹	SHGC ²	VT ³	
<i>triple-pane glass continued</i>					
MultiGlide Door On-Floor Sill, Thermally Controlled Frame, Traditional Clad Wood Panel AND-N-156	Low-E4 SmartSun Enhanced	Without Grilles	0.25	0.17	0.37
		Simulated Divided Light Grilles	0.25	0.15	0.32
		Finelight Grilles	-	-	-
		Full Divided Light Grilles	-	-	-
	Low-E4 SmartSun Enhanced w/ HeatLock	Without Grilles	0.23	0.16	0.36
		Simulated Divided Light Grilles	0.23	0.14	0.31
		Finelight Grilles	-	-	-
		Full Divided Light Grilles	-	-	-
	Low-E4	Without Grilles	0.38	0.26	0.42
		Simulated Divided Light Grilles	0.35	0.23	0.36
		Finelight Grilles	-	-	-
		Full Divided Light Grilles	-	-	-
Low-E4 Enhanced	Without Grilles	0.35	0.25	0.41	
	Simulated Divided Light Grilles	0.35	0.22	0.35	
	Finelight Grilles	-	-	-	
	Full Divided Light Grilles	-	-	-	
Low-E4 Enhanced w/HeatLock	Without Grilles	0.33	0.24	0.40	
	Simulated Divided Light Grilles	0.33	0.21	0.34	
	Finelight Grilles	-	-	-	
	Full Divided Light Grilles	-	-	-	
MultiGlide Door Flush Sill, Non Thermally Controlled Frame, Traditional Clad Wood Panel AND-N-158	Low-E4 SmartSun	Without Grilles	0.38	0.18	0.38
		Simulated Divided Light Grilles	0.38	0.16	0.33
		Finelight Grilles	-	-	-
		Full Divided Light Grilles	-	-	-
	Low-E4 SmartSun Enhanced	Without Grilles	0.35	0.17	0.37
		Simulated Divided Light Grilles	0.35	0.15	0.32
		Finelight Grilles	-	-	-
		Full Divided Light Grilles	-	-	-
	Low-E4 SmartSun Enhanced w/ HeatLock	Without Grilles	0.33	0.17	0.36
		Simulated Divided Light Grilles	0.33	0.15	0.31
		Finelight Grilles	-	-	-
		Full Divided Light Grilles	-	-	-
MultiGlide Door Flush Sill, Non Thermally Controlled Frame, Contemporary Aluminum Panel AND-N-157	Low-E4	Without Grilles	0.53	0.30	0.49
		Simulated Divided Light Grilles	0.53	0.27	0.43
		Finelight Grilles	-	-	-
		Full Divided Light Grilles	-	-	-
	Low-E4 Enhanced	Without Grilles	0.49	0.30	0.47
		Simulated Divided Light Grilles	0.49	0.26	0.41
		Finelight Grilles	-	-	-
		Full Divided Light Grilles	-	-	-
	Low-E4 Enhanced w/HeatLock	Without Grilles	0.47	0.29	0.46
		Simulated Divided Light Grilles	0.47	0.25	0.40
		Finelight Grilles	-	-	-
		Full Divided Light Grilles	-	-	-
Low-E4 SmartSun	Without Grilles	0.52	0.21	0.44	
	Simulated Divided Light Grilles	0.52	0.19	0.39	
	Finelight Grilles	-	-	-	
	Full Divided Light Grilles	-	-	-	
Low-E4 SmartSun Enhanced	Without Grilles	0.49	0.20	0.43	
	Simulated Divided Light Grilles	0.49	0.18	0.37	
	Finelight Grilles	-	-	-	
	Full Divided Light Grilles	-	-	-	
Low-E4 SmartSun Enhanced w/ HeatLock	Without Grilles	0.47	0.20	0.42	
	Simulated Divided Light Grilles	0.47	0.18	0.36	
	Finelight Grilles	-	-	-	
	Full Divided Light Grilles	-	-	-	

Andersen® NFRC Certified Total Unit Performance – Triple-Pane Glass

For current performance information, please visit andersenwindows.com.

Andersen® Product	High-Performance Tempered Glass Type	U-Factor ¹	SHGC ²	VT ³	
MultiGlide Door On-Floor Sill, Thermally Controlled Frame, Traditional Clad Wood Panel AND-N-156 <i>continued</i>	Low-E4	Without Grilles	0.28	0.25	0.42
		Simulated Divided Light Grilles	0.28	0.22	0.36
		Finelight Grilles	-	-	-
		Full Divided Light Grilles	-	-	-
	Low-E4 Enhanced	Without Grilles	0.25	0.25	0.41
		Simulated Divided Light Grilles	0.25	0.22	0.35
		Finelight Grilles	-	-	-
		Full Divided Light Grilles	-	-	-
	Low-E4 Enhanced w/HeatLock	Without Grilles	0.23	0.24	0.40
		Simulated Divided Light Grilles	0.23	0.21	0.34
		Finelight Grilles	-	-	-
		Full Divided Light Grilles	-	-	-
	Low-E4 SmartSun	Without Grilles	0.28	0.17	0.38
		Simulated Divided Light Grilles	0.28	0.15	0.33
		Finelight Grilles	-	-	-
		Full Divided Light Grilles	-	-	-

- "Low-E4*", "Low-E4" SmartSun™, "Low-E4" Sun" and "HeatLock™" are Andersen trademarks for "Low-E" glass.
- 1) U-Factor defines the amount of heat loss through the total unit in BTU/hr/ft². °F. The lower the value, the less heat is lost through the entire product. Window values represent non-tempered glass. Use of tempered glass can increase U-Factor ratings. See andersenwindows.com/nfrc for specific performance values. Door values represent tempered glass.
- 2) Solar Heat Gain Coefficient (SHGC) defines the fraction of solar radiation admitted through the glass both directly transmitted and absorbed and subsequently released inward. The lower the value, the less heat is transmitted through the product.
- 3) Visible Transmittance (VT) measures how much light comes through a product (glass and frame). The higher the value, from 0 to 1, the more daylight the product lets in over the product's total unit area. Visible Transmittance is measured over the 380 to 760 nanometer portion of the solar spectrum.
- NFRC ratings are based on modeling by a third-party agency as validated by an independent test lab in compliance with NFRC program and procedural requirements.
- This data is accurate as of May 2018. Due to ongoing product changes, updated test results or new industry standards or requirements, this data may change over time. Ratings are for sizes specified by NFRC for testing and certification. Ratings may vary depending on unit size, use of tempered glass, different grille options, glass for high altitudes, etc.
- Values are for single units with given pane thickness and 1" (25mm) grilles for door products.

MULTIGLIDE™ DOORS



Limited Warranty

MultiGlide™ Door

**OWNER2OWNER
LIMITED WARRANTY**

Para ver la versión, en español, de esta Garantía limitada y Proceso de resolución de controversias, visite andersenwindows.com

LIMITED WARRANTY AND DISPUTE RESOLUTION PROCESS

IMPORTANT: Please carefully read the Dispute Resolution Process that appears in this document after the Limited Warranty. The Dispute Resolution Process includes class action and jury trial waivers that affect your legal rights. To opt out of these waivers, you must visit our website at www.andersenwindows.com/optout and complete the opt-out form within one year from the date of purchase of your Andersen® products from a dealer or retailer. The opt-out only applies to the terms of the Dispute Resolution Process.

Andersen® MultiGlide™ Doors Limited Warranty

Transferable Limited Warranty on Glass

The glass in Andersen® factory glazed doors (including dual-pane glass, High-Performance Low-E4® glass, High-Performance Low-E4® Sun glass, High-Performance Low-E4® SmartSun™ glass, High-Performance Low-E4® PassiveSun® glass, Heatlock® glass, Low-E glass, patterned glass, Finelight™ grilles, divided light grilles and tempered versions of these glass options is warranted to be free from defects in manufacturing, materials and workmanship for twenty (20) years from the date of purchase from the retailer/dealer. It is also warranted not to develop, under normal conditions, any material obstruction of vision resulting from manufacturing defects or as a result of premature failure of the glass or organic seal for twenty (20) years from the date of purchase from the retailer/dealer. This limited warranty on glass does not apply to special order glazings, impact-resistant glass, or glass that is not factory installed by Andersen.

In the event a glass failure occurs as a result of a defect in manufacturing, materials or workmanship within the limited warranty period, Andersen, at its option, will: (1) provide the appropriate replacement glass product to the Andersen retailer/dealer you specify — labor is not included; (2) provide a factory-authorized repair to the existing glass at no cost to you; or (3) refund the original purchase price. Such replacement parts or repair are warranted for the remainder of the original limited warranty period.

Transferable Limited Warranty on Components Other Than Glass

Non-glass portions of Andersen® doors (including non-electric operators, locks, lifts, hinges, handles, insect screens, weatherstripping, exterior trim, panel and frame members) are warranted to be free from defects in manufacturing, materials and workmanship for a period of ten (10) years from the date of purchase from the retailer/dealer. This limited warranty does not apply to finishes on satin nickel door hardware.

In the event a component other than glass fails as a result of a defect in manufacturing, materials or workmanship within the limited warranty period, Andersen, at its option, will: (1) provide replacement parts to the Andersen retailer/dealer you specify — labor is not included; (2) provide a factory-authorized repair to the existing component at no cost to you; or (3) refund the original purchase price. Such replacement parts or repairs are warranted for the remainder of the original limited warranty period.

Transferable Limited Warranty on Exterior Painted Aluminum Surfaces

The exterior painted aluminum surface (silicone polyester enamel conforming to AAMA 2604-05 ("2604 Coating System")) on components including frame, panel and grilles on Andersen MultiGlide doors in standard colors is warranted not to crack, chip, peel, flake, blister or lose adhesion for a period of twenty (20) years from the date of purchase from the retailer/dealer when exposed to normal atmospheric conditions. The paint film is warranted to be free from manufacturing defects resulting in color fade greater than 5 delta E* in accordance with ASTM D-2244-02e1 and chalking in excess of a number eight (8) rating based on ASTM D 4214-98 for a period of ten (10) years from the date of purchase from the retailer/dealer when exposed to normal atmospheric conditions.

The exterior painted aluminum surface (silicone polyester enamel with Kynar® fluorocarbon coating system conforming to AAMA 2605-05 ("2605 Coating System")) on components including frame, panel and grilles on Andersen MultiGlide doors in standard colors is warranted not to

crack, chip, peel, flake, blister or lose adhesion for a period of twenty (20) years from the date of purchase from the retailer/dealer when exposed to normal atmospheric conditions. The paint film is warranted to be free from manufacturing defects resulting in color fade greater than 5 delta E in accordance with ASTM D-2244-02e1 and chalking in excess of a number eight (8) rating based on ASTM D 4214-98 for twenty (20) years from the date of purchase from the retailer/dealer when exposed to normal atmospheric conditions.

In the event a failure occurs as a result of a defect in manufacturing, materials or workmanship within the limited warranty period, Andersen, at its option, will: (1) refinish the product (the finish will be performed with standard commercial refinishing techniques and will not necessarily be the same finish as originally applied to the product); (2) repair the product or provide replacement part(s) or product(s) — labor is not included; or (3) refund the original purchase price. Such replacement parts or repairs are warranted for the remainder of the original limited warranty period.

Exclusions: Accessories and hardware, including insect screen frames, patio door sills, hinges, handle trim sets and lock components, exterior trim profiles, exterior aluminum coil stock, anodized finishes and patio door insert panels. Products subjected to the detrimental effects of air pollutants, chemical or caustic washes, or the accumulation of concentrated salt deposits are not covered by the terms of this limited warranty. Any scratches, chips or surface damage that would expose the aluminum cladding surface must be repaired immediately, and such repair is required to maintain limited warranty coverage.

Paint performance may vary based on product orientation, altitude, installation in heavy salt spray environments, and other atmospheric conditions. Regular maintenance of the product is required to maintain the appearance of the finish on clad units, including hardware, and is required to maintain limited warranty coverage.

* Technical measurement of fade

Transferable Limited Warranty on Exterior Anodized Aluminum Surfaces

The anodized finish on Andersen MultiGlide aluminum cladding in standard colors is warranted not to crack, craze, flake or blister for five (5) years from the date of purchase from the retailer/dealer when exposed to normal atmospheric conditions. The anodized finish is also warranted against chalking in excess of a number eight (8) rating as determined by the procedure outlined in ASTM D-4214-98 specification tests and against color change of more than 5 delta-E* units as determined by ASTM method D-2244-02e1 for five (5) years from the date of manufacture.

In the event a failure occurs as a result of a defect in manufacturing, materials or workmanship within the limited warranty period, Andersen, at its option, will: (1) refinish the product (the finish will be performed with standard commercial refinishing techniques and will not necessarily be the same finish as originally applied to the product); (2) repair the product or provide replacement part(s) or product(s) — labor is not included; or (3) refund the original purchase price. Such replacement parts or repairs are warranted for the remainder of the original limited warranty period.

* Technical measurement of fade

Transferable Limited Warranty on Automation

Automation components of Andersen MultiGlide doors (including motor, control box, hardware, touch screen, interior motion sensor, exterior motion sensor, and exterior wall box and keypad) are warranted to be free from defects in manufacturing, materials and workmanship for a period of five (5) years from the date of purchase from the retailer/dealer. Batteries are excluded.

In the event an automation component fails as a result of a defect in manufacturing, materials or workmanship within the limited warranty period, Andersen, at its option, will: (1) provide replacement parts to the Andersen retailer/dealer you specify — labor is not included; (2) provide a factory-authorized repair to the existing component at no cost to you; or (3) refund the original purchase price. Such replacement parts or repairs are warranted for the remainder of the original limited warranty period.

No Other Warranties or Representations

THIS LIMITED WARRANTY IS IN LIEU OF ALL OTHER WARRANTIES, EXPRESS OR IMPLIED, INCLUDING, BUT NOT LIMITED TO, ANY IMPLIED WARRANTIES OF MERCHANTABILITY OR FITNESS FOR A PARTICULAR PURPOSE. ALL WARRANTIES ARE LIMITED TO THE APPLICABLE STATUTE OF LIMITATIONS, BUT IN NO CASE WILL EXTEND BEYOND THE LIMITED WARRANTY PERIODS SPECIFIED ABOVE. ANDERSEN EXCLUDES AND WILL NOT BE LIABLE FOR ANY INCIDENTAL OR CONSEQUENTIAL DAMAGES, WHETHER ARISING OUT OF CONTRACT, TORT OR OTHERWISE. THE REMEDY OF REPAIR, REPLACEMENT OR REFUND OF THE ACTUAL PURCHASE PRICE OF THE PRODUCT PROVIDED BY THIS LIMITED WARRANTY IS THE EXCLUSIVE REMEDY WITH RESPECT TO ANY AND ALL LOSS OR DAMAGE.

Applicable Law

This Limited Warranty is only applicable in the U.S.A. (i.e., the fifty states and the District of Columbia). This Limited Warranty gives you specific legal rights, and you may also have other rights which may vary from state to state. Some states do not allow the exclusion or limitation of incidental or consequential damages or limitation of the duration of an implied warranty, so the above limitations or exclusions may not apply to you. If any specific term of this Limited Warranty is prohibited by any applicable law, it shall be null and void, but the remainder of this Limited Warranty shall remain in full force and effect.

What is NOT covered by this Limited Warranty: Specific Additional Exclusions

In addition to any other limitations or exclusions in this Limited Warranty, Andersen shall have no obligation for product failure, damage or costs due to or related to the following:

- Product modifications or glass shading devices (e.g., glass tinting, security systems, improper painting or staining, insulated coverings, etc.).
- Units improperly assembled or improperly mulled by others.
- Failure due to the application of hardware not offered by Andersen (e.g., locksets, trim sets, hinges, panic hardware, closers, etc.).
- Failure to properly install Andersen hardware and/or exterior trim.
- Adjustments or corrections due to improper installation.
- Improper installation or use, including use of a non-commercial door as a main entrance or exit door for a building other than a single-family residential unit or re-installing an Andersen window or door after it has been removed from a building and re-sold and/or re-installed in a different building.
- Exposure to conditions beyond published performance specifications.
- Water infiltration other than as a result of a defect in manufacturing, materials or workmanship.
- Condensation.
- Improper maintenance, such as use of brick wash, razor blades, sealants, sanding or improper washing.
- Failing to properly seal and maintain the exposed wood portions of a product. This includes, but is not limited to, the exposed wood on all sides of a door panel (e.g., exterior, interior, top, bottom, and both sides), a door frame and wood grilles.
- Chemicals or airborne pollutants, such as salt or acid rain.
- Delivery by others.
- Accidents.
- Acts of God.
- Normal wear and tear.

Additional items excluded from this limited warranty:

- Labor to replace door panels, glass or other components.
- Labor and other costs related to the removal and disposal of defective product.
- Labor and materials to paint or stain any repaired or replaced product, component, trim or other carpentry work that may be required.
- Products not manufactured by Andersen.
- The performance of the low-maintenance exterior glass coating on products with High-Performance Low-E4® glass. Performance will vary depending on environmental conditions.
- Minor warping of clad-wood doors. Andersen may defer actions on any claim for warping for a period of up to twelve (12) months from the date of the claim in order to permit conditioning and equalization to humidity and temperature conditions.
- Slight glass curvature, minor scratches or other imperfections in the glass that do not impair structural integrity or significantly obscure normal vision.
- Rattling of grille bars within an air space.
- Insects passing through or around the insect screen.
- Tarnish or corrosion to hardware finishes.
- Stress cracks and broken glass.
- Special glazings. Contact us concerning the limited warranty on special glazings.
- Retractable insect screens, satin nickel finishes on door hardware and VeriLock® sensors. Contact us or refer to the specific limited warranties for these products.
- Andersen® 400/200 Series windows and doors, Andersen 400 Series windows with Stormwatch® protection and with impact-resistant glass, A-Series windows and doors, E-Series windows and doors, 100 Series windows and doors, storm doors, Renewal by Andersen® windows, Silver Line® windows and doors, American Craftsman® windows and doors and Weiland® windows and doors have their own limited warranties and are not covered by this limited warranty.
- Service trips to provide instruction on product use.

How to register your Owner-To-Owner® Limited Warranty

Andersen offers quick, easy warranty registration on our website. Just go to www.andersenwindows.com/warranty and submit your warranty information online. By registering, you will expedite any warranty service you may have in the future. In addition, you can receive product information updates, safety notices and special offers regarding new products, as well as information regarding enhancements for the windows and doors you've registered.

All warranty information is treated confidentially and will not be sold or traded to any person or organization outside of Andersen and the Andersen Dealer Network.

**EASY Online
Registration**

Warranty Claim Procedure

To make a claim under this Limited Warranty, contact the Andersen retailer/dealer who sold you your Andersen® product. Or, you may contact us at:

Andersen Windows, Inc./Andersen Service Center
100 Fourth Avenue North
Bayport, MN 55003-1096

You may also contact us using the Parts & Service section of our website at www.andersenwindows.com or reach us by phone at 1-888-888-7020.

You can help us serve you faster by providing the following important information:

- Description of the product such as the exterior color, unit type and size and inside visible glass measurements.
- Glass logo information etched in the inside corner of the glass.
- Description of product concerns.
- Documentation of the purchase date, if available.
- Your name, address (with zip code) where the product is installed and telephone numbers.

Non-Warranty Repair

You will be responsible for all costs related to any repair that is not covered by this Limited Warranty or which is outside of the limited warranty period. When warranty coverage is unclear, Andersen may charge an inspection fee for any on-site product inspection. If the inspector determines the Andersen® product has a defect covered by this Limited Warranty, the inspection fee will be waived.

For specific warranty information outside the United States, please contact your local distributor or write to:

Andersen Windows, Inc. / International Division
100 Fourth Avenue North
Bayport, MN 55003-1096

DISPUTE RESOLUTION PROCESS

General

If you are dissatisfied with the remedy provided to you under the Limited Warranty set forth above or have any other claim against Andersen related to your Andersen products, you and Andersen agree to resolve the claim using the following process ("Dispute Resolution Process"). This Dispute Resolution Process will apply to claims of any nature relating to your Andersen product ("Dispute(s)"). Disputes include, but are not limited to, claims for breach of contract or breach of warranty, claims for violation of state or federal laws or regulations, claims based in tort, negligence or product liability, claims based in fraud or fraud in the inducement, marketing or advertising claims and claims related to the enforceability or effect of any term of the Limited Warranty or the Dispute Resolution Process, including, but not limited to, the waivers of class action and jury trials.

Notice Required

To assert a Dispute, you must first provide Andersen with written notice. A Notice of Dispute form is available for your use on Andersen's website at www.andersenwindows.com/noticeofdispute.

Andersen Response

Andersen will have 60 days from receipt of your Notice of Dispute to respond to you in writing. In that response or at any later time, Andersen may make one or more written offers to you to resolve your Dispute.

No Class Action or Jury Trials

YOU AGREE THAT YOU MAY ASSERT DISPUTES AGAINST ANDERSEN ONLY ON AN INDIVIDUAL BASIS AND NOT AS A PLAINTIFF OR CLASS MEMBER IN ANY CLASS OR REPRESENTATIVE ACTION OR PROCEEDING. AS PART OF THIS DISPUTE RESOLUTION PROCESS, YOU AND ANDERSEN ALSO AGREE TO WAIVE ANY RIGHT TO A JURY AND AGREE TO HAVE ALL DISPUTES HEARD AND DECIDED SOLELY BY THE FEDERAL OR STATE COURT JUDGE.

Opt-Out Procedure

You may opt out of this Dispute Resolution Process by completing and submitting a written Opt-Out Notice. The Opt-Out Notice is located on Andersen's website at www.andersenwindows.com/optout. Whether or not you opt out of the Dispute Resolution Process, all terms of the Limited Warranty set forth above remain in force and effect.

Applicable Law and Severability

This Dispute Resolution Process, including, but not limited to, issues related to its enforceability and effect, will be governed by the laws of the State of Minnesota without regard to conflict of law principles. If any term of this Dispute Resolution Process is found to be invalid or unenforceable in any particular jurisdiction, that term will not apply to that issue in that jurisdiction. Instead, that term will be severed with the remaining terms continuing in full force and effect.

Questions

If you have questions about the Dispute Resolution Process or Opt-Out Procedure, contact us at 844-332-7972.



IMPROVING THE VIEW OUTSIDE THE ENVIRONMENT HAS A BUSINESS PARTNER

Respect for the environment is nothing new at Andersen. For more than a century, it's been part of who we are. Our commitment to recycle and reclaim materials began simply because it was good business. Now it's part of our commitment to sustainability and responsible stewardship of all our resources. Andersen is committed to providing you with long-lasting,* energy-efficient windows and doors.

Visit andersencorporation.com or andersenwindows.com/sustainability for more information.



Andersen® products are certified under the National Fenestration Rating Council's voluntary third-party certification program designed to ensure accurate energy performance ratings and labeling.



The Window & Door Manufacturers Association (WDMA) Hallmark Certification program includes product testing and quality-control process audits to verify that Andersen® windows and doors are produced in conformance with the industry standards for air, water resistance and structural performance.

Celebrating
115 Years
1903-2018

Andersen® WINDOWS • DOORS



10% POST CONSUMER RECYCLED FIBER

Printed on FSC® certified paper, with a minimum of 10% post-consumer recovered fiber. The cover paper is produced using Green-e certified renewable energy.

*Visit andersenwindows.com/warranty for details. All trademarks where denoted are marks of their respective owners. ©2018 Andersen Corporation. All rights reserved. 05/18 Part #9167986