

What's in This Section

Circle & Oval Windows	Page 3
Parts Illustration	3
Unit Sizes	4
400 Series Product Label	4
Unit Size Chart	4
Product History	5
Product History	5
Glass	6
Glass Size Table	6
Glass	7
Grilles	8
Interior Grilles - Curved Windows Patterns	8
Interior Grilles - 3/4"	9
Interior Grilles - 7/8"	10
Interior Grille Parts	10
Frames	11
Frame Assembly - Circle & Oval	11
Frame Assembly - Monumental Circle & Monumental Quarter Circle	11
Stops	12
Transition Blocks	13
Optional Components	14
Inside Casing	14
Key Block	16
Extension Jambs	17
Drywall Return Bead	19
Art Glass Components	20
Art Glass	20
Art Glass Stops	20
Art Glass Hardware	21
Stormwatch™ Protection (Coastal Product)	Page 23
Glass (Impact Resistant)	23
Glass	23
Frames (Impact Resistant)	25
Stops	25
Transition Blocks	25

Inside Casing 26
Extension Jambs 26
Jamb Clip Kit 27
Installation Clips 27

Service Replacement Page 29

Service Replacement Only Parts 29
Service Replacement Only Parts 29

Parts Illustration

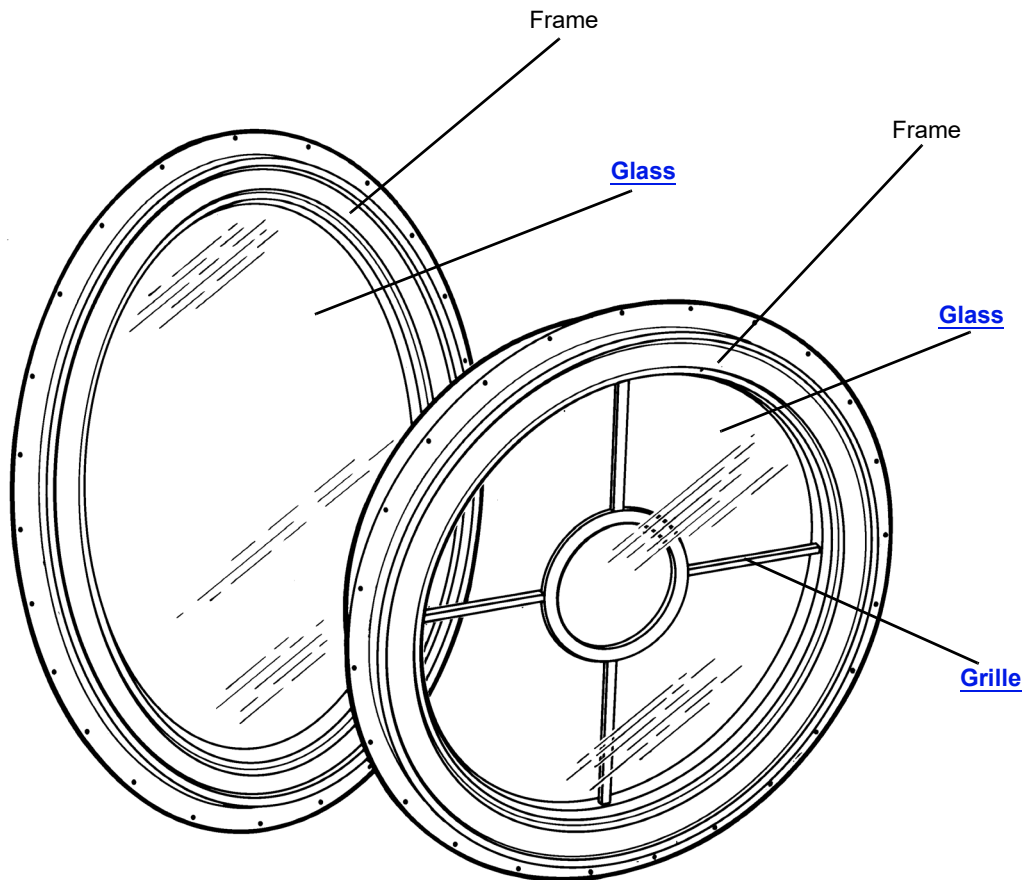

Manufactured 1991 to Present

Circle & Oval Unit Parts

Unit Sizes

400 Series Product Label

Note:

Some Circle/Oval Windows will have an identification label or glass etching containing a unique Product ID. The Product ID on Circle/Oval Windows will be located at the top of the window frame or etched into the glass. See [Service Guide 9051877](#). The Product ID may be up to 14 digits long (excluding hyphens), depending on the age of the unit. Replacement parts will also get their own unique Product ID. When ordering replacement parts, providing the Product ID ensures that replacement parts match the specifications.

Unit Size Chart

Note:

Unit Dimension refers to overall outside-to-outside frame. Unobstructed Glass refers to visible glass dimensions. Numbers in parentheses are metric measurements.

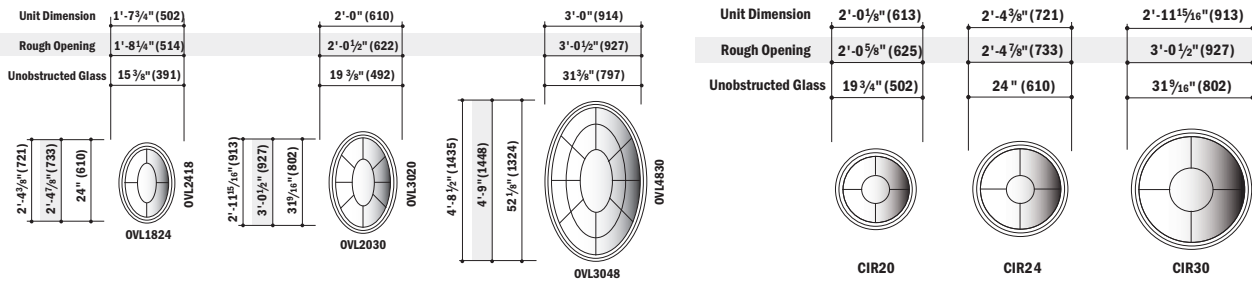

Unit Dimension	2'-0 ¹ / ₈ " (613)	2'-4 ³ / ₈ " (721)	2'-11 ¹⁵ / ₁₆ " (913)	4'-0" (1219)
Minimum Rough Opening	2'-0 ⁵ / ₈ " (625)	2'-4 ⁷ / ₈ " (733)	3'-0 ¹ / ₂ " (927)	4'-0 ¹ / ₂ " (1232)
Unobstructed Glass	19 ⁷ / ₁₆ " (495)	23 ¹¹ / ₁₆ " (602)	31 ¹ / ₄ " (794)	43 ⁵ / ₁₆ " (110)
Radius	32 ¹ / ₄ " (819)	32 ¹ / ₄ " (819)	36" (914)	48" (1219)

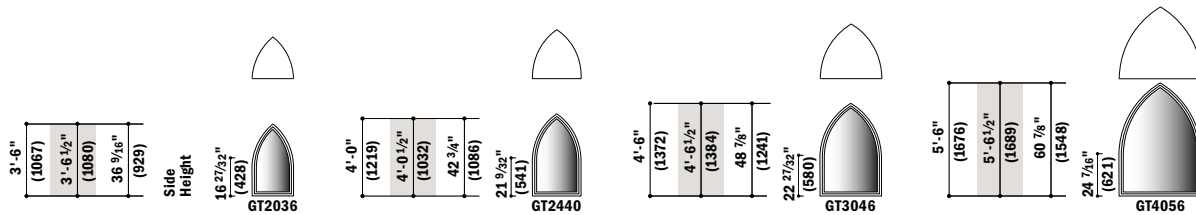

Unit Dimension	2'-0" (610)	2'-4" (711)	3'-0" (914)	Unit Dimension	4'-0" (1219)	4'-0" (1219)	6'-0" (1829)
Minimum Rough Opening	2'-0 ¹ / ₂ " (622)	2'-4 ¹ / ₂ " (724)	3'-0 ¹ / ₂ " (927)	Minimum Rough Opening	4'-0 ¹ / ₂ " (1232)	4'-0 ¹ / ₂ " (1232)	6'-0 ¹ / ₂ " (1842)
Unobstructed Glass	19 ⁵ / ₁₆ " (491)	23 ⁵ / ₁₆ " (592)	31 ⁵ / ₁₆ " (795)	Unobstructed Glass	43 ¹ / ₄ " (1099)	43 ⁵ / ₁₆ " (1100)	67 ⁵ / ₁₆ " (1710)
	OC20	OC24	OC30	Radius	48" (1219)	24" (610)	36" (914)



400 Series Circle & Oval Windows (1991 to Present)

Circle & Oval Windows

Product History

Product History

- | | |
|-------------|---|
| 2024 | Select tilt-wash, casement, and complementary products with triple-pane glass in Connecticut, Massachusetts, Maine, New Hampshire, New Jersey, New York, Rhode Island, Vermont, and Pennsylvania on October 21, 2024. |
| 2003 | Stormwatch™ Protection (Coastal Product) with design pressure upgrades, glass options, and structural enhancements introduced for Elliptical & Circle Top Windows and Circle & Oval windows. |
| 1991 | Circle/Oval Windows introduced. |

Glass

Glass Size Table		
Unit No.	Unobstructed Glass (w x h)	Actual Glass (w x h)
CIR20	19 ³ / ₄	20 ⁷ / ₈
CIR24	24	25 ¹ / ₈
CIR30	31 ⁹ / ₁₆	32 ¹¹ / ₁₆
OVL1824	15 ³ / ₈ × 24	16 ¹ / ₂ × 25 ¹ / ₈
OVL2418	24 × 15 ³ / ₈	25 ¹ / ₈ × 16 ¹ / ₂
OVL2030	19 ³ / ₈ × 31 ⁹ / ₁₆	20 ³ / ₄ × 32 ¹¹ / ₁₆
OVL3020	31 ⁹ / ₁₆ × 19 ³ / ₈	32 ¹¹ / ₁₆ × 20 ³ / ₄
OVL3048	31 ³ / ₈ × 52 ¹ / ₈	32 ³ / ₄ × 53 ¹ / ₄
OVL4830	52 ¹ / ₈ × 31 ³ / ₈	53 ¹ / ₄ × 32 ³ / ₄

400 Series Circle & Oval Windows (1991 to Present)

Circle & Oval Windows

Glass

Glass Logo

Low-E



Low-E SmartSun™



Low-E HeatLock™



Low-E SmartSun™ HeatLock™



Tempered Logo

TEMPERED UA
16 CFR 1201.11
ANSI Z97.1-2009
SGCC XXXX
CIG-XX Xmm MM/DD/YR
CAN/CGSB 12.1-M90

Note:

Stationary units - order a replacement glass for units.
See sash [Product Details](#), [Service Guide 0004175](#).

Exterior color options: White, Sandtone, Terratone, Forest Green, Canvas, Dark Bronze and Black.

Interior finish options: Pine, White, Dark Bronze, Black

Glass options: (See Logo example): Primary glazing options. Glazings also available in an STC upgrade package. If tempered, logo can be located in any corner other than the AW logo location.

Low-E	Low-E Tempered	Low-E Obscure	Low-E Tempered Obscure
Low-E SmartSun™	Low-E SmartSun™ HeatLock	Low-E SmartSun™ Obscure	Low-E SmartSun™ Tempered Obscure
Low-E HeatLock	Low-E HeatLock Tempered	Low-E SmartSun™ HeatLock Tempered	Dual Pane Insulated
Low-E Passive Sun HeatLock	Triple Pane Glass - 7 enhanced options		

Grille types: Five (5) primary grille types

Finelight™ Grilles-Between-the-Glass	Finelight™ Grilles-Between-the-Glass w/Exterior Grilles	Full Divided Light (FDL)	Full Divided Light (FDL) w/ Energy Spacer*	Simulated Divided Light (SDL)

Grille patterns: Seven (7) primary grille patterns



To order, state:

1. Description of part (GLASS)
2. Product ID (from product label, see [Service Guide 9051877](#).)
3. Manufacturing date

Glass

Glass

Note:

Stops must be ordered separately.

Glass - Circle and Oval Window / High-Performance Low-E4®

	Unit No.	Order No.
	CIR 20	1075002
	CIR 24	1075004
	CIR 30	1075006
	OVL 1824/2418	1075022
	OVL 2030/3020	1075024
	OVL 3048/4830	1075026

Glass - Circle and Oval Window / High-Performance Low-E4® Sun 3

	Unit No.	Order No.
	CIR 20	By description
	CIR 24	By description
	CIR 30	By description
	OVL 1824/2418	1075122
	OVL 2030/3020	1075124
	OVL 3048/4830	1075126

Glass - Circle and Oval Window / High-Performance Sun II

Note:

High Performance Sun II glass is available by description.

Glass - Circle and Oval Window / High-Performance Low-E4® Finelight™

	Unit No.	Order No.
	CIR 20	1070132
	CIR 24	1070134
	CIR 30	1070136
	OVL 1824/2418	By description
	OVL 2030/3020	By description
	OVL 3048/4830	By description

400 Series Circle & Oval Windows (1991 to Present)

Circle & Oval Windows

Grilles

Interior Grilles - Curved Windows Patterns

Note:

Grilles include fasteners. See [IQ+](#) for inclusive availability of grille options.

See [Accessory Guide 0005285](#). See [Accessory Guide 0004342](#). See [Accessory Guide 0004346](#).

Standard Divided Light Patterns for Circle and Oval Windows

Colonial

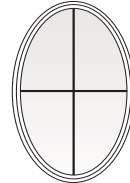

Renaissance

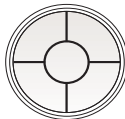

CIR20*

CIR24*

CIR30*

OVL1824*

OVL2030*

OVL3048*

* Not available in 1-1/8" profile for these sizes.

Grilles

Interior Grilles - 3/4"							
Interior Grille - Circle, & Oval Window / Renaissance / 3/4" Wood / Natural Wood Interior							
Unit No.	Exterior						
	White	Terratone	Sandtone	Forest Green	Canvas	Dark Bronze	Black
	Maple Interior						
							
CIR 20	1071002	1071202	1071402	1071830	9053145	9072584	9127763
CIR 24	1071004	1071204	1071404	1071831	9053146	9072585	9127764
CIR 30	1071006	1071206	1071406	1071832	9053147	9072586	9127765
OVL 1824/2418	1071022	1071222	1071422	1071833	9053148	9072587	9127766
OVL 2030/3020	1071024	1071224	1071424	1071834	9053149	9072588	9127767
OVL 3048/4830	1071026	1071226	1071426	1071835	9053150	9072589	9127768

Interior Grille - Circle & Oval Window / Renaissance / 3/4" Wood / Prefinished Interior							
Unit No.	Exterior						
	White	Terratone	Sandtone	Forest Green	Canvas	Dark Bronze	Black
	Interior						
	White	Terratone	Sandtone	Forest Green	Canvas	Dark Bronze	Black
CIR 20	1071102	1071302	1071502	By description	9053151	9072590	9127769
CIR 24	1071104	1071304	1071504	By description	9053152	9072591	9127770
CIR 30	1071106	1071306	1071506	By description	9053153	9072592	9127771
OVL 1824/2418	1071122	1071322	1071522	By description	9053154	9072593	9127772
OVL 2030/3020	1071124	1071324	1071524	By description	9053155	9072594	9127773
OVL 3048/4830	1071126	1071326	1071526	By description	9053156	9072595	9127774

Interior Grille - Circle & Oval Window / Colonial / 3/4" Wood / Natural Wood Interior							
Note: Colonial grilles are order by description.							

Interior Grille - Circle & Oval Window / Colonial / 3/4" Wood / Prefinished Interior							
Note: Colonial grilles are order by description.							

400 Series Circle & Oval Windows (1991 to Present)

Circle & Oval Windows

Grilles

Interior Grilles - 7/8"							
Interior Grille - Circle, & Oval Window / Renaissance / 7/8" Wood / Natural Wood Interior							
Unit No.	Exterior						
	White	Terratone	Sandtone	Forest Green	Canvas	Dark Bronze	Black
	Maple Interior						
	<div style="background-color: #d2b48c; padding: 5px; display: inline-block; border: 1px solid black;"> MAPLE </div>						
FR40	2261172	2261191	2261211	2267115			
FR60	2261173	2261192	2261212	2267116			

Interior Grille - Circle & Oval Window / Renaissance / 7/8" Wood / Prefinished Interior							
Unit No.	Exterior						
	White	Terratone	Sandtone	Forest Green	Canvas	Dark Bronze	Black
	Interior						
	White	Terratone	Sandtone	Forest Green	Canvas	Dark Bronze	Black
FR40	2261115	2261134	2261153				
FR60	2261116	2261135	2261154				

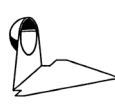
Interior Grille Parts		
Interior Grille Fastener - Wood / Non-Standard		
		Order No. 1974312

Frames

Frame Assembly - Circle & Oval

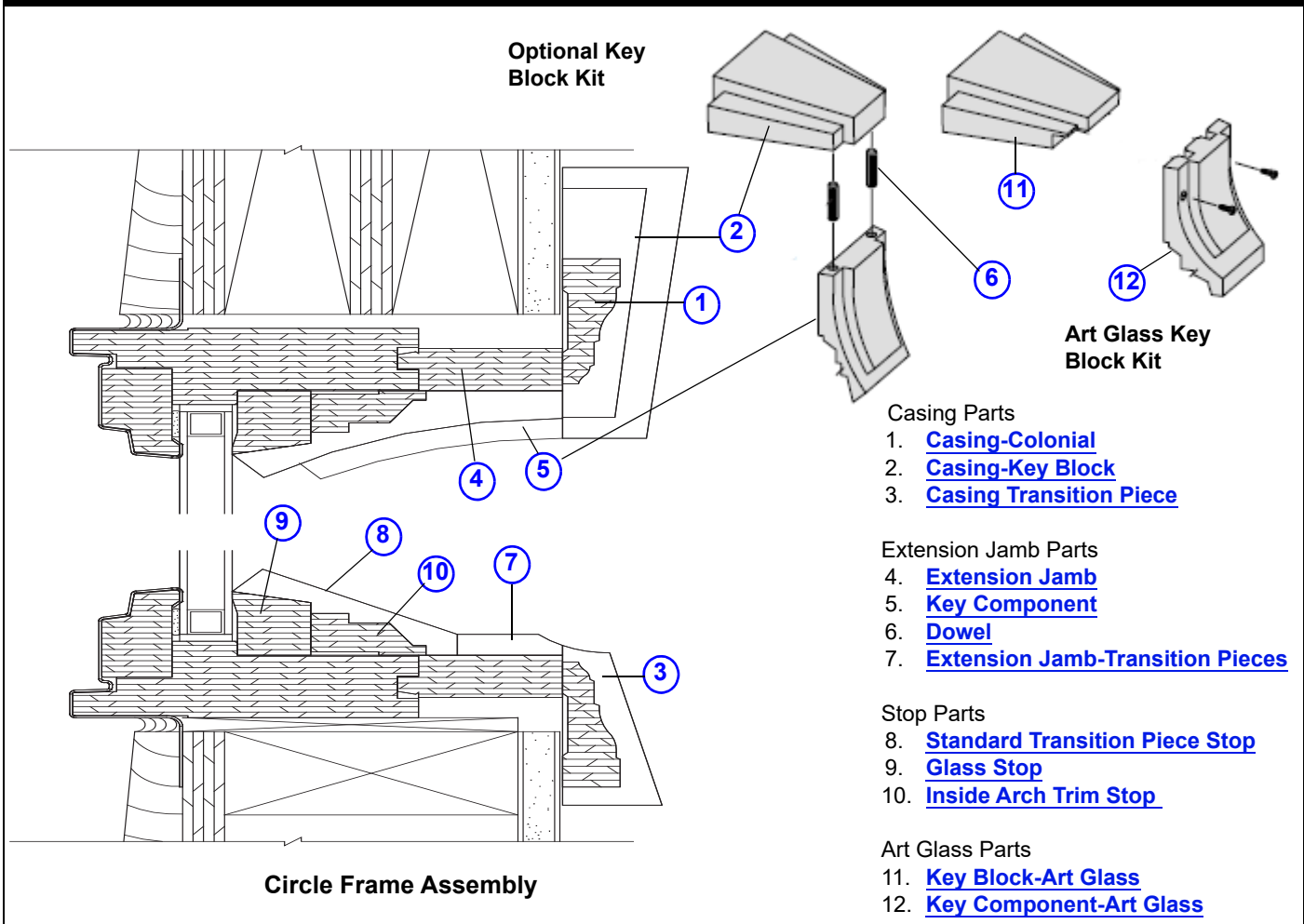

Frame Assembly - Monumental Circle & Monumental Quarter Circle

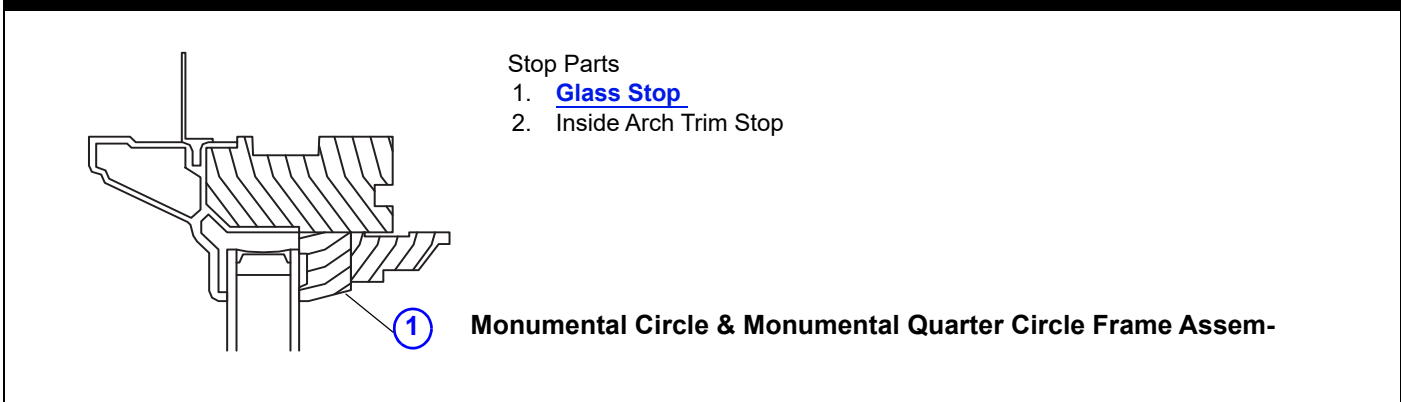

400 Series Circle & Oval Windows (1991 to Present)

Circle & Oval Windows

Frames

Stops

Note:

Order a quantity of two stops for a unit.

Trim Stop - Circle & Oval Arch / Inside No. 10 [page 12](#)

Unit No.	Maple	White	Dark Bronze	Black
CIR 20	1076514	9013890	9209119	9208940
CIR 24	1076516	9013893	9209122	9208943
CIR 30	1076518	9013896	9209122	9208946
OVL 1824/2418	1076520	9013952	9209169	9208990
OVL 2030/3020	1076522	9013955	9209172	9208993
OVL 3048/4830	1076524	9013958	9209175	9208996

Glass Stop - Circle & Oval Arch / Inside No. 9 [page 12](#)

Unit No.	Maple	White	Dark Bronze	Black
CIR 20	1076534	9013891	92091520	6208941
CIR 24	1076536	9013894	92091523	6208944
CIR 30	1076538	9013897	92091526	6208947
OVL 1824/2418	1076540	9013953	9209169	9208990
OVL 2030/3020	1076542	9013956	9209172	9208993
OVL 3048/4830	1076544	9013959	9209175	9208996

Glass Stop - Monumental Circle & Monumental Quarter Circle Arch / Inside No. 1 [page 12](#)

Unit No.	Maple	White	Dark Bronze	Black
54/60	6033012	6033002	9209118	9208939
54	2283050	2282950	-	-
60	2283051	2282951	-	-

Frames

Transition Blocks

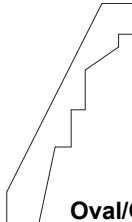
 <p>Oval/Circle</p>	<p>Note: Circle transition blocks are cut at a 45 degree angle. Used on standard and HPIR units. Units with laminated glass use a unique transition block page 25 Units with art glass use a unique transition block page 22 See Accessory Guide 0005235. Modifications may be needed when interior grilles are positioned where the transition piece meets grille.</p>
---	--

Transition Block - Inside Stop / Narrow (Pair) No. 8 [page 12](#)

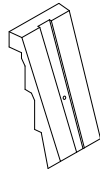
 <p>Narrow</p>	<p>Note: Transition block is 1.027" wide.</p>	Unit No.	Color/Species	Order No.
		OVL/CIR	Pine	9118983
			Maple	1076607
			Oak	9116880
			White	9069001
			Dark Bronze	9183827
			Black	9183813

Transition Block - Inside Stop / Wide (Pair)

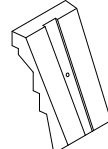
 <p>Wide</p>	<p>Note: Transition block is 1.618" wide. Wider transition pieces are just an aesthetic choice for customers who like the wider profile, or they want to match the wider interior grille profiles.</p>	Unit No.	Color/Species	Order No.
		OVL/CIR	Pine	9118977
			Maple	1076638
			Oak	9116882
			White	9069005
			Dark Bronze	9183829
			Black	9183815

400 Series Circle & Oval Windows (1991 to Present)

Circle & Oval Windows

Optional Components

Inside Casing

Note:

See **iQ+** for inclusive availability of casing options. See [Accessory Guide 0004338](#).

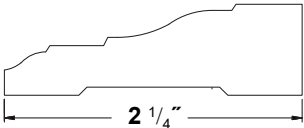
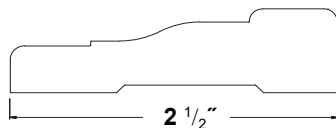
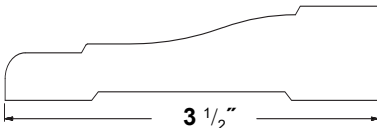
Inside Casing - Arch / Colonial Ref. No. 1 page 12									
Unit No.	2 1/4			2 1/2			3 1/2		
									
	WM366			WM351			WM444		
	Pine	Maple	Oak	Pine	Maple	Oak	Pine	Maple	Oak
CIR 20	9074368	1075226	1075238	9074362	1075202	N/A	9074374	1075274	1075290
CIR 24	9074369	1075228	1075240	9074363	1075204	N/A	9074375	1075276	1075292
CIR 30	9074370	1075230	1075242	9074364	1075206	N/A	9074376	1075278	1075294
OVL 1824/2418	9074371	1075232	1075244	9074365	1075208	N/A	9074377	1075282	1075298
OVL 2030/3020	9074372	1075234	1075246	9074366	1075210	N/A	9074378	1075284	1075301
OVL 3048/4830	9074373	1075236	1075248	9074367	1075212	N/A	9074379	1075286	1075302

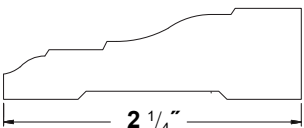
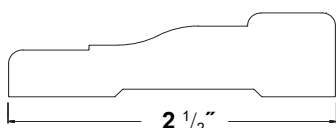
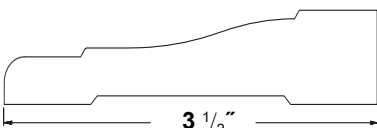
Inside Casing - Arch / Colonial with Narrow Transition Block									
Unit No.	2 1/4			2 1/2			3 1/2		
									
	WM366			WM351			WM444		
	Pine	Maple	Oak	Pine	Maple	Oak	Pine	Maple	Oak
CIR 20	9078225	1073402	1073502	9078219	1073002	N/A	9078231	1073802	1073902
CIR 24	9078226	1073404	1073504	9078220	1073004	N/A	9078232	1073804	1073904
CIR 30	9078227	1073406	1073506	9078221	1073006	N/A	9078233	1073806	1073906
OVL 1824/2418	9074256	1073422	1073522	9074252	1073022	N/A	9074260	1073822	1073922
OVL 2030/3020	9074266	1073424	1073524	9074262	1073024	N/A	9074270	1073824	1073924
OVL 3048/4830	9074276	1073426	1073526	9074272	1073026	N/A	9074280	1073826	1073926

Optional Components

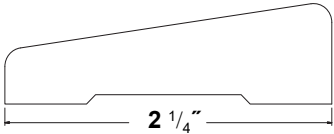
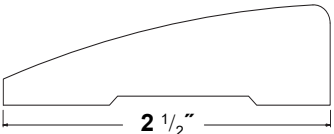
Inside Casing - Arch / Ranch						
Unit No.	$2 \frac{1}{4}$			$2 \frac{1}{2}$		
						
	WM324			WM315		
	Pine	Maple	Oak	Pine	Maple	Oak
CIR 20	9074386	1075250	1075262	9074380	1075214	N/A
CIR 24	9074387	1075252	1075264	9074381	1075216	N/A
CIR 30	9074388	1075254	1075266	9074382	1075218	N/A
OVL 1824/2418	9074389	1075256	1075268	9074383	1075220	N/A
OVL 2030/3020	9074390	1075258	1075270	9074384	1075222	N/A
OVL 3048/4830	9074391	1075260	1075272	9074385	1075224	N/A

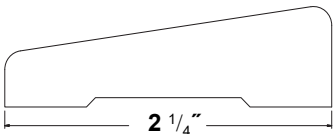
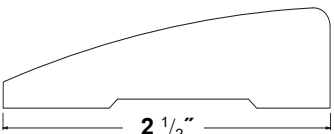
Inside Casing - Arch / Ranch with Narrow Transition Block						
Unit No.	$2 \frac{1}{4}$			$2 \frac{1}{2}$		
						
	WM324			WM315		
	Pine	Maple	Oak	Pine	Maple	Oak
CIR 20	9078228	1073602	1073702	9078222	1073202	N/A
CIR 24	9078229	1073604	1073704	9078223	1073204	N/A
CIR 30	9078230	1073606	1073706	9078224	1073206	N/A
OVL 1824/2418	9074258	1073622	1073722	9074254	1073222	N/A
OVL 2030/3020	9074268	1073624	1073724	9074264	1073224	N/A
OVL 3048/4830	9074278	1073626	1073726	9074274	1073226	N/A

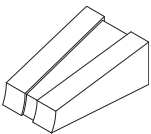
Transition Casing Block (Pair) Ref. No. 3 page 12							
	Unit No.	$2 \frac{1}{4}$ " and $2 \frac{1}{2}$ "			$3 \frac{1}{2}$ "		
		Pine	Maple	Oak	Pine	Maple	Oak
	CIR/OVL		9074402	1076610	1076612	9074403	1076616

400 Series Circle & Oval Windows (1991 to Present)

Circle & Oval Windows

Optional Components

Key Block

Note:

See [Accessory Guide 0004337](#).

Key Block Kit Ref. No. 2 & 5 [page 12](#)

Kit Includes: (2) Optional Key Blocks (2) Key Components (4) Dowels	4 ⁹ / ₁₆ " Wall			5 ¹ / ₄ " Wall		
	Maple	Oak	Pine	Maple	Oak	Pine
	CIR	1072002	1072202	9074392	1072004	1072204
OVL	1072022	1072222	9074396	1072024	1072224	9074397
	6 ⁹ / ₁₆ " Wall			7 ¹ / ₈ " Wall		
	Maple	Oak	Pine	Maple	Oak	Pine
	CIR	1072006	1072206	9074394	1072008	1072208
OVL	1072026	1072226	9074398	1072028	1072228	9074399

Key Block Ref. No. 2 [page 12](#)

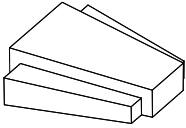
	Unit No.	Maple	Oak	Pine
	CIR/OVL		2231114	2231115

Optional Components

Extension Jamb

Extension Jamb Kit - Arch with Narrow Transition Blocks Ref. No. 4 [page 12](#)

Note:

Some units require a combination of curved and straight extension jambs and individual transition components.

Unit No.	Shape	White				Natural Wood Interior			
		4 9/16" Wall	5 1/4" Wall	6 9/16" Wall	7 1/8" Wall	4 9/16" Wall	5 1/4" Wall	6 9/16" Wall	7 1/8" Wall
CIR 20		1074830	1074836	1074842	1074848	1074502	1074602	1074702	1074802
CIR 24		1074831	1074837	1074843	1074849	1074504	1074604	1074704	1074804
CIR 30		1074832	1074838	1074844	1074850	1074506	1074606	1074706	1074806
FR40		See 400 Series Springline				See 400 Series Springline			
FR60		See 400 Series Springline				See 400 Series Springline			
QR40		See 400 Series Springline				See 400 Series Springline			
GT2036		See 400 Series Springline				See 400 Series Springline			
GT2440		See 400 Series Springline				See 400 Series Springline			
GT3046		See 400 Series Springline				See 400 Series Springline			
GT4056		See 400 Series Springline				See 400 Series Springline			
OVL 1824/2418		1074833	1074839	1074845	1074851	1074522	1074622	1074722	1074822
OVL 2030/3020		1074834	1074840	1074846	1074852	1074524	1074624	1074724	1074824
OVL 3048/4830		1074835	1074841	1074847	1074853	1074526	1074626	1074726	1074826

Extension Jamb Kit - Arch with Wide Transition Blocks

Unit No.	Shape	Natural Wood Interior			
		4 9/16" Wall	5 1/4" Wall	6 9/16" Wall	7 1/8" Wall
CIR 20		1074901	1074907	1074913	1074919
CIR 24		1074902	1074908	1074914	1074920
CIR 30		1074903	1074909	1074915	1074921
FR40		See 400 Series Springline			
FR60		See 400 Series Springline			
QR40		See 400 Series Springline			
GT2036		See 400 Series Springline			
GT2440		See 400 Series Springline			
GT3046		See 400 Series Springline			
GT4056		See 400 Series Springline			
OVL 1824/2418		1074904	1074910	1074916	1074922
OVL 2030/3020		1074905	1074911	1074917	1074923
OVL 3048/4830		1074906	1074912	1074918	1074924

400 Series Circle & Oval Windows (1991 to Present)

Circle & Oval Windows

Optional Components

Transition Block - Narrow (Pair) No. 7 [page 12](#)

Note:

See [Accessory Guide 0004336](#).

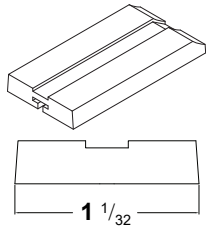
	Color	4 9/16" Wall	5 1/4" Wall	6 9/16" Wall	7 1/8" Wall
	Maple	1076618	1076622	1076626	1076630
	Oak	9116904	9116895	9116906	9116896
	Pine	9118975	9118972	9118976	9118974
	White	9024278	9071656	9024279	9071657
	Dark Bronze	9183824	9183834	9183825	9183835
	Black	9183810	9183820	9183811	9183821

Transition Block - Wide (Pair)

Note:

See [Accessory Guide 0004336](#).

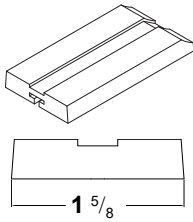
	Color	4 9/16" Wall	5 1/4" Wall	6 9/16" Wall	7 1/8" Wall
	Maple	1074949	1074950	1074951	1074952
	Oak	9116891	9116892	9116893	9116894
	Pine	6051025	9118971	6051026	9118973
	White	9071652	9071653	9071654	9071655
	Dark Bronze	9183830	9183831	9183832	9183833
	Black	9183816	9183817	9183818	9183819

Transition Block Fastener - Extension Jamb

	Unit No.	4 9/16" Wall	5 1/4" Wall	6 9/16" Wall	7 1/8" & 7 9/16" Wall
	CIR/OVL	1076620	1076624	1076628	1076632

Key Component Ref. No. 5 [page 12](#)

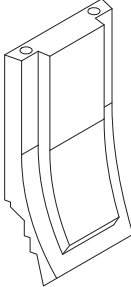
	Product Line	Pine			
		4 9/16" Wall	5 1/4" Wall	6 9/16" Wall	7 1/8" Wall
	CIR	9074405	9074406	9074407	9074408
	OVL	9074409	9074410	9074411	9074412
	Product Line	Oak			
		4 9/16" Wall	5 1/4" Wall	6 9/16" Wall	7 1/8" Wall
	CIR	1076714	1076716	1076718	1076720
	OVL	1076732	1076734	1076736	1076738
	Product Line	Maple			
		4 9/16" Wall	5 1/4" Wall	6 9/16" Wall	7 1/8" Wall
	CIR	1076706	1076708	1076710	1076712
	OVL	1076722	1076724	1076726	1076728

Key Component Dowels Ref. No. 6 [page 12](#)

Unit No.	Order No.
All Units	8231901

Optional Components



Drywall Return Bead

Drywall Return Bead Circle - Curved (Wide)

Note:

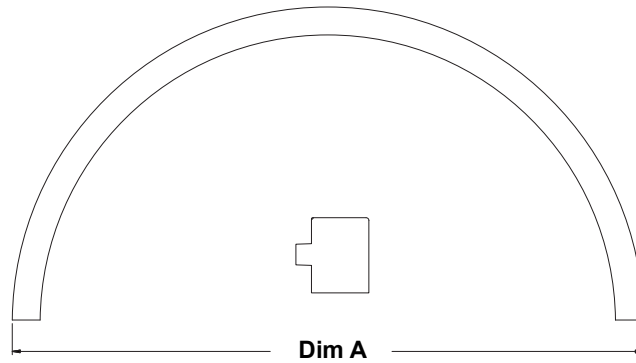
Two pieces used for circle units.





Unit No.	Length (Dim A)	White 	Pine 
CIR20	21 ²⁷ / ₃₂	9118960	9118957
CIR24	26 ³ / ₃₂	9118961	9118958
CIR30	29 ⁷ / ₃₂	9118962	9118959

Drywall Return Bead Oval - Curved (Wide)

Note:

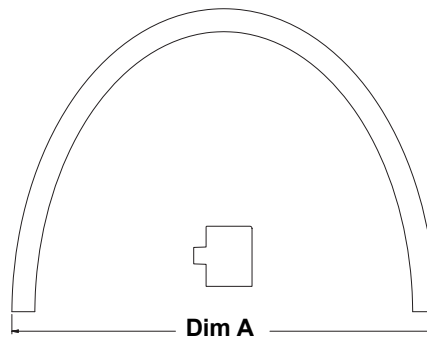
Two pieces used for oval units.



Unit No.	Length (Dim A)	White 	Pine 
OVAL1824	19 ¹⁹ / ₃₂	9118966	9118963
OVAL2030	23 ²⁷ / ₃₂	9118967	9118964
OVAL3048	35 ²⁷ / ₃₂	9118968	9118965

400 Series Circle & Oval Windows (1991 to Present)

Circle & Oval Windows

Art Glass Components

Art Glass

Note:

Information about ordering replacement art glass panels can be found in the Andersen® Art Glass™ section of the catalog.

Art Glass Stops

Trim Stop - Circle Window / Arch / Inside

Note:

Quantity of one.

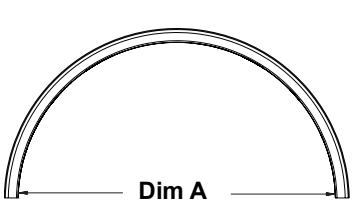
	Unit No.			Dim A		Order No.	
	AG CIR20			18 ¹¹ / ₁₆		2370230	
	AG CIR24			22 ¹⁵ / ₁₆		2370232	
	AG CIR30			30 ¹ / ₂		2370234	

Trim Stop - Oval Window / Arch / Inside

Note:

Quantity of one.

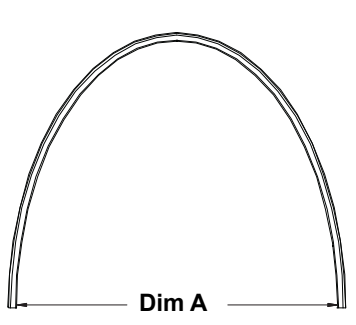
	Unit No.			Dim A		Order No.	
	AG OVL1824			14 ⁵ / ₁₆		2370236	
	AG OVL2030			18 ¹ / ₂		2370238	
	AG OVL3048			30 ¹ / ₂		2370240	

Key Block Kit Ref. No. 11 & 12 [page 12](#)

Kit Includes: (2) Art Glass Key Blocks (2) Art Glass Key Components (4) #5 x 1" Screws (2) Fasteners	4 ⁹/₁₆" Wall			5 ¹/₄" Wall		
	Maple	Oak	Pine	Maple	Oak	Pine
	2370011	2370015	9074423	2370012	2370016	9074424
	6 ⁹/₁₆" Wall			7 ¹/₈" Wall		
	Maple	Oak	Pine	Maple	Oak	Pine
	2370013	2370017	9074425	2370014	2370018	9074426

Key Block Component Ref. No. 12 [page 12](#)

	4 ⁹/₁₆" Wall			5 ¹/₄" Wall		
	Maple	Oak	Pine	Maple	Oak	Pine
	2370003	2370007	9074419	2370004	2370008	9074420
	6 ⁹/₁₆" Wall			7 ¹/₈" Wall		
	Maple	Oak	Pine	Maple	Oak	Pine
	2370005	2370009	9074421	2370006	2370010	9074422

Art Glass Components

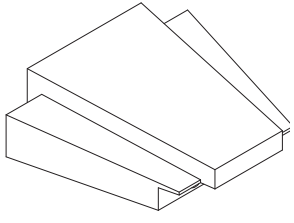
Key Block / Art Glass					
		Unit No.	Maple	Oak	Pine
			CIR/OVL	1076704	1076702

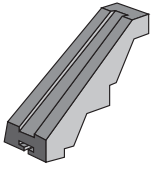
Transition Block Stop		
	Note: Units without art glass and with laminated glass use a unique transition block on page 25 All other units without art glass use transition block on page 14	Order No.
		2370002

Art Glass Hardware		
Bracket Package - Top and Bottom		
	Note: Includes shims and screws.	Order No.
		2370020
Bracket - Top Only		
	Note: Includes screws.	Order No.
		2370024
Screw Head Package		
	Description	Order No.
	Brass / Oval / AG 1x5 STD	2370026

400 Series Circle & Oval Windows (1991 to Present)

Stormwatch™ Protection (Coastal Product)

Andersen® products with Stormwatch protection are designed for use in coastal areas. They feature design pressure upgrades, glass options, and structural enhancements.

Glass (Impact Resistant)

Glass (<i>Impact Resistant</i>)		
Note: Stops must be ordered separately.		
Glass - Circle and Oval Window / High-Performance Low-E4® Impact Resistant		
	Unit No.	Order No.
	CIR 20	By description
	CIR 24	By description
	CIR 30	By description
	OVL 1824/2418	1070143
	OVL 2030/3020	1070144
	OVL 3048/4830	1070145

Glass - Circle and Oval Window / High-Performance Low-E4® Sun 3 Impact Resistant		
	Unit No.	Order No.
	CIR 20	By description
	CIR 24	By description
	CIR 30	By description
	OVL 1824/2418	1070161
	OVL 2030/3020	1070162
	OVL 3048/4830	1070163

Glass - Circle and Oval Window / High-Performance Sun II Impact Resistant		
Note: Impact resistant High-Performance Sun II glass is available by description.		

Glass - Circle and Oval Window / High-Performance Low-E4® Tempered Impact Resistant		
	Unit No.	Order No.
	CIR 20	By description
	CIR 24	By description
	CIR 30	By description
	OVL 1824/2418	1070149
	OVL 2030/3020	1070150
	OVL 3048/4830	1070151

Glass (Impact Resistant)

Glass - Circle and Oval Window / High-Performance Low-E4® Sun 3 (I know these were once called sun 3, but now probably chase the description that appears to show 2..... Oh, the fun game of chasing what these sun glazings are called.....you get what we send you) Tempered Impact Resistant

	Unit No.	Order No.
	CIR 20	By description
	CIR 24	By description
	CIR 30	By description
	OVL 1824/2418	1070155
	OVL 2030/3020	1070156
	OVL 3048/4830	1070157

Glass - Circle and Oval Window / High-Performance Sun II Tempered (Impact Resistant)

Note:
Impact resistant High-Performance Sun II Tempered glass is available by description.

Glass - Circle and Oval Window / Impact Resistant Monolithic Clear

Note:
Impact resistant Clear Laminated Monolithic glass is available by description.

Glass - Circle and Oval Window / Impact Resistant Monolithic Gray

Note:
Impact resistant Gray Laminated Monolithic glass is available by description.

400 Series Circle & Oval Windows (1991 to Present)

Stormwatch™ Protection (Coastal Product)

Frames (Impact Resistant)

Stops (Impact Resistant)				
Glass Stop - Arch / Inside / Optional Glazing (Impact Resistant)				
Unit No.	Wood	White	Dark Bronze	Black
CIR 20	1076534	9013891	9209120	9208941
CIR 24	1076536	9013894	9209123	9208944
CIR 30	1076538	9013897	9209126	9208947
OVL 1824/2418	1076540	9013953	9209170	9208991
OVL 2030/3020	1076542	9013956	9209173	9208994
OVL 3048/4830	1076544	9013959	9209176	9208997

Stop - Arch / Inside / Optional Glazing (Impact Resistant)				
Unit No.	Wood	White	Dark Bronze	Black
CIR 20	1076554	9013892	9209121	9208942
CIR 24	1076556	9013895	9209124	9208945
CIR 30	1076558	9013898	9209127	9208948
OVL 1824/2418	1076560	9013954	9209171	9208992
OVL 2030/3020	1076562	9013957	9209174	9208995
OVL 3048/4830	1076564	9013960	9209177	9208998

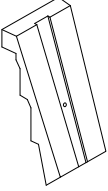
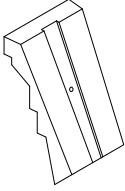
Transition Blocks (Impact Resistant)				
Transition Block - Narrow / Optional Glazing (Pair) (Impact Resistant)				
	Note: Use for Lami mono/optional glazing units All other units without art glass use transition block on page 14 Units with art glass use a unique transition block page 22	Unit No.	Color/ Species	Order No.
		OVL/CIR	Pine	9118981
			Maple	1076605
			Oak	9116879
			White	9068999
			Dark Bronze	9183826
Black	9183812			
Transition Block - Wide / Optional Glazing (Pair) (Impact Resistant)				
	Note: Use for Lami mono/optional glazing units	Unit No.		
		OVL/CIR	Pine	9118979
			Maple	1076636
			Oak	9116881
			White	9069003
			Dark Bronze	9183828
Black	9183814			

Frames (Impact Resistant)

Inside Casing (Impact Resistant)

Inside Casing - Arch / Colonial with Wide Transition Block (Impact Resistant)

Unit No.	2 1/4"		2 1/2"		3 1/2"	
	Maple	Oak	Maple	Oak	Maple	Oak
CIR 20	1075413	1075419	1075401	N/A	1075437	1075443
CIR 24	1075414	1075420	1075402	N/A	1075438	1075444
CIR 30	1075415	1075421	1075403	N/A	1075439	1075445
OVL 1824/2418	1075416	1075422	1075404	N/A	1075440	1075446
OVL 2030/3020	1075417	1075423	1075405	N/A	1075441	1075447
OVL 3048/4830	1075418	1075424	1075406	N/A	1075442	1075448

Inside Casing - Arch / Ranch with Wide Transition Block (Impact Resistant)

Unit No.	2 1/4"		2 1/2"	
	Maple	Oak	Maple	Oak
CIR 20	1075425	1075431	1075407	N/A
CIR 24	1075426	1075432	1075408	N/A
CIR 30	1075427	1075433	1075409	N/A
OVL 1824/2418	1075428	1075434	1075410	N/A
OVL 2030/3020	1075429	1075435	1075411	N/A
OVL 3048/4830	1075430	1075436	1075412	N/A

Block - Transition Casing / Wide

Unit No.	2 1/4" and 2 1/4"			3 1/2"		
	Pine	Maple	Oak	Pine	Maple	Oak
All Units	9074400	1075449	1075450	9074401	1075451	1075452

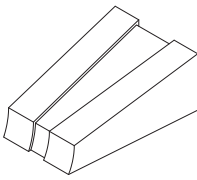

Extension Jambs (Impact Resistant)

Note:

Use standard window extension jambs, [page 18](#).

400 Series Circle & Oval Windows (1991 to Present)

Stormwatch™ Protection (Coastal Product)

Frames (Impact Resistant)

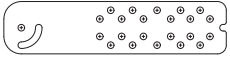
Jamb Clip Kit (Impact Resistant)												
Jamb Clip Kit - 6" (Impact Resistant)												
												
<p>Kit includes: Jamb clips and 3 sets of screws for Tilt-Wash Windows, Casement/Awning Windows, and specialty windows.</p> <p>Note: For use with pre-applied extension jambs. Made of 304 annealed stainless steel, making it compatible with ACQ treated lumber. These clips are approved for use with all Stormwatch products and for Miami-Dade County. The clips are pre-punched with holes for unit installation in wall thicknesses from 4-9/16" to 7-1/8". Additional pre-punched holes are available to compensate for wall thickness variations.</p>	<table border="1" style="width: 100%; border-collapse: collapse;"> <thead> <tr> <th style="text-align: center;">Quantity</th> <th style="text-align: center;">Clip Dimensions</th> <th style="text-align: center;">Order No.</th> </tr> </thead> <tbody> <tr> <td style="text-align: center;">14 clips</td> <td style="text-align: center;">6 3/8 x 1 1/2</td> <td style="text-align: center;">9014870</td> </tr> <tr> <td style="text-align: center;">500 clips</td> <td></td> <td style="text-align: center;">1376707</td> </tr> </tbody> </table>	Quantity	Clip Dimensions	Order No.	14 clips	6 3/8 x 1 1/2	9014870	500 clips		1376707		
Quantity	Clip Dimensions	Order No.										
14 clips	6 3/8 x 1 1/2	9014870										
500 clips		1376707										

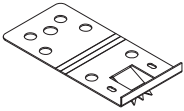
Installation Clips (Impact Resistant)				
Installation Clip Kit (Impact Resistant)				
	<p>Kit includes: 14 - Side clips 28 - 8-18 x 1-1/4 PH FL 316 SS PASS TYP screws</p>	<table border="1" style="width: 100%; border-collapse: collapse;"> <thead> <tr> <th style="text-align: center;">Order No.</th> </tr> </thead> <tbody> <tr> <td style="text-align: center;">2299104</td> </tr> </tbody> </table>	Order No.	2299104
Order No.				
2299104				

Notes

Service Replacement

Service Replacement Only Parts

Service Replacement Only Parts

Note:

This section is specifically designed for parts that should only be ordered if a Field Service Manager/Service Provider has requested them to be ordered or if the customer agrees to also pay for a non-warranty repair/replace service job (subject to availability) for these parts to be installed. We do not recommend anyone other than a trained AW employee or Service Provider install these parts due to the complexity of installation, modifications required for installation and/or requirement of special tools.

Service Replacement Only Parts
