



PRODUCTO
CALDERAS DE MEDIA Y GRAN POTENCIA
CALDERAS DE PIE CONDENSACION COMMERCIAL
EUROCONDENS SGB H Y E
EUROCONDENS SGB 125





BAXI

222995027 0002 CALDERA EUROCONDENS SGB 125
ESPAÑA

	Nº	código	Descripción	Precio €
	001	7633400	PANEL FRONTAL SGB 125-300H	113,65
	002	000578899	CIERRE TAPA FRONTAL EAS SSP	4,25
	003	000694889	TRAVESAÑO SGB 125-300	60,50
	004	7715120	LATERAL DERECHO FRONTAL SGB 125-170 I	115,05
	005	7715122	LATERAL DERECHO TRASERO SGB 125-170 I	93,40
	006	7714223	LATERAL IZQUIERDO FRONTAL SGB 125-170 I	126,60
	007	7714225	LATERAL IZQUIERDO TRASERO SGB 125-170 I	100,20

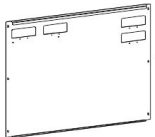
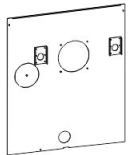

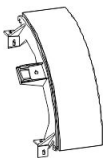
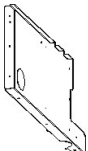

PRODUCTO
CALDERAS DE MEDIA Y GRAN POTENCIA
CALDERAS DE PIE CONDENSACION COMMERCIAL
EUROCONDENS SGB H Y E
EUROCONDENS SGB 125

BAXI

	Nº	código	Descripción	Precio €
	008	7637954	PANEL TRASERO SUPERIOR SGB 125-300 H	82,85
	009	7637955	PANEL TRASERO INFERIOR SGB 125-170 H	89,45
	010	7637957	PANEL SUPERIOR DELANTERO SGB 125 H	74,80
	011	7637959	PANEL SUPERIOR INTERMEDIO SGB 125-170 H	82,15
	012	7637961	PANEL SUPERIOR TRASERO SGB 125-170 H	81,00
	013	7637963	PANEL LATERAL CUADRO SGB H	14,25
	014	7637964	SEPARADOR PANEL LATERAL CUADRO SGB H	14,50
	015	000692397	SOPORTE CUERPO DERECHO SGB 125	75,75

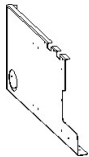
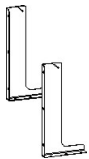
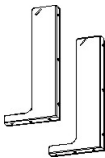
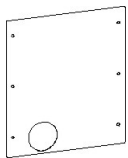

PRODUCTO
CALDERAS DE MEDIA Y GRAN POTENCIA
CALDERAS DE PIE CONDENSACION COMMERCIAL
EUROCONDENS SGB H Y E
EUROCONDENS SGB 125

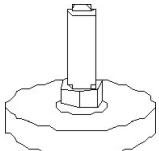
BAXI

	Nº	código	Descripción	Precio €
	016	000694681	SOPORTE CUERPO IZQUIERDO SGB 125	75,75
	017	000694735	ESCUADRA SOPORTE DERECHA SGB 125-300	42,05
	018	000694742	ESCUADRA SOPORTE IZQUIERDA SGB 125-300	39,70
	019	000694766	SOPORTE POSTERIOR SGB 125-300	42,80
	020	000684491	TAPA SALIDA HUMOS LATERAL SGB 125-170	16,85
	021	000694902	TAPA ENTRADA AIRE SGB 125-300	51,10
	022	000695039	TAPA SALIDA HUMOS SUPERIOR SGB 125-300	52,35
	023	000065795	PIE BASE CALDERA SGB 90-250C	4,70

PRODUCTO
CALDERAS DE MEDIA Y GRAN POTENCIA
CALDERAS DE PIE CONDENSACION COMMERCIAL
EUROCONDENS SGB H Y E
EUROCONDENS SGB 125

BAXI

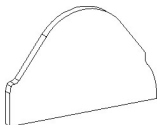
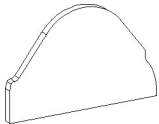
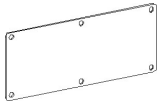
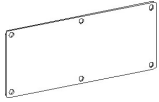
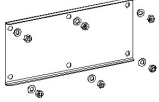
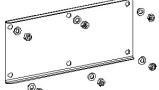
	Nº	código	Descripción	Precio €
	030	000695046	CUERPO CALDERA SGB 125E	4 475,40
	030	000695046	CUERPO CALDERA SGB 125E	4 475,40
	031	000695282	AISLANTE CÁMARA COMBUSTIÓN SGB 125-300	53,40
	031	000695282	AISLANTE CÁMARA COMBUSTIÓN SGB 125-300	53,40
	032	000936712	JUNTA COLECTOR CONDENSADOS SGB C	21,20
	032	000936712	JUNTA COLECTOR CONDENSADOS SGB C	21,20
	033	000936309	TAPA COLECTOR CONDENSADOS SGB C	21,75
	033	000936309	TAPA COLECTOR CONDENSADOS SGB C	21,75



PRODUCTO
CALDERAS DE MEDIA Y GRAN POTENCIA
CALDERAS DE PIE CONDENSACION COMMERCIAL
EUROCONDENS SGB H Y E
EUROCONDENS SGB 125

BAXI

	Nº	código	Descripción	Precio €
	034	000695312	AISLANTE POSTERIOR SGB 125-300 (PEQUEÑO)	41,20
	034	000695312	AISLANTE POSTERIOR SGB 125-300 (PEQUEÑO)	41,20
	035	000695329	AISLANTE POSTERIOR SGB 125-300	44,35
	036	000695336	AISLANTE FRONTAL SGB 125-300	46,10
	037	000695343	SOPORTE AISLANTE POSTERIOR SGB 125-170	66,25
	038	000695367	SOPORTE AISLANTE FRONTAL SGB 125-170	76,20
	039	000695435	AISLANTE IZQUIERDO CUERPO SGB 125	52,20
	039	000695435	AISLANTE IZQUIERDO CUERPO SGB 125	52,20



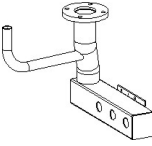
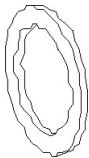
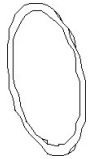
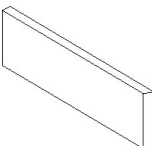

PRODUCTO
CALDERAS DE MEDIA Y GRAN POTENCIA
CALDERAS DE PIE CONDENSACION COMMERCIAL
EUROCONDENS SGB H Y E
EUROCONDENS SGB 125

BAXI

	Nº	código	Descripción	Precio €
	039	000695480	AISLANTE DERECHO CUERPO SGB 125	48,70
	040	000695534	ABRAZADERA AISLANTE 370mm SGB 125	29,90
	041	000695589	PLACA SOPORTE AISLANTE SGB 125-170	30,80
	042	000695107	COLECTOR IDA SGB 125	507,20
	043	000696005	JUNTA EPDM 54x40x3 SGB 125-300	5,50
	044	000695091	JUNTA TEFL 62x54x0,15 SGB 125-300	3,80
	045	000695626	AISLANTE IDA SGB 125-170	32,90
	046	000695664	SOPORTE AISLANTE SGB 125-170	36,10

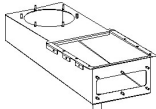
PRODUCTO
CALDERAS DE MEDIA Y GRAN POTENCIA
CALDERAS DE PIE CONDENSACION COMMERCIAL
EUROCONDENS SGB H Y E
EUROCONDENS SGB 125

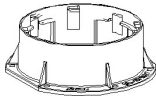
BAXI

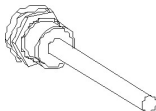
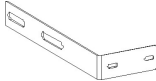
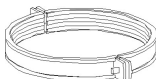
	Nº	código	Descripción	Precio €
	047	7714231	COLECTOR RETORNO SGB 125 I	539,75
	048	000695206	COLECTOR CONDENSADOS SGB 125	620,15
	049	000684385	JUNTA COLECTOR SALIDA HUMOS Ø160 SGB 125-170	15,30
	050	000684392	CONEXIÓN SALIDA HUMOS Ø160 SGB 125-170	77,90
	051	000695275	JUNTA SALIDA HUMOS Ø160 SGB 125-170	21,65
	052	000577373	VAINA DE INMERSIÓN	16,65
	053	000695381	ESCUADRA FIJACIÓN SALIDA HUMOS SGB 125-300	13,80
	054	000695398	ABRAZADERA SALIDA HUMOS Ø160 SGB 125-170	15,15

PRODUCTO
CALDERAS DE MEDIA Y GRAN POTENCIA
CALDERAS DE PIE CONDENSACION COMMERCIAL
EUROCONDENS SGB H Y E
EUROCONDENS SGB 125

BAXI

	Nº	código	Descripción	Precio €
	055	000695411	SALIDA HUMOS Ø160 SGB 125-170	127,50
	056	000695701	SIFÓN SGB 125-300	60,85
	057	000695718	ADAPTADOR 3/4" SIFÓN SGB 125-300	11,35
	058	000992510	ABRAZADERA 16/25 SIFÓN SGB 125-300	4,85
	060	000695725	CONJUNTO COMBUSTIÓN SGB 125	2 225,80
	061	000692236	JUNTA PLACA QUEMADOR SGB 125-300	44,45
	062	000695770	AISLANTE PLACA QUEMADOR SGB 125-170	39,25
	063	000692175	QUEMADOR SGB 125	467,30







PRODUCTO
CALDERAS DE MEDIA Y GRAN POTENCIA
CALDERAS DE PIE CONDENSACION COMMERCIAL
EUROCONDENS SGB H Y E
EUROCONDENS SGB 125

BAXI

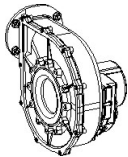
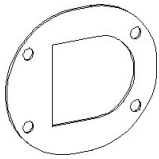
	Nº	código	Descripción	Precio €
	064	000692229	JUNTA QUEMADOR SGB 125-300	11,35
	065	000695831	TORNILLO FIJACION TUBO QUEMADOR SGB 125-300 H	9,65
	066	000936736	JUNTA MIRILLA SGB C	6,00
	067	000972338	KIT MIRILLA WBC/WBK/WBS	9,65
	068	7658430	ELECTRODO ENCENDIDO SGB125-300	25,60
	069	000646635	JUNTA ELECTRODO ENCENDIDO SGB 125-300	9,35
	070	000692366	SONDA IONIZACIÓN SGB 125-300	34,30
	071	000646628	JUNTA Sonda IONIZACIÓN SGB 125-300	8,25

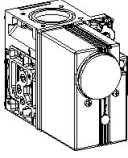
PRODUCTO
CALDERAS DE MEDIA Y GRAN POTENCIA
CALDERAS DE PIE CONDENSACION COMMERCIAL
EUROCONDENS SGB H Y E
EUROCONDENS SGB 125

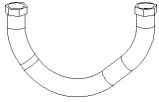
BAXI

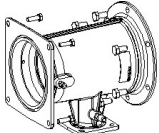
	Nº	código	Descripción	Precio €
	072	000692243	VENTILADOR SGB 125-170	706,40
	073	000692250	JUNTA VENTILADOR SGB 125-170	16,85
	074	000652155	JUNTA VENTURI Ø110x3,5 SGB 125-300	7,40
	075	000692281	VÁLVULA GAS VR415 SGB 125-170	774,70
	076	000517362	JUNTA VÁLVULA GAS SGB 125	5,10
	077	000695800	TUBO GAS 1" SGB 125	91,10
	078	000982245	JUNTA TUBO GAS 1" SGB 125	3,45
	079	000696067	VENTURI SGB 125	235,15

PRODUCTO
CALDERAS DE MEDIA Y GRAN POTENCIA
CALDERAS DE PIE CONDENSACION COMMERCIAL
EUROCONDENS SGB H Y E
EUROCONDENS SGB 125

BAXI

Nº	código	Descripción	Precio €
080	000696104	TAPON VENTURI SGB 125-300 H	6,05

081	000695947	ENTRADA AIRE 559mm SGB 125-170	52,95
-----	-----------	--------------------------------	-------

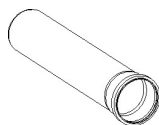

082	000695985	ENTRADA AIRE 800mm SGB 125-170	52,95
-----	-----------	--------------------------------	-------



083	000695930	CODO 87° SGB 125-300	32,90
-----	-----------	----------------------	-------

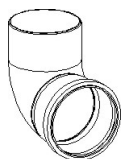

084	000695824	ANTIRRETORNO ENTRADA AIRE SGB 125-300	58,25
-----	-----------	---------------------------------------	-------



085	000694933	SILENCIADOR ENTRADA AIRE SGB 125-300	104,05
-----	-----------	--------------------------------------	--------

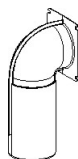

086	000695022	SOPORTE VENTURI SGB 125-300	54,75
-----	-----------	-----------------------------	-------

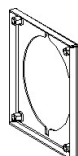

087	7308233	TAPA CAMARA COMBUSTION SGB	273,30
-----	---------	----------------------------	--------

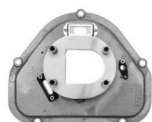

PRODUCTO
CALDERAS DE MEDIA Y GRAN POTENCIA
CALDERAS DE PIE CONDENSACION COMMERCIAL
EUROCONDENS SGB H Y E
EUROCONDENS SGB 125

BAXI

Nº	código	Descripción	Precio €
090	7715136	PLACA ELECTRÓNICA LMS 14 SGB E/H/I	395,15
091	000681483	CUBIERTA PLACA ELECTRÓNICA SGB 125-300	19,00
			
092	7637965	PANEL FRONTAL ISR SGB 125-300 H	63,95
093	7637966	TAPA ISR SGB 125-300 H	15,65
094	000627436	MANDO GIRATORIO	3,80
			
096	000627405	INTERRUPTOR GENERAL	5,65
			
097	000627450	PULSADOR DE BLOQUEO QUEMADOR	6,55
			
098	7637968	TAPA CUADRO CONTROL ISR SGB H	51,55

PRODUCTO
CALDERAS DE MEDIA Y GRAN POTENCIA
CALDERAS DE PIE CONDENSACION COMMERCIAL
EUROCONDENS SGB H Y E
EUROCONDENS SGB 125

BAXI

Nº	código	Descripción	Precio €
099	7308202	PRESOSTATO AGUA SGB I	38,25
100	000659147	JUNTA 13x18x2 SGB 125-300	6,10
101	000664561	SONDA QAK36 SGB 125-300	31,25
101	000664561	SONDA QAK36 SGB 125-300	31,25
102	000636070	JUNTA Sonda IDA INMERSIÓN	4,95
102	000636070	JUNTA Sonda IDA INMERSIÓN	4,95
200	7310968	ENVOLVENTE FILTRO NEOP 300 SGB H	221,95
202	7310969	TAPA MANTENIMIENTO NEOP 300 SGB H	56,25

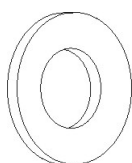
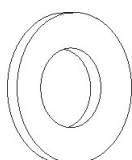
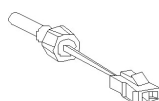
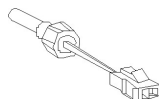
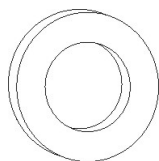

PRODUCTO
CALDERAS DE MEDIA Y GRAN POTENCIA
CALDERAS DE PIE CONDENSACION COMMERCIAL
EUROCONDENS SGB H Y E
EUROCONDENS SGB 125

BAXI

Nº	código	Descripción	Precio €
203	7310970	TAPA CON DIFUSOR NEOP 300 SGB H	84,25
207	7310973	AUMENTADOR PRESION NEOP 300 SGB H	141,90
208	000677608	MANGUERA AIRE NEOP 300/600 SGB H	28,55
210	7309079	TUBERIA NEOP 30/6000 SGB H	38,10
999	000681537	CONEXIÓN ENTRADA H1 SGB E	5,75
999	000508933	JUNTA BRIDA SOLDAR 85/115x4 SGB 125-300	11,15
999	000695589	PLACA SOPORTE AISLANTE SGB 125-170	30,80
999	000695664	SOPORTE AISLANTE SGB 125-170	36,10

PRODUCTO
CALDERAS DE MEDIA Y GRAN POTENCIA
CALDERAS DE PIE CONDENSACION COMMERCIAL
EUROCONDENS SGB H Y E
EUROCONDENS SGB 125

BAXI

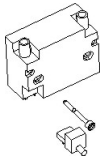

Nº	código	Descripción	Precio €
999	000695725	CONJUNTO COMBUSTIÓN SGB 125	2 225,80
999	000991209	TRANSFORMADOR ENCENDIDO EDI 052 F0030	59,15
999	000991216	CABLE ELECTRODO ENCENDIDO DERECHO	17,80
999	7310422	LOGOTIPO BAXI	12,40
999	7218854	TERMOSTATO SEGURIDAD SGB E	49,00
999	7780943	CABLEADO SGB 125-300 E-H	147,75
999	000695916	BRIDA SOLDAR Ø65 SGB 125-300	120,40
999	000508933	JUNTA BRIDA SOLDAR 85/115x4 SGB 125-300	11,15

PRODUCTO
CALDERAS DE MEDIA Y GRAN POTENCIA
CALDERAS DE PIE CONDENSACION COMMERCIAL
EUROCONDENS SGB H Y E
EUROCONDENS SGB 125

BAXI

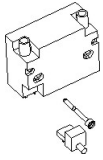

Nº	código	Descripción	Precio €
999	000991209	TRANSFORMADOR ENCENDIDO EDI 052 F0030	59,15
999	000991216	CABLE ELECTRODO ENCENDIDO DERECHO	17,80
999	000635936	FUSIBLE SGB	7,70
999	000695886	CONEXIÓN BUS 570mm SGB E	15,90
999	7307247	PRESOSTATO DIFERENCIAL SGB 400-610 E	95,70
999	000681506	CONEXIÓN ENTRADA H5 SGB E	5,75
999	000681513	CONEXIÓN ENTRADA H4 SGB E	5,75
999	000681520	CONEXIÓN ENTRADA UH SGB E	5,75

PRODUCTO
CALDERAS DE MEDIA Y GRAN POTENCIA
CALDERAS DE PIE CONDENSACION COMMERCIAL
EUROCONDENS SGB H Y E
EUROCONDENS SGB 125

BAXI

Nº	código	Descripción	Precio €
999	000681537	CONEXIÓN ENTRADA H1 SGB E	5,75
999	000627498	CONECTOR SONDA EXTERIOR 2 POLOS (ATF)	6,00
999	000671378	CONEXIÓN ENTRADA Bx3 SGB E	5,75
999	000671385	CONEXIÓN ENTRADA Bx2 SGB E	5,75
999	000671392	CONEXIÓN ENTRADA Bx1 SGB E	5,75
999	000688277	CONECTOR RED SGB E	6,00
999	000695848	CONECTOR SALIDA Qx1 SGB E	11,35
999	000641371	CONECTOR CIRCULADOR ACS	8,25

