

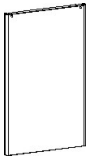





PRODUCTO
CALDERAS DE MEDIA Y GRAN POTENCIA
CALDERAS DE PIE CONDENSACION COMMERCIAL
EUROCONDENS SGB H Y E
EUROCONDENS SGB 170



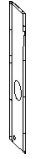
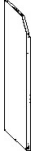

BAXI

222995028 0000 CALDERA EUROCONDENS SGB 170
ESPAÑA

| | Nº | código | Descripción | Precio € |
|---|-----|-----------|---|----------|
|  | 001 | 000695015 | TAPA FRONTAL SGB 125-300 | 111,00 |
|  | 002 | 000578899 | CIERRE TAPA FRONTAL EAS SSP | 4,25 |
|  | 003 | 000694889 | TRAVESAÑO SGB 125-300 | 60,50 |
|  | 004 | 000694773 | LATERAL DERECHO DELANTERO SGB 125-170 | 111,00 |
|  | 005 | 000694797 | LATERAL DERECHO POSTERIOR SGB 125-170 | 85,90 |
|  | 006 | 000694827 | LATERAL IZQUIERDO DELANTERO SGB 125-170 | 111,00 |
|  | 007 | 000694841 | LATERAL IZQUIERDO POSTERIOR SGB 125-170 | 95,20 |

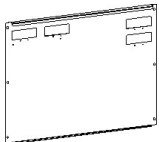
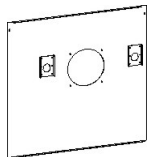



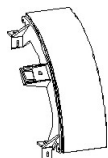
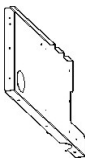
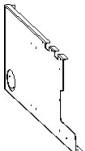

PRODUCTO
CALDERAS DE MEDIA Y GRAN POTENCIA
CALDERAS DE PIE CONDENSACION COMMERCIAL
EUROCONDENS SGB H Y E
EUROCONDENS SGB 170

BAXI

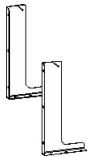
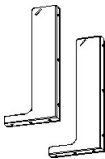
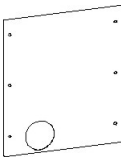
| | Nº | código | Descripción | Precio € |
|---|-----|-----------|-----------------------------------|----------|
|  | 008 | 000694940 | TAPA TRASERA SUPERIOR SGB 125-300 | 80,65 |
|  | 009 | 000694919 | TAPA TRASERA INFERIOR SGB 125-170 | 91,30 |
|  | 010 | 000694957 | TAPA SUPERIOR DELANTERA SGB 125 | 73,90 |
|  | 011 | 000694971 | TAPA SUPERIOR CENTRAL SGB 125-170 | 82,65 |
|  | 012 | 000694995 | TAPA SUPERIOR TRASERA SGB 125-170 | 81,40 |
|  | 014 | 000643276 | TAPA CENTRAL LATERAL CUADRO SGB C | 56,10 |
|  | 015 | 000692403 | SOPORTE CUERPO DERECHO SGB 170 | 75,75 |
|  | 016 | 000694698 | SOPORTE CUERPO IZQUIERDO SGB 170 | 75,75 |

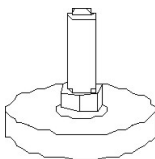

PRODUCTO
CALDERAS DE MEDIA Y GRAN POTENCIA
CALDERAS DE PIE CONDENSACION COMMERCIAL
EUROCONDENS SGB H Y E
EUROCONDENS SGB 170

BAXI

| | Nº | código | Descripción | Precio € |
|---|-----|-----------|--|----------|
|  | 017 | 000694735 | ESCUADRA SOPORTE DERECHA SGB 125-300 | 42,05 |
|  | 018 | 000694742 | ESCUADRA SOPORTE IZQUIERDA SGB 125-300 | 39,70 |
|  | 019 | 000694766 | SOPORTE POSTERIOR SGB 125-300 | 42,80 |
|  | 020 | 000684491 | TAPA SALIDA HUMOS LATERAL SGB 125-170 | 16,85 |
|  | 021 | 000694902 | TAPA ENTRADA AIRE SGB 125-300 | 51,10 |
|  | 022 | 000695039 | TAPA SALIDA HUMOS SUPERIOR SGB 125-300 | 52,35 |
|  | 023 | 000065795 | PIE BASE CALDERA SGB 90-250C | 4,70 |
|  | 030 | 000695053 | CUERPO CALDERA SGB 170E | 5 319,20 |

PRODUCTO
CALDERAS DE MEDIA Y GRAN POTENCIA
CALDERAS DE PIE CONDENSACION COMMERCIAL
EUROCONDENS SGB H Y E
EUROCONDENS SGB 170

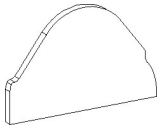
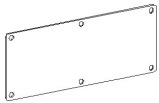
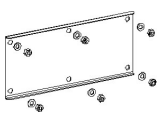
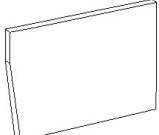
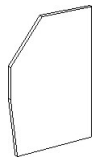
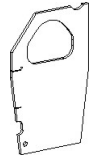
BAXI

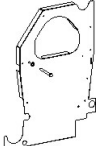
| | Nº | código | Descripción | Precio € |
|---|-----|-----------|--|----------|
|  | 031 | 000695282 | AISLANTE CÁMARA COMBUSTIÓN SGB 125-300 | 53,40 |
|  | 032 | 000936712 | JUNTA COLECTOR CONDENSADOS SGB C | 21,20 |
|  | 033 | 000936309 | TAPA COLECTOR CONDENSADOS SGB C | 21,75 |
|  | 034 | 000695312 | AISLANTE POSTERIOR SGB 125-300 (PEQUEÑO) | 41,20 |
|  | 035 | 000695329 | AISLANTE POSTERIOR SGB 125-300 | 44,35 |
|  | 036 | 000695336 | AISLANTE FRONTAL SGB 125-300 | 46,10 |
|  | 037 | 000695343 | SOPORTE AISLANTE POSTERIOR SGB 125-170 | 66,25 |
|  | 038 | 000695367 | SOPORTE AISLANTE FRONTAL SGB 125-170 | 76,20 |

PRODUCTO
CALDERAS DE MEDIA Y GRAN POTENCIA
CALDERAS DE PIE CONDENSACION COMMERCIAL
EUROCONDENS SGB H Y E
EUROCONDENS SGB 170

BAXI

| | Nº | código | Descripción | Precio € |
|---|-----|-----------|-----------------------------------|----------|
|  | 039 | 000695442 | AISLANTE IZQUIERDO CUERPO SGB 170 | 56,95 |
|  | 040 | 000695541 | ABRAZADERA AISLANTE 463mm SGB 170 | 29,90 |
|  | 041 | 000695497 | AISLANTE DERECHO CUERPO SGB 170 | 51,95 |
|  | 042 | 000695114 | COLECTOR IDA SGB 170 | 507,20 |
|  | 043 | 000696005 | JUNTA EPDM 54x40x3 SGB 125-300 | 5,50 |
|  | 044 | 000695091 | JUNTA TEFL 62x54x0,15 SGB 125-300 | 3,80 |
|  | 045 | 000695626 | AISLANTE IDA SGB 125-170 | 32,90 |
|  | 047 | 000695169 | COLECTOR RETORNO SGB 170 | 542,00 |

PRODUCTO
CALDERAS DE MEDIA Y GRAN POTENCIA
CALDERAS DE PIE CONDENSACION COMMERCIAL
EUROCONDENS SGB H Y E
EUROCONDENS SGB 170

BAXI

| | Nº | código | Descripción | Precio € |
|---|-----|-----------|--|----------|
|  | 048 | 000695213 | COLECTOR CONDENSADOS SGB 170 | 636,90 |
|  | 049 | 000684385 | JUNTA COLECTOR SALIDA HUMOS Ø160 SGB 125-170 | 15,30 |
|  | 050 | 000684392 | CONEXIÓN SALIDA HUMOS Ø160 SGB 125-170 | 77,90 |
|  | 051 | 000695275 | JUNTA SALIDA HUMOS Ø160 SGB 125-170 | 21,65 |
|  | 052 | 000577373 | VAINA DE INMERSIÓN | 16,65 |
|  | 053 | 000695381 | ESCUADRA FIJACIÓN SALIDA HUMOS SGB 125-300 | 13,80 |
|  | 054 | 000695398 | ABRAZADERA SALIDA HUMOS Ø160 SGB 125-170 | 15,15 |
|  | 055 | 000695411 | SALIDA HUMOS Ø160 SGB 125-170 | 127,50 |



PRODUCTO
CALDERAS DE MEDIA Y GRAN POTENCIA
CALDERAS DE PIE CONDENSACION COMMERCIAL
EUROCONDENS SGB H Y E
EUROCONDENS SGB 170

BAXI

| | Nº | código | Descripción | Precio € |
|---|-----|-----------|-------------------------------------|----------|
|  | 056 | 000695701 | SIFÓN SGB 125-300 | 60,85 |
|  | 057 | 000695718 | ADAPTADOR 3/4" SIFÓN SGB 125-300 | 11,35 |
|  | 058 | 000992510 | ABRAZADERA 16/25 SIFÓN SGB 125-300 | 4,85 |
|  | 061 | 000692236 | JUNTA PLACA QUEMADOR SGB 125-300 | 44,45 |
|  | 062 | 000695770 | AISLANTE PLACA QUEMADOR SGB 125-170 | 39,25 |
|  | 063 | 000692182 | QUEMADOR SGB 170 | 533,35 |
|  | 064 | 000692229 | JUNTA QUEMADOR SGB 125-300 | 11,35 |
|  | 066 | 000936736 | JUNTA MIRILLA SGB C | 6,00 |



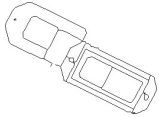
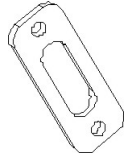
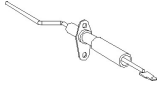

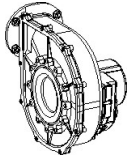
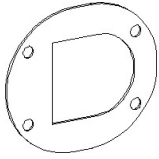
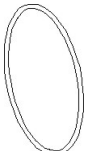
PRODUCTO
CALDERAS DE MEDIA Y GRAN POTENCIA
CALDERAS DE PIE CONDENSACION COMMERCIAL
EUROCONDENS SGB H Y E
EUROCONDENS SGB 170

BAXI

| | Nº | código | Descripción | Precio € |
|---|-----|-----------|---------------------------------------|----------|
|  | 067 | 000972338 | KIT MIRILLA WBC/WBK/WBS | 9,65 |
| | 068 | 7658430 | ELECTRODO ENCENDIDO SGB125-300 | 25,60 |
|  | 069 | 000646635 | JUNTA ELECTRODO ENCENDIDO SGB 125-300 | 9,35 |
|  | 070 | 000692366 | SONDA IONIZACIÓN SGB 125-300 | 34,30 |
|  | 071 | 000646628 | JUNTA Sonda IONIZACIÓN SGB 125-300 | 8,25 |
|  | 072 | 000692243 | VENTILADOR SGB 125-170 | 706,40 |
|  | 073 | 000692250 | JUNTA VENTILADOR SGB 125-170 | 16,85 |
|  | 074 | 000652155 | JUNTA VENTURI Ø110x3,5 SGB 125-300 | 7,40 |

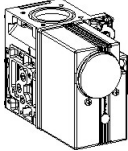
PRODUCTO
CALDERAS DE MEDIA Y GRAN POTENCIA
CALDERAS DE PIE CONDENSACION COMMERCIAL
EUROCONDENS SGB H Y E
EUROCONDENS SGB 170

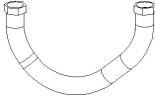
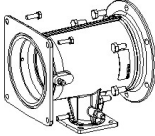
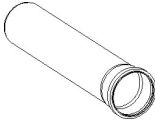
BAXI

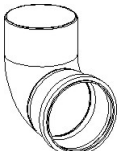
| | Nº | código | Descripción | Precio € |
|---|-----|-----------|--------------------------------|----------|
|  | 075 | 000692281 | VÁLVULA GAS VR415 SGB 125-170 | 774,70 |
|  | 076 | 000695794 | JUNTA VÁLVULA GAS SGB 170-300 | 3,80 |
|  | 077 | 000695817 | TUBO GAS 1" 1/2 SGB 170-300 | 234,35 |
| | 078 | 7306749 | JUNTA TORICA GAS SGB | 6,75 |
|  | 079 | 000696074 | VENTURI SGB 170-215 | 235,15 |
|  | 081 | 000695947 | ENTRADA AIRE 559mm SGB 125-170 | 52,95 |
|  | 082 | 000695985 | ENTRADA AIRE 800mm SGB 125-170 | 52,95 |
|  | 083 | 000695930 | CODO 87° SGB 125-300 | 32,90 |

PRODUCTO
CALDERAS DE MEDIA Y GRAN POTENCIA
CALDERAS DE PIE CONDENSACION COMMERCIAL
EUROCONDENS SGB H Y E
EUROCONDENS SGB 170

BAXI

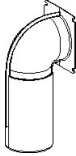
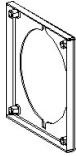
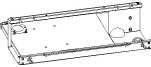
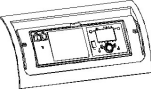
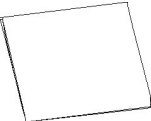
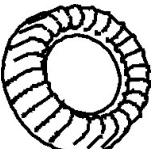
| | Nº | código | Descripción | Precio € |
|---|-----|-----------|--|----------|
|  | 084 | 000695824 | ANTIRRETORNO ENTRADA AIRE SGB 125-300 | 58,25 |
|  | 085 | 000694933 | SILENCIADOR ENTRADA AIRE SGB 125-300 | 104,05 |
|  | 086 | 000695022 | SOPORTE VENTURI SGB 125-300 | 54,75 |
| | 090 | 7715136 | PLACA ELECTRÓNICA LMS 14 SGB E/H/I | 395,15 |
|  | 091 | 000681483 | CUBIERTA PLACA ELECTRÓNICA SGB 125-300 | 19,00 |
|  | 092 | 000695862 | PANEL FRONTAL ISR SGB 125-300 | 62,65 |
|  | 093 | 000695879 | TAPA ISR SGB 125-300 | 38,45 |
|  | 094 | 000627436 | MANDO GIRATORIO | 3,80 |

PRODUCTO
CALDERAS DE MEDIA Y GRAN POTENCIA
CALDERAS DE PIE CONDENSACION COMMERCIAL
EUROCONDENS SGB H Y E
EUROCONDENS SGB 170

BAXI

| | Nº | código | Descripción | Precio € |
|---|-----|-----------|-----------------------------------|----------|
|  | 096 | 000627405 | INTERRUPTOR GENERAL | 5,65 |
|  | 097 | 000627450 | PULSADOR DE BLOQUEO QUEMADOR | 6,55 |
|  | 098 | 000620017 | TAPA CUADRO CONTROL ISR | 39,60 |
|  | 099 | 000682234 | PRESOSTATO TYP 901.41 SGB 125-300 | 53,45 |
|  | 100 | 000659147 | JUNTA 13x18x2 SGB 125-300 | 6,10 |
|  | 101 | 000664561 | SONDA QAK36 SGB 125-300 | 31,25 |
|  | 102 | 000636070 | JUNTA Sonda IDA INMERSIÓN | 4,95 |
| | 999 | 000695886 | CONEXIÓN BUS 570mm SGB E | 15,90 |

PRODUCTO
CALDERAS DE MEDIA Y GRAN POTENCIA
CALDERAS DE PIE CONDENSACION COMMERCIAL
EUROCONDENS SGB H Y E
EUROCONDENS SGB 170

BAXI

| Nº | código | Descripción | Precio € |
|-----|-----------|---------------------------------------|----------|
| 999 | 000681506 | CONEXIÓN ENTRADA H5 SGB E | 5,75 |
| 999 | 000681513 | CONEXIÓN ENTRADA H4 SGB E | 5,75 |
| 999 | 000681520 | CONEXIÓN ENTRADA UH SGB E | 5,75 |
| 999 | 000681537 | CONEXIÓN ENTRADA H1 SGB E | 5,75 |
| 999 | 000627498 | CONECTOR Sonda EXTERIOR 2 POLOS (ATF) | 6,00 |
| 999 | 000671378 | CONEXIÓN ENTRADA Bx3 SGB E | 5,75 |
| 999 | 000671385 | CONEXIÓN ENTRADA Bx2 SGB E | 5,75 |
| 999 | 000671392 | CONEXIÓN ENTRADA Bx1 SGB E | 5,75 |

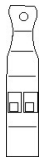

PRODUCTO
CALDERAS DE MEDIA Y GRAN POTENCIA
CALDERAS DE PIE CONDENSACION COMMERCIAL
EUROCONDENS SGB H Y E
EUROCONDENS SGB 170

BAXI

| Nº | código | Descripción | Precio € |
|-----|-----------|---|----------|
| 999 | 000688277 | CONECTOR RED SGB E | 6,00 |
| 999 | 000695848 | CONECTOR SALIDA Qx1 SGB E | 11,35 |
| 999 | 000641371 | CONECTOR CIRCULADOR ACS | 8,25 |
| 999 | 000695916 | BRIDA SOLDAR Ø65 SGB 125-300 | 120,40 |
| 999 | 000508933 | JUNTA BRIDA SOLDAR 85/115x4 SGB 125-300 | 11,15 |
| 999 | 000695589 | PLACA SOPORTE AISLANTE SGB 125-170 | 30,80 |
| 999 | 000695664 | SOPORTE AISLANTE SGB 125-170 | 36,10 |
| 999 | 000695732 | CONJUNTO COMBUSTIÓN SGB 170 | 2 380,20 |

PRODUCTO
CALDERAS DE MEDIA Y GRAN POTENCIA
CALDERAS DE PIE CONDENSACION COMMERCIAL
EUROCONDENS SGB H Y E
EUROCONDENS SGB 170

BAXI

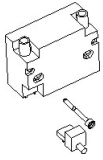

| Nº | código | Descripción | Precio € |
|-----|-----------|---------------------------------------|----------|
| 999 | 000991209 | TRANSFORMADOR ENCENDIDO EDI 052 F0030 | 59,15 |
| 999 | 000991216 | CABLE ELECTRODO ENCENDIDO DERECHO | 17,80 |
| 999 | 7310422 | LOGOTIPO BAXI | 12,40 |
| 999 | 7218854 | TERMOSTATO SEGURIDAD SGB E | 49,00 |
| 999 | 7780943 | CABLEADO SGB 125-300 E-H | 147,75 |