







PRODUCTO
CALDERAS DE MEDIA Y GRAN POTENCIA
CALDERAS DE PIE CONDENSACION COMMERCIAL
EUROCONDENS SGB H Y E
EUROCONDENS SGB 300





BAXI

222995031 0001 CALDERA EUROCONDENS SGB 300
ESPAÑA

	Nº	código	Descripción	Precio €
	001	7633400	PANEL FRONTAL SGB 125-300H	113,65
	002	000578899	CIERRE TAPA FRONTAL EAS SSP	4,25
	003	000694889	TRAVESAÑO SGB 125-300	60,50
	004	7633402	LATERAL DCHO DELANTERO SGB 215-300 H	116,90
	005	7658451	LATERAL DERECHO POSTERIOR SGB 300H	95,70
	006	7633407	LATERAL IZQDO DELANTERO SGB 215-300 H	116,90
	007	7637952	LATERAL IZQDO TRASERO SGB 260H	105,65

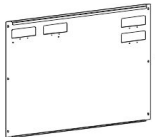
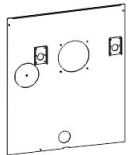

PRODUCTO
CALDERAS DE MEDIA Y GRAN POTENCIA
CALDERAS DE PIE CONDENSACION COMMERCIAL
EUROCONDENS SGB H Y E
EUROCONDENS SGB 300

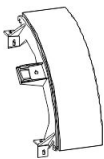
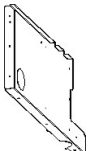
BAXI

	Nº	código	Descripción	Precio €
	008	7637954	PANEL TRASERO SUPERIOR SGB 125-300 H	82,85
	009	7637956	PANEL TRASERO INFERIOR SGB 215-300 H	108,95
	010	7637958	PANEL SUPERIOR DELANTERO SGB 170-300 H	73,75
	011	7637960	PANEL SUPERIOR INTERMEDIO SGB 215-300 H	93,90
	012	7637962	PANEL SUPERIOR TRASERO SGB 215-300 H	82,80
	013	7637963	PANEL LATERAL CUADRO SGB H	14,25
	014	7637964	SEPARADOR PANEL LATERAL CUADRO SGB H	14,50
	015	000692434	SOPORTE CUERPO DERECHO SGB 300	93,25

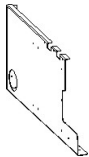
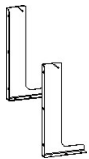
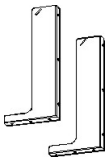
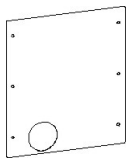

PRODUCTO
CALDERAS DE MEDIA Y GRAN POTENCIA
CALDERAS DE PIE CONDENSACION COMMERCIAL
EUROCONDENS SGB H Y E
EUROCONDENS SGB 300

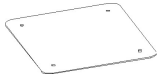
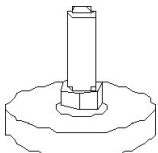
BAXI

	Nº	código	Descripción	Precio €
	016	000694728	SOPORTE CUERPO IZQUIERDO SGB 300	93,25
	017	000694735	ESCUADRA SOPORTE DERECHA SGB 125-300	42,05
	018	000694742	ESCUADRA SOPORTE IZQUIERDA SGB 125-300	39,70
	019	000694766	SOPORTE POSTERIOR SGB 125-300	42,80
	020	000694896	TAPA SALIDA HUMOS LATERAL SGB 215-300	54,35
	021	000694902	TAPA ENTRADA AIRE SGB 125-300	51,10
	022	000695039	TAPA SALIDA HUMOS SUPERIOR SGB 125-300	52,35
	023	000065795	PIE BASE CALDERA SGB 90-250C	4,70

PRODUCTO
CALDERAS DE MEDIA Y GRAN POTENCIA
CALDERAS DE PIE CONDENSACION COMMERCIAL
EUROCONDENS SGB H Y E
EUROCONDENS SGB 300

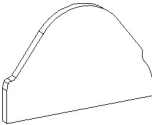
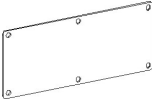
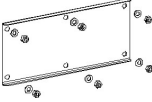
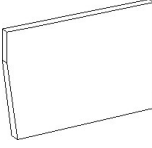
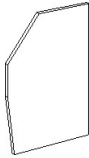
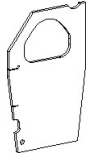
BAXI

	Nº	código	Descripción	Precio €
	030	000695084	CUERPO CALDERA SGB 300E	7 913,35
	031	000695282	AISLANTE CÁMARA COMBUSTIÓN SGB 125-300	53,40
	032	000936712	JUNTA COLECTOR CONDENSADOS SGB C	21,20
	033	000936309	TAPA COLECTOR CONDENSADOS SGB C	21,75
	034	000695312	AISLANTE POSTERIOR SGB 125-300 (PEQUEÑO)	41,20
	035	000695329	AISLANTE POSTERIOR SGB 125-300	44,35
	036	000695336	AISLANTE FRONTAL SGB 125-300	46,10
	037	000695350	SOPORTE AISLANTE POSTERIOR SGB 215-300	67,30



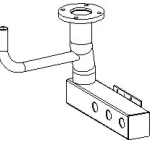

PRODUCTO
CALDERAS DE MEDIA Y GRAN POTENCIA
CALDERAS DE PIE CONDENSACION COMMERCIAL
EUROCONDENS SGB H Y E
EUROCONDENS SGB 300

BAXI

	Nº	código	Descripción	Precio €
	038	000695374	SOPORTE AISLANTE FRONTAL SGB 215-300	74,65
	039	000695473	AISLANTE IZQUIERDO CUERPO SGB 300	71,00
	039	000695527	AISLANTE DERECHO CUERPO SGB 300	62,80
	040	000695572	ABRAZADERA AISLANTE 742mm SGB 300	30,25
	041	000695619	PLACA SOPORTE AISLANTE SGB 300	31,95
	042	000695145	COLECTOR IDA SGB 300	593,65
	043	000696005	JUNTA EPDM 54x40x3 SGB 125-300	5,50
	044	000695091	JUNTA TEFL 62x54x0,15 SGB 125-300	3,80

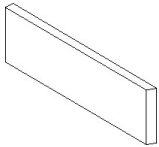
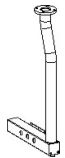
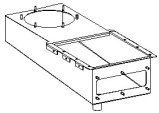
PRODUCTO
CALDERAS DE MEDIA Y GRAN POTENCIA
CALDERAS DE PIE CONDENSACION COMMERCIAL
EUROCONDENS SGB H Y E
EUROCONDENS SGB 300

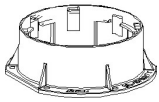
BAXI

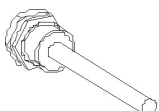
	Nº	código	Descripción	Precio €
	045	000695657	AISLANTE IDA SGB 300	33,95
	046	000695695	SOPORTE AISLANTE SGB 300	39,60
	047	000695190	COLECTOR RETORNO SGB 300	598,80
	048	000695244	COLECTOR CONDENSADOS SGB 300	796,55
	049	000695251	JUNTA COLECTOR SALIDA HUMOS Ø200 SGB 215-300	13,70
	050	000695268	CONEXIÓN SALIDA HUMOS Ø200 SGB 215-300	88,70
	051	000993432	JUNTA SALIDA HUMOS Ø200 SGB 215-300	26,30
	052	000577373	VAINA DE INMERSIÓN	16,65

PRODUCTO
CALDERAS DE MEDIA Y GRAN POTENCIA
CALDERAS DE PIE CONDENSACION COMMERCIAL
EUROCONDENS SGB H Y E
EUROCONDENS SGB 300

BAXI

Nº	código	Descripción	Precio €	
	053	000695381	ESCUADRA FIJACIÓN SALIDA HUMOS SGB 125-300	13,80
	054	000695404	ABRAZADERA SALIDA HUMOS Ø200 SGB 215-300	17,25
	055	000695428	SALIDA HUMOS Ø200 SGB 215-300	186,65
	056	000695701	SIFÓN SGB 125-300	60,85
	057	000695718	ADAPTADOR 3/4" SIFÓN SGB 125-300	11,35
	058	000992510	ABRAZADERA 16/25 SIFÓN SGB 125-300	4,85
	060	000695763	CONJUNTO COMBUSTIÓN SGB 300	2 872,45
	061	000692236	JUNTA PLACA QUEMADOR SGB 125-300	44,45



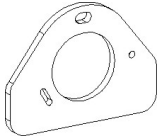
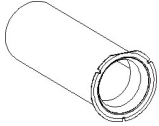
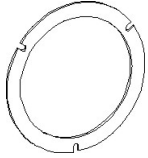
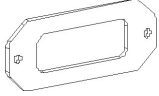
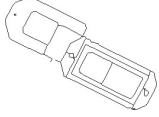
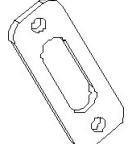

PRODUCTO
CALDERAS DE MEDIA Y GRAN POTENCIA
CALDERAS DE PIE CONDENSACION COMMERCIAL
EUROCONDENS SGB H Y E
EUROCONDENS SGB 300

BAXI

	Nº	código	Descripción	Precio €
	062	000695787	AISLANTE PLACA QUEMADOR SGB 215-300	39,95
	063	000692212	QUEMADOR SGB 300	708,90
	064	000692229	JUNTA QUEMADOR SGB 125-300	11,35
	065	000695831	TORNILLO FIJACION TUBO QUEMADOR SGB 125-300 H	9,65
	066	000936736	JUNTA MIRILLA SGB C	6,00
	067	000972338	KIT MIRILLA WBC/WBK/WBS	9,65
	068	7658430	ELECTRODO ENCENDIDO SGB125-300	25,60
	069	000646635	JUNTA ELECTRODO ENCENDIDO SGB 125-300	9,35

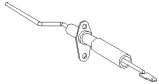
PRODUCTO
CALDERAS DE MEDIA Y GRAN POTENCIA
CALDERAS DE PIE CONDENSACION COMMERCIAL
EUROCONDENS SGB H Y E
EUROCONDENS SGB 300

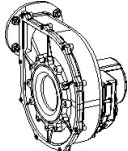
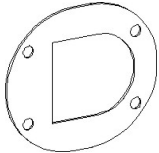
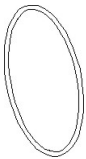
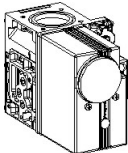
BAXI

	Nº	código	Descripción	Precio €
	070	000692366	SONDA IONIZACIÓN SGB 125-300	34,30
	071	000646628	JUNTA Sonda IONIZACIÓN SGB 125-300	8,25
	072	000692267	VENTILADOR SGB 215-300	991,10
	073	000692274	JUNTA VENTILADOR SGB 215-300	18,25
	074	000652155	JUNTA VENTURI Ø110x3,5 SGB 125-300	7,40
	075	000692646	VÁLVULA GAS VR425 SGB 260-300	953,75
	076	000695794	JUNTA VÁLVULA GAS SGB 170-300	3,80
	077	000695817	TUBO GAS 1" 1/2 SGB 170-300	234,35

PRODUCTO
CALDERAS DE MEDIA Y GRAN POTENCIA
CALDERAS DE PIE CONDENSACION COMMERCIAL
EUROCONDENS SGB H Y E
EUROCONDENS SGB 300

BAXI

Nº	código	Descripción	Precio €
078	7306749	JUNTA TORICA GAS SGB	6,75

079	000696098	VENTURI SGB 300	244,50
-----	-----------	-----------------	--------

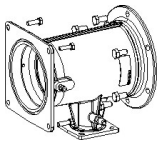

080	000696104	TAPON VENTURI SGB 125-300 H	6,05
-----	-----------	-----------------------------	------

081	000695978	ENTRADA AIRE 876mm SGB 300	52,95
-----	-----------	----------------------------	-------

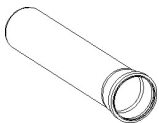

082	000695992	ENTRADA AIRE 944mm SGB 215-300	52,95
-----	-----------	--------------------------------	-------



083	000695930	CODO 87° SGB 125-300	32,90
-----	-----------	----------------------	-------

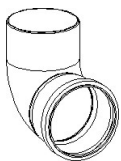

084	000695824	ANTIRRETORNO ENTRADA AIRE SGB 125-300	58,25
-----	-----------	---------------------------------------	-------



085	000694933	SILENCIADOR ENTRADA AIRE SGB 125-300	104,05
-----	-----------	--------------------------------------	--------

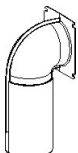

PRODUCTO
CALDERAS DE MEDIA Y GRAN POTENCIA
CALDERAS DE PIE CONDENSACION COMMERCIAL
EUROCONDENS SGB H Y E
EUROCONDENS SGB 300

BAXI

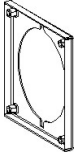
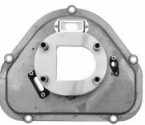
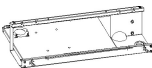
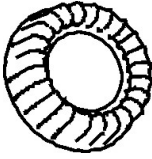
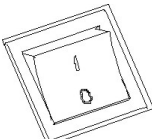
	Nº	código	Descripción	Precio €
	086	000695022	SOPORTE VENTURI SGB 125-300	54,75
	087	7308233	TAPA CAMARA COMBUSTION SGB	273,30
	090	7715136	PLACA ELECTRÓNICA LMS 14 SGB E/H/I	395,15
	091	000681483	CUBIERTA PLACA ELECTRÓNICA SGB 125-300	19,00
	092	7637965	PANEL FRONTAL ISR SGB 125-300 H	63,95
	093	7637966	TAPA ISR SGB 125-300 H	15,65
	094	000627436	MANDO GIRATORIO	3,80
	096	000627405	INTERRUPTOR GENERAL	5,65

PRODUCTO
CALDERAS DE MEDIA Y GRAN POTENCIA
CALDERAS DE PIE CONDENSACION COMMERCIAL
EUROCONDENS SGB H Y E
EUROCONDENS SGB 300

BAXI

	Nº	código	Descripción	Precio €
	097	000627450	PULSADOR DE BLOQUEO QUEMADOR	6,55
	098	7637968	TAPA CUADRO CONTROL ISR SGB H	51,55
	099	000682234	PRESOSTATO TYP 901.41 SGB 125-300	53,45
	100	000659147	JUNTA 13x18x2 SGB 125-300	6,10
	101	000664561	SONDA QAK36 SGB 125-300	31,25
	102	000636070	JUNTA Sonda IDA INMERSIÓN	4,95
	200	7310968	ENVOLVENTE FILTRO NEOP 300 SGB H	221,95
	202	7310969	TAPA MANTENIMIENTO NEOP 300 SGB H	56,25

PRODUCTO
CALDERAS DE MEDIA Y GRAN POTENCIA
CALDERAS DE PIE CONDENSACION COMMERCIAL
EUROCONDENS SGB H Y E
EUROCONDENS SGB 300

BAXI

Nº	código	Descripción	Precio €
203	7310970	TAPA CON DIFUSOR NEOP 300 SGB H	84,25
207	7310973	AUMENTADOR PRESION NEOP 300 SGB H	141,90
208	000677608	MANGUERA AIRE NEOP 300/600 SGB H	28,55
210	7309079	TUBERIA NEOP 30/6000 SGB H	38,10
999	000635936	FUSIBLE SGB	7,70
999	000695886	CONEXIÓN BUS 570mm SGB E	15,90
999	000681506	CONEXIÓN ENTRADA H5 SGB E	5,75
999	000681513	CONEXIÓN ENTRADA H4 SGB E	5,75

PRODUCTO
CALDERAS DE MEDIA Y GRAN POTENCIA
CALDERAS DE PIE CONDENSACION COMMERCIAL
EUROCONDENS SGB H Y E
EUROCONDENS SGB 300

BAXI

Nº	código	Descripción	Precio €
999	000681520	CONEXIÓN ENTRADA UH SGB E	5,75
999	000681537	CONEXIÓN ENTRADA H1 SGB E	5,75
999	000627498	CONECTOR SONDA EXTERIOR 2 POLOS (ATF)	6,00
999	000671378	CONEXIÓN ENTRADA Bx3 SGB E	5,75
999	000671385	CONEXIÓN ENTRADA Bx2 SGB E	5,75
999	000671392	CONEXIÓN ENTRADA Bx1 SGB E	5,75
999	000688277	CONECTOR RED SGB E	6,00
999	000695848	CONECTOR SALIDA Qx1 SGB E	11,35

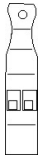

PRODUCTO
CALDERAS DE MEDIA Y GRAN POTENCIA
CALDERAS DE PIE CONDENSACION COMMERCIAL
EUROCONDENS SGB H Y E
EUROCONDENS SGB 300

BAXI

Nº	código	Descripción	Precio €
999	000641371	CONECTOR CIRCULADOR ACS	8,25
999	000695916	BRIDA SOLDAR Ø65 SGB 125-300	120,40
999	000508933	JUNTA BRIDA SOLDAR 85/115x4 SGB 125-300	11,15
999	000695619	PLACA SOPORTE AISLANTE SGB 300	31,95
999	000695695	SOPORTE AISLANTE SGB 300	39,60
999	000695763	CONJUNTO COMBUSTIÓN SGB 300	2 872,45
999	000991209	TRANSFORMADOR ENCENDIDO EDI 052 F0030	59,15
999	000991216	CABLE ELECTRODO ENCENDIDO DERECHO	17,80

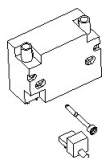

PRODUCTO
CALDERAS DE MEDIA Y GRAN POTENCIA
CALDERAS DE PIE CONDENSACION COMMERCIAL
EUROCONDENS SGB H Y E
EUROCONDENS SGB 300

BAXI

Nº	código	Descripción	Precio €
999	7310422	LOGOTIPO BAXI	12,40
999	7218854	TERMOSTATO SEGURIDAD SGB E	49,00
999	7780943	CABLEADO SGB 125-300 E-H	147,75
999	000695916	BRIDA SOLDAR Ø65 SGB 125-300	120,40
999	000508933	JUNTA BRIDA SOLDAR 85/115x4 SGB 125-300	11,15
999	000991209	TRANSFORMADOR ENCENDIDO EDI 052 F0030	59,15
999	000991216	CABLE ELECTRODO ENCENDIDO DERECHO	17,80
999	000635936	FUSIBLE SGB	7,70

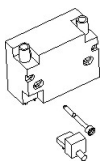

PRODUCTO
CALDERAS DE MEDIA Y GRAN POTENCIA
CALDERAS DE PIE CONDENSACION COMMERCIAL
EUROCONDENS SGB H Y E
EUROCONDENS SGB 300

BAXI

Nº	código	Descripción	Precio €
999	000695886	CONEXIÓN BUS 570mm SGB E	15,90
999	000681506	CONEXIÓN ENTRADA H5 SGB E	5,75
999	000681513	CONEXIÓN ENTRADA H4 SGB E	5,75
999	000681520	CONEXIÓN ENTRADA UH SGB E	5,75
999	000681537	CONEXIÓN ENTRADA H1 SGB E	5,75
999	000627498	CONECTOR Sonda EXTERIOR 2 POLOS (ATF)	6,00
999	000671378	CONEXIÓN ENTRADA Bx3 SGB E	5,75
999	000671385	CONEXIÓN ENTRADA Bx2 SGB E	5,75

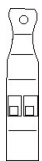

PRODUCTO
CALDERAS DE MEDIA Y GRAN POTENCIA
CALDERAS DE PIE CONDENSACION COMMERCIAL
EUROCONDENS SGB H Y E
EUROCONDENS SGB 300

BAXI

Nº	código	Descripción	Precio €
999	000671392	CONEXIÓN ENTRADA Bx1 SGB E	5,75
999	000688277	CONECTOR RED SGB E	6,00
999	000695848	CONECTOR SALIDA Qx1 SGB E	11,35
999	000641371	CONECTOR CIRCULADOR ACS	8,25
999	7780943	CABLEADO SGB 125-300 E-H	147,75