

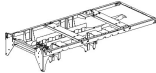

**PRODUCTO**  
**CALDERAS DE MEDIA Y GRAN POTENCIA**  
**CALDERAS DE PIE CONDENSACION COMMERCIAL**  
**EUROCONDENS SGB H Y E**  
**EUROCONDENS SGB 400**

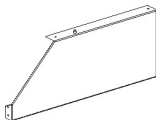
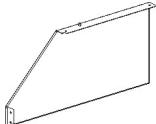

**BAXI**

**222995032 0002 CALDERA EUROCONDENS SGB 400**  
**ESPAÑA**

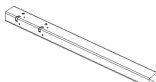
Nº	código	Descripción	Precio €
<b>001</b>	<b>7307130</b>	BASE CUERPO SGB 470-610 E	752,20
			
<b>002</b>	<b>7668873</b>	TAPA SUPERIOR CUADRO SGB 400-610 I	68,45
<b>003</b>	<b>7637970</b>	LATERAL DERECHO CUADRO SGB 400-610H	86,35
			
<b>004</b>	<b>7637971</b>	LATERAL IZQUIERDO CUADRO SGB 400-610H	86,35
			
<b>005</b>	<b>7307134</b>	SOPORTE INTERNO LARGO CUADRO SGB 400-610 E	51,10
			
<b>006</b>	<b>7307135</b>	SOPORTE INTERNO CORTO CUADRO SGB 400-610 E	30,70
			
<b>007</b>	<b>7307136</b>	TRAVESAÑO CUADRO DE CONTROL SGB 400-610 E	80,75
			



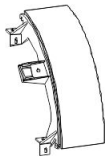
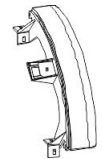
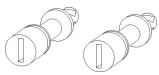

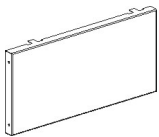
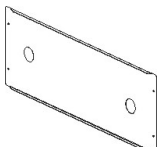

**PRODUCTO**  
**CALDERAS DE MEDIA Y GRAN POTENCIA**  
**CALDERAS DE PIE CONDENSACION COMMERCIAL**  
**EUROCONDENS SGB H Y E**  
**EUROCONDENS SGB 400**

**BAXI**

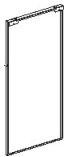
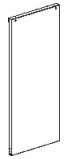
	Nº	código	Descripción	Precio €
	008	7637964	SEPARADOR PANEL LATERAL CUADRO SGB H	14,50
	009	7637963	PANEL LATERAL CUADRO SGB H	14,25
	010	000578899	CIERRE TAPA FRONTAL EAS SSP	4,25
	015	7668830	PANEL FRONTAL SGB 400-610 I	168,25
	016	7310422	LOGOTIPO BAXI	12,40
	017	7637973	LATERAL INFERIOR DELANTERO SGB 400H	43,55
	018	7637975	LATERAL INFERIOR TRASERO SGB 400-610H	37,85
	019	7637976	PANEL INFERIOR TRASERO SGB 400-610H	34,15

**PRODUCTO**  
**CALDERAS DE MEDIA Y GRAN POTENCIA**  
**CALDERAS DE PIE CONDENSACION COMMERCIAL**  
**EUROCONDENS SGB H Y E**  
**EUROCONDENS SGB 400**

**BAXI**

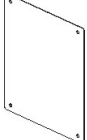
	Nº	código	Descripción	Precio €
	020	7637977	LATERAL IZQUIERDO DELANTERO SGB 400-610H	115,45
	021	7637978	LATERAL DERECHO DELANTERO SGB 400-610H	115,45
	022	7637979	LATERAL SGB 400H	136,70
	024	7637981	LATERAL IZQUIERDO POSTERIOR SGB 400-610H	111,45
	025	7637982	LATERAL DERECHO POSTERIOR SGB 400-610H	107,70
	026	7637983	TAPA ENTRADA DE AIRE LATERAL SGB 400-610H	28,10
	027	7637984	TAPA POSTERIOR SGB 400-610H	152,15
	028	7637988	TAPA ENTRADA AIRE POSTERIOR SGB 400-610H	17,25

**PRODUCTO**  
**CALDERAS DE MEDIA Y GRAN POTENCIA**  
**CALDERAS DE PIE CONDENSACION COMMERCIAL**  
**EUROCONDENS SGB H Y E**  
**EUROCONDENS SGB 400**

**BAXI**

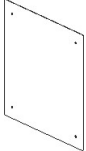
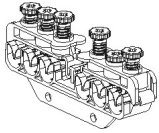
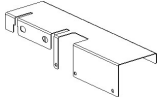
Nº	código	Descripción	Precio €	
	<b>029</b>	<b>7637989</b>	TAPA SALIDA DE HUMOS SGB 400-610H	19,85
	<b>030</b>	<b>7307152</b>	PASACABLES SGB 400-610 E	13,50
	<b>031</b>	<b>7637990</b>	SUPLEMENTO ENVOLVENTE SGB 400-610H	22,60
	<b>032</b>	<b>7668877</b>	PANEL SUPERIOR DELANTERO SGB 400 I	128,50
	<b>033</b>	<b>7668879</b>	PANEL SUPERIOR INTERMEDIO SGB 400 I	125,65
	<b>034</b>	<b>7668881</b>	PANEL SUPERIOR TRASERO SGB 400-610 I	123,10
	<b>040</b>	<b>7307159</b>	BASE CALDERA SGB 400 E	1 103,15
	<b>041</b>	<b>7307161</b>	BASE CALDERA FRONTAL SGB 400-610 E	378,65

**PRODUCTO**  
**CALDERAS DE MEDIA Y GRAN POTENCIA**  
**CALDERAS DE PIE CONDENSACION COMMERCIAL**  
**EUROCONDENS SGB H Y E**  
**EUROCONDENS SGB 400**

**BAXI**

Nº	código	Descripción	Precio €
042	7307162	SOPORTE SGB 400-610 E	13,95
043	7307163	PIE CALDERA SGB 400-610 E	36,85
044	7307164	BANDEJA RECOGIDA CONDENSADOS SGB 400 E	325,00
045	7307166	JUNTA BANDEJA RECOGIDA CONDENSADOS SGB 400-610 E	63,20
046	7307167	JUNTA 45X34X3 EPDM SGB 400-610 E	13,20
047	7307168	TUBO CONEXIÓN BANDEJA RECOGIDA CONDENSADOS SGB 400-610 E	23,20
048	7307169	SIFÓN SGB 400-610 E	55,10
049	7307170	TUBO EVACUACIÓN CONDENSADOS 218mm SGB 400-610 E	20,70

**PRODUCTO**  
**CALDERAS DE MEDIA Y GRAN POTENCIA**  
**CALDERAS DE PIE CONDENSACION COMMERCIAL**  
**EUROCONDENS SGB H Y E**  
**EUROCONDENS SGB 400**

**BAXI**

Nº	código	Descripción	Precio €
050	7307171	CODO 90° EVACUACIÓN CONDENSADOS SGB 400-610 E	17,50
051	7307172	TUBO EVACUACIÓN CONDENSADOS 400mm SGB 400-610 E	30,80
052	7307173	TUBO EVACUACIÓN CONDENSADOS 1500mm SGB 400-610 E	17,50
053	7307174	FIJACIÓN TUBOS SGB 400-610 E	10,10
054	7307175	ADAPTADOR SALIDA HUMOS SGB 400/610 E	88,70
055	7307178	JUNTA DN 250 SGB 400-610 E	15,30
056	7307179	TAPÓN REGISTRO LIMPIEZA SGB 400-610 E	18,85
057	7307180	JUNTA TAPÓN REGISTRO LIMPIEZA SGB 400-610 E	53,45

**PRODUCTO**  
**CALDERAS DE MEDIA Y GRAN POTENCIA**  
**CALDERAS DE PIE CONDENSACION COMMERCIAL**  
**EUROCONDENS SGB H Y E**  
**EUROCONDENS SGB 400**

**BAXI**

Nº	código	Descripción	Precio €
060	7307181	AISLANTE POSTERIOR SGB 400-610 E	61,20
061	7307182	AISLANTE POSTERIOR FINAL SGB 400-610 E	17,50
062	7307183	AISLANTE POSTERIOR MEDIO SGB 400-610 E	20,10
063	7307184	AISLANTE POSTERIOR INTERIOR SGB 400-610 E	22,00
064	7307185	VARILLA ROSCADA M6X70 SGB 400-610 E	10,00
065	7307186	AISLAMIENTO CUERPO CALDERA SGB 400 E	65,40
066	7307190	SUJECIÓN AISLANTE SGB 400 E	17,50
067	7307194	FIJACIÓN AISLANTE SGB 400 E	33,95

**PRODUCTO**  
**CALDERAS DE MEDIA Y GRAN POTENCIA**  
**CALDERAS DE PIE CONDENSACION COMMERCIAL**  
**EUROCONDENS SGB H Y E**  
**EUROCONDENS SGB 400**

**BAXI**

Nº	código	Descripción	Precio €
068	7307198	FIJACIÓN AISLANTE FRONTAL SGB 400-610 E	24,65
069	7307199	PLACA FIJACIÓN AISLANTE DERECHA SGB 400 E	39,70
070	7307203	PLACA AISLANTE DERECHA SGB 400 E	17,15
071	7307207	REGISTRO LIMPIEZA DERECHO SGB 400 E	95,80
072	7307211	JUNTA REGISTRO LIMPIEZA DERECHO SGB 400 E	95,65
073	7307215	CORDÓN ESTANQUEIDAD REGISTRO SGB 400-610 E	19,75
074	7307216	PLACA AISLAMIENTO FRONTAL SGB 400-610 E	39,40
075	7307217	PLACA AISLAMIENTO FRONTAL EXTERIOR SGB 400-610 E	16,65



**PRODUCTO**  
**CALDERAS DE MEDIA Y GRAN POTENCIA**  
**CALDERAS DE PIE CONDENSACION COMMERCIAL**  
**EUROCONDENS SGB H Y E**  
**EUROCONDENS SGB 400**

# BAXI

Nº	código	Descripción	Precio €
076	7307218	PLACA AISLAMIENTO FRONTAL INTERIOR SGB 400-610 E	17,80
077	7307219	CUERPO CALDERA SGB 400 E	12 339,10
078	7307223	MIRILLA COMPLETA SGB 400-610 E	12,20
079	7307224	CUBIERTA COMPLETA SGB 400-610 E	14,10
080	7307225	JUNTA TÓRICA 105X5 SGB 400-610 E	8,60
081	7307226	TUBO IDA SGB 400/610 E	724,00
082	000577373	VAINA DE INMERSIÓN	16,65
083	7307229	SONDA SGB 400-610 E	11,15

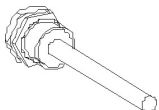

**PRODUCTO**  
**CALDERAS DE MEDIA Y GRAN POTENCIA**  
**CALDERAS DE PIE CONDENSACION COMMERCIAL**  
**EUROCONDENS SGB H Y E**  
**EUROCONDENS SGB 400**

**BAXI**

Nº	código	Descripción	Precio €
084	7307230	ELECTRODO DE ENCENDIDO Y SONDA DE IONIZACIÓN SGB 400-610 E	61,05
085	7307231	TAPA POSTERIOR SGB 400-610 E	93,50
086	7307232	JUNTA QUEMADOR/TAPA POSTERIOR SGB 400-610 E	21,45
087	7307233	AISLANTE CÁMARA COMBUSTIÓN SGB 400-610 E	16,55
088	7307234	ABRAZADERA AISLAMIENTO CÁMARA DE COMBUSTIÓN SGB 400-610 E	13,70
090	7307235	COLECTOR IDA SGB 400 E	219,70
091	7307239	TUBO CIEGO SGB 400 E	96,95
092	7307243	JUNTA TÓRICA 82X5 SGB 400-610 E	8,50

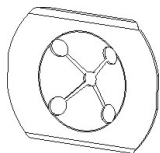
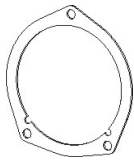

**PRODUCTO**  
**CALDERAS DE MEDIA Y GRAN POTENCIA**  
**CALDERAS DE PIE CONDENSACION COMMERCIAL**  
**EUROCONDENS SGB H Y E**  
**EUROCONDENS SGB 400**

**BAXI**

Nº	código	Descripción	Precio €
093	7714236	COLECTOR RETORNO SGB 400-610 I	728,95
094	7308202	PRESOSTATO AGUA SGB I	38,25
095	000695305	LLAVE VACIADO SGB 400-610H	17,25
096	7307245	TRANSFORMADOR DE ENCENDIDO SGB 400-610 E	26,65
097	7307246	PRESOSTATO AIRE SGB 400-610 E	133,00
098	7307247	PRESOSTATO DIFERENCIAL SGB 400-610 E	95,70
099	7307248	SOPORTE PRESOSTATO SGB 400-610 E	13,20
100	7307249	SOPORTE AISLAMIENTO FRONTAL SGB 400-610 E	13,70

**PRODUCTO**  
**CALDERAS DE MEDIA Y GRAN POTENCIA**  
**CALDERAS DE PIE CONDENSACION COMMERCIAL**  
**EUROCONDENS SGB H Y E**  
**EUROCONDENS SGB 400**

**BAXI**

Nº	código	Descripción	Precio €
101	7307250	ABRAZADERA D250 SGB 400-610 E	15,90
102	7307252	TUBO DN250 SGB 400-610 E	311,20
103	7307253	JUNTA D250 SGB 400-610 E	45,00
110	000695398	ABRAZADERA SALIDA HUMOS Ø160 SGB 125-170	15,15
			
110	000695398	ABRAZADERA SALIDA HUMOS Ø160 SGB 125-170	15,15
			
111	7307254	TUBO ENTRADA AIRE 894mm SGB 400-610 E	71,75
			
111	7307254	TUBO ENTRADA AIRE 894mm SGB 400-610 E	71,75
			
111	7307255	TUBO ENTRADA AIRE 1222mm SGB 400-610 E	101,30
			

**PRODUCTO**  
**CALDERAS DE MEDIA Y GRAN POTENCIA**  
**CALDERAS DE PIE CONDENSACION COMMERCIAL**  
**EUROCONDENS SGB H Y E**  
**EUROCONDENS SGB 400**

**BAXI**

	Nº	código	Descripción	Precio €
	112	7307256	CODO ENTRADA AIRE 87° SGB 400-610 E	35,30
	113	7307257	SOPORTE ENTRADA AIRE SGB 400-610 E	21,65
	114	7307258	ADAPTADOR ENTRADA AIRE SGB 400-610 E	91,30
	115	7307259	ENTRADA AIRE SGB 400-610 E	204,95
	116	7307260	VENTURI TYP VMU500 SGB 400-540 E	458,45
	117	7307262	TOMA PRESIÓN R1/8" SGB 400-610 E	9,55
	118	7307263	ADAPTADOR VENTURI-VENTILADOR SGB 400-610 E	102,30
	119	7307264	JUNTA TÓRICA 180X3,5 SGB 400-610 E	12,80

**PRODUCTO**  
**CALDERAS DE MEDIA Y GRAN POTENCIA**  
**CALDERAS DE PIE CONDENSACION COMMERCIAL**  
**EUROCONDENS SGB H Y E**  
**EUROCONDENS SGB 400**

**BAXI**

	Nº	código	Descripción	Precio €
	120	7307265	VENTILADOR TYP G3G250GN4426 SGB 400-610 E	1 727,80
	121	7307266	VÁLVULA ANTIRRETORNO SGB 400-610 E	63,30
	122	7307267	CONEXIÓN QUEMADOR SGB 400-610 E	220,90
	123	7307268	QUEMADOR SGB 400 E	1 717,00
	124	7307272	AISLANTE TAPA QUEMADOR SGB 400-610 E	22,00
	125	7307273	TAPA QUEMADOR SGB 400-610 E	37,05
	126	7307274	JUNTA VENTURI-VÁLVULA DE GAS SGB 400-610 E	14,80
	127	7307275	TUBO DE GAS CONEXIÓN VENTURI SGB 400-610 E	181,30

**PRODUCTO**  
**CALDERAS DE MEDIA Y GRAN POTENCIA**  
**CALDERAS DE PIE CONDENSACION COMMERCIAL**  
**EUROCONDENS SGB H Y E**  
**EUROCONDENS SGB 400**

**BAXI**

Nº	código	Descripción	Precio €
128	000823067	BRIDA RECTA SALIDA VÁLVULA GAS SGB 400-610H	40,85

129	7307276	JUNTA TÓRICA 52X3X5 SGB 400-610 E	7,70
-----	---------	-----------------------------------	------

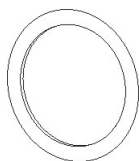

130	7307277	PRESOSTATO DE GAS SGB 400-540 E	65,25
-----	---------	---------------------------------	-------

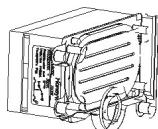

131	7307279	VÁLVULA DE GAS VR434VE5021 SGB 400-540 E	1 041,45
-----	---------	--	----------

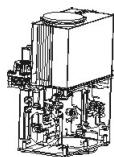

132	7307281	FILTRO DE GAS SGB 400-540 E	46,70
-----	---------	-----------------------------	-------

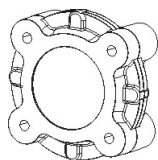

133	000823111	BRIDA RECTA ENTRADA VÁLVULA GAS SGB 400-610H	37,60
-----	-----------	--	-------

134	7307282	TUBO DE GAS CONEXIÓN ENTRADA VÁLVULA SGB 400-540 E	422,80
-----	---------	--	--------

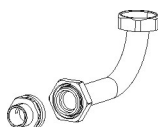

135	7307284	TUBO CONEXIÓN GAS SGB 400-610 E	30,95
-----	---------	---------------------------------	-------



**PRODUCTO**  
**CALDERAS DE MEDIA Y GRAN POTENCIA**  
**CALDERAS DE PIE CONDENSACION COMMERCIAL**  
**EUROCONDENS SGB H Y E**  
**EUROCONDENS SGB 400**

**BAXI**

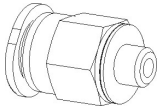
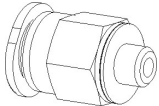
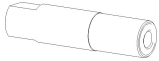
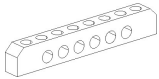
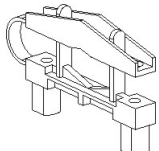
	Nº	código	Descripción	Precio €
	136	7307285	TUBO FLEXIBLE 6X1 SGB 400-610 E	11,05
	137	7307286	CONEXIÓN TUBO FLEXIBLE RECTA M5X6 SGB 400-540 E	13,80
	138	7307286	CONEXIÓN TUBO FLEXIBLE RECTA M5X6 SGB 400-540 E	13,80
	139	7307290	ADAPTADOR 1/8"-M5 SGB 400-540 E	34,80
	145	7637968	TAPA CUADRO CONTROL ISR SGB H	51,55
	146	7715136	PLACA ELECTRÓNICA LMS 14 SGB E/H/I	395,15
	147	7307296	TERMINAL DE TIERRA SGB 400-610 E	12,40
	149	7307297	RETENEDOR DE CABLES SGB 400-610 E	9,90



**PRODUCTO**  
**CALDERAS DE MEDIA Y GRAN POTENCIA**  
**CALDERAS DE PIE CONDENSACION COMMERCIAL**  
**EUROCONDENS SGB H Y E**  
**EUROCONDENS SGB 400**

**BAXI**

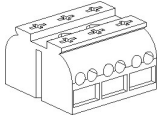
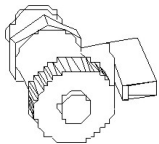
Nº	código	Descripción	Precio €
150	7307298	CONECTOR 3 VÍAS SGB 400-610 E	12,40
			
151	7307299	CARRIL DIN TS35 250mm SGB 400-610 E	13,80
			
221	7503405	CUBIERTA DISPLAY SGB 400-610 E	8,25
701	7307355	TUBO COLECTOR SGB 400-610H	1 047,45
702	000620130	GRIFO DE VACIADO NOVOCONDENS	16,65
			
703	7307356	REDUCCION DN80 a DN65	204,10
703	7307356	REDUCCION DN80 a DN65	204,10
703	7307357	REDUCCION DN80 a DN50 SGB 400-610H	186,65

**PRODUCTO**  
**CALDERAS DE MEDIA Y GRAN POTENCIA**  
**CALDERAS DE PIE CONDENSACION COMMERCIAL**  
**EUROCONDENS SGB H Y E**  
**EUROCONDENS SGB 400**

**BAXI**

Nº	código	Descripción	Precio €
704	7307358	LLAVE CIERRE DN80 SGB 400-610H	495,55
705	7307361	DISTANCIADOR SGB 400H	229,00
706	7307362	BRIDA DN150 SGB 400-610H	106,75
707	7307363	JUNTA DN150 SGB 400-610H	19,35
708	7307365	JUNTA DN80 SGB 400-610H	20,50
709	7307366	JUNTA DN80 SGB 400-610H	12,65
710	7307367	VÁLVULA RETENCION SGB 400-610H	281,35
711	7307368	JUNTA DN50 SGB 400-610H	21,10

**PRODUCTO**  
**CALDERAS DE MEDIA Y GRAN POTENCIA**  
**CALDERAS DE PIE CONDENSACION COMMERCIAL**  
**EUROCONDENS SGB H Y E**  
**EUROCONDENS SGB 400**

**BAXI**

Nº	código	Descripción	Precio €
711	7307369	JUNTA DN65 SGB 400-610H	43,50
711	7307369	JUNTA DN65 SGB 400-610H	43,50
712	7307370	TORNILLO BRIDA SGB 400-610H	17,50
713	7307371	TORNILLO BOMBA SGB 400-610H	18,80
714	7307372	TORNILLO LLAVE CIERRE SGB 400-610H	29,90
715	7307373	TORNILLO BRIDA COLECTOR SGB 400-610H	42,25
716	7307374	TORNILLO LLAVE CIERRE SGB 400-610H	25,90
740	7307375	DISTRIBUIDOR CONEXION SGB 400-610H	370,25

**PRODUCTO**  
**CALDERAS DE MEDIA Y GRAN POTENCIA**  
**CALDERAS DE PIE CONDENSACION COMMERCIAL**  
**EUROCONDENS SGB H Y E**  
**EUROCONDENS SGB 400**

**BAXI**

Nº	código	Descripción	Precio €
741	7307376	SENSOR PRESION MAXIMA SGB 400-610H	749,05
742	7307377	MANÓMETRO 10bar SGB 400-610H	98,30
743	7307378	PURGADOR GRUPO SEGURIDAD SGB 400-610H	35,95
744	7307379	CODO VÁLVULA SEGURIDAD SGB 400-610H	28,00
745	7307380	VÁLVULA SEGURIDAD SGB 400-610H	659,20
760	7307381	FILTRO SGB 400-610H	515,70
761	7307382	CONEXIÓN FILTRO SGB 400-610H	139,90
762	7307256	CODO ENTRADA AIRE 87° SGB 400-610 E	35,30

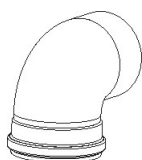

**PRODUCTO**  
**CALDERAS DE MEDIA Y GRAN POTENCIA**  
**CALDERAS DE PIE CONDENSACION COMMERCIAL**  
**EUROCONDENS SGB H Y E**  
**EUROCONDENS SGB 400**

**BAXI**

Nº	código	Descripción	Precio €
763	7307383	SOPORTE FILTRO SGB 400-610H	330,50
764	7307384	JUNTA FILTRO SGB 400-610H	14,55
765	7307385	TUBO EVACUACION HUMOS SGB 400-610H	117,10
780	7309062	TAPA CIEGA Ø350 EUROCONDENS	146,40
781	7309063	TUBO "T" HUMOS DERECHO L=840 SGB 400-610H	430,30
782	7309064	ABRAZADERA D350 SGB 400-610H	54,20
783	7309065	TUBO "T" HUMOS L=600 SGB 400-610H	478,95
784	7309066	TUBO "T" HUMOS IZQUIERDO L=840 SGB 400-610H	409,75

**PRODUCTO**  
**CALDERAS DE MEDIA Y GRAN POTENCIA**  
**CALDERAS DE PIE CONDENSACION COMMERCIAL**  
**EUROCONDENS SGB H Y E**  
**EUROCONDENS SGB 400**

**BAXI**

Nº	código	Descripción	Precio €
785	7309067	TAPA CIEGA CON DESAGÜE SALIDA HUMOS SGB 400-610H	290,35
786	7309068	CONEXIÓN SALIDA HUMOS D260/350 SGB 400-610H	513,30
787	7309069	LINEA DE CONDENSACIÓN SGB 400-610H	267,95
788	000822398	MEDIDOR DE GASES SGB 400-610H	20,35
800	7309072	ENVOLVENTE FILTRO NEOP 600 SGB H	288,00
802	7309074	TAPA MANTENIMIENTO NEOP 600 SGB H	54,25
803	7309075	TAPA CON DIFUSOR NEOP 600 SGB H	82,40
806	7309078	TUBERIA NEOP 600 SGB H	35,90

**PRODUCTO**  
**CALDERAS DE MEDIA Y GRAN POTENCIA**  
**CALDERAS DE PIE CONDENSACION COMMERCIAL**  
**EUROCONDENS SGB H Y E**  
**EUROCONDENS SGB 400**

**BAXI**

Nº	código	Descripción	Precio €
807	7309079	TUBERIA NEOP 30/6000 SGB H	38,10
809	7309709	AUMENTADOR PRESION NEOP 600 SGB H	183,60
810	000677608	MANGUERA AIRE NEOP 300/600 SGB H	28,55
999	7307287	DEFLECTOR SGB 400-610 E	22,90
999	7307300	REMACHE 18mm CON PIES SGB 400-610 E	9,35
999	000681483	CUBIERTA PLACA ELECTRÓNICA SGB 125-300	19,00
999	000635936	FUSIBLE SGB	7,70
999	000681506	CONEXIÓN ENTRADA H5 SGB E	5,75

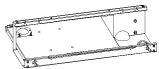

**PRODUCTO**  
**CALDERAS DE MEDIA Y GRAN POTENCIA**  
**CALDERAS DE PIE CONDENSACION COMMERCIAL**  
**EUROCONDENS SGB H Y E**  
**EUROCONDENS SGB 400**

**BAXI**

Nº	código	Descripción	Precio €
999	000681513	CONEXIÓN ENTRADA H4 SGB E	5,75
999	000681520	CONEXIÓN ENTRADA UH SGB E	5,75
999	000681537	CONEXIÓN ENTRADA H1 SGB E	5,75
999	000627498	CONECTOR SONDA EXTERIOR 2 POLOS (ATF)	6,00
999	000671378	CONEXIÓN ENTRADA Bx3 SGB E	5,75
999	000671385	CONEXIÓN ENTRADA Bx2 SGB E	5,75
999	000671392	CONEXIÓN ENTRADA Bx1 SGB E	5,75
999	000688277	CONECTOR RED SGB E	6,00

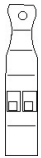



**PRODUCTO**  
**CALDERAS DE MEDIA Y GRAN POTENCIA**  
**CALDERAS DE PIE CONDENSACION COMMERCIAL**  
**EUROCONDENS SGB H Y E**  
**EUROCONDENS SGB 400**

**BAXI**

Nº	código	Descripción	Precio €
999	000644556	CONECTOR BORNE K2	6,70
999	000641371	CONECTOR CIRCULADOR ACS	8,25
999	7307301	CABLEADO SGB 400-610 E	179,80
999	7503404	CABLE BUS 430mm SGB 400-610 E	6,80
999	000695886	CONEXIÓN BUS 570mm SGB E	15,90
999	140040202	QAC 34 SONDA EXT. CON CABLES	27,00
999	000811545	CENTRAL ELECTRÓNICA ESPAÑOL	136,80
999	7307306	SOPORTE DISPLAY SGB 400-610 E	23,30

**PRODUCTO**  
**CALDERAS DE MEDIA Y GRAN POTENCIA**  
**CALDERAS DE PIE CONDENSACION COMMERCIAL**  
**EUROCONDENS SGB H Y E**  
**EUROCONDENS SGB 400**

**BAXI**

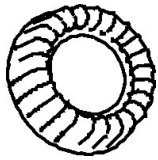

Nº	código	Descripción	Precio €
999	000627436	MANDO GIRATORIO	3,80

999	7503406	CONEXIÓN SERVICIO SGB 400-610 E	2,85
-----	---------	---------------------------------	------

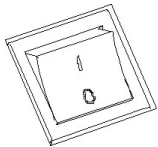

999	000627405	INTERRUPTOR GENERAL	5,65
-----	-----------	---------------------	------



999	000627450	PULSADOR DE BLOQUEO QUEMADOR	6,55
-----	-----------	------------------------------	------

999	7307308	KIT SERVICIO SGB 400 E	179,40
-----	---------	------------------------	--------

999	7307309	CONJUNTO JUNTAS SGB 400-610 E	151,25
-----	---------	-------------------------------	--------

999	7307302	CLIP MASA TRANSFORMADOR ENCENDIDO SGB 400-610 E	11,05
-----	---------	---	-------

999	7503408	TUBO DE SILICONA 5X1,5 Y CONEXIÓN T PARA AIRE SGB 400-610E	9,55
-----	---------	--	------

**PRODUCTO**  
**CALDERAS DE MEDIA Y GRAN POTENCIA**  
**CALDERAS DE PIE CONDENSACION COMMERCIAL**  
**EUROCONDENS SGB H Y E**  
**EUROCONDENS SGB 400**

**BAXI**

Nº	código	Descripción	Precio €
999	7307288	JUNTA TÓRICA 129,8X 3,5 SGB 400-610 E	13,40
999	7218854	TERMOSTATO SEGURIDAD SGB E	49,00
999	7307302	CLIP MASA TRANSFORMADOR ENCENDIDO SGB 400-610 E	11,05
999	7503408	TUBO DE SILICONA 5X1,5 Y CONEXIÓN T PARA AIRE SGB 400-610E	9,55
999	7307309	CONJUNTO JUNTAS SGB 400-610 E	151,25
999	7307308	KIT SERVICIO SGB 400 E	179,40
999	7307300	REMACHE 18mm CON PIES SGB 400-610 E	9,35
999	000681483	CUBIERTA PLACA ELECTRÓNICA SGB 125-300	19,00

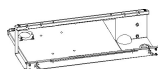

**PRODUCTO**  
**CALDERAS DE MEDIA Y GRAN POTENCIA**  
**CALDERAS DE PIE CONDENSACION COMMERCIAL**  
**EUROCONDENS SGB H Y E**  
**EUROCONDENS SGB 400**

**BAXI**

Nº	código	Descripción	Precio €
999	000635936	FUSIBLE SGB	7,70
999	000681506	CONEXIÓN ENTRADA H5 SGB E	5,75
999	000681513	CONEXIÓN ENTRADA H4 SGB E	5,75
999	000681520	CONEXIÓN ENTRADA UH SGB E	5,75
999	000681537	CONEXIÓN ENTRADA H1 SGB E	5,75
999	000627498	CONECTOR SONDA EXTERIOR 2 POLOS (ATF)	6,00
999	000671378	CONEXIÓN ENTRADA Bx3 SGB E	5,75
999	000671385	CONEXIÓN ENTRADA Bx2 SGB E	5,75

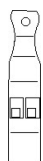

**PRODUCTO**  
**CALDERAS DE MEDIA Y GRAN POTENCIA**  
**CALDERAS DE PIE CONDENSACION COMMERCIAL**  
**EUROCONDENS SGB H Y E**  
**EUROCONDENS SGB 400**

**BAXI**

Nº	código	Descripción	Precio €
999	000671392	CONEXIÓN ENTRADA Bx1 SGB E	5,75
999	000688277	CONECTOR RED SGB E	6,00
999	000644556	CONECTOR BORNE K2	6,70
999	000641371	CONECTOR CIRCULADOR ACS	8,25
999	7714237	CABLEADO SGB 400-610 I	196,00
999	7503404	CABLE BUS 430mm SGB 400-610 E	6,80
999	000695886	CONEXIÓN BUS 570mm SGB E	15,90
999	7306712	LIMITADOR TEMPERATURA SEGURIDAD SGB 400-610 I	75,65

**PRODUCTO**  
**CALDERAS DE MEDIA Y GRAN POTENCIA**  
**CALDERAS DE PIE CONDENSACION COMMERCIAL**  
**EUROCONDENS SGB H Y E**  
**EUROCONDENS SGB 400**

**BAXI**

Nº	código	Descripción	Precio €
999	000811545	CENTRAL ELECTRÓNICA ESPAÑOL	136,80
999	7307306	SOPORTE DISPLAY SGB 400-610 E	23,30
999	7503405	CUBIERTA DISPLAY SGB 400-610 E	8,25
999	7503405	CUBIERTA DISPLAY SGB 400-610 E	8,25
999	000627436	MANDO GIRATORIO	3,80
999	7503406	CONEXIÓN SERVICIO SGB 400-610 E	2,85
999	000627405	INTERRUPTOR GENERAL	5,65
999	000627450	PULSADOR DE BLOQUEO QUEMADOR	6,55

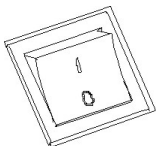
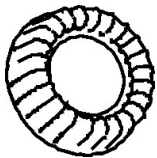

**PRODUCTO**  
**CALDERAS DE MEDIA Y GRAN POTENCIA**  
**CALDERAS DE PIE CONDENSACION COMMERCIAL**  
**EUROCONDENS SGB H Y E**  
**EUROCONDENS SGB 400**

**BAXI**

Nº	código	Descripción	Precio €
999	7307300	REMACHE 18mm CON PIES SGB 400-610 E	9,35
999	000681483	CUBIERTA PLACA ELECTRÓNICA SGB 125-300	19,00
999	000635936	FUSIBLE SGB	7,70
999	000681506	CONEXIÓN ENTRADA H5 SGB E	5,75
999	000681513	CONEXIÓN ENTRADA H4 SGB E	5,75
999	000681520	CONEXIÓN ENTRADA UH SGB E	5,75
999	000681537	CONEXIÓN ENTRADA H1 SGB E	5,75
999	000627498	CONECTOR SONDA EXTERIOR 2 POLOS (ATF)	6,00

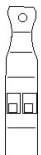
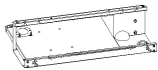

**PRODUCTO**  
**CALDERAS DE MEDIA Y GRAN POTENCIA**  
**CALDERAS DE PIE CONDENSACION COMMERCIAL**  
**EUROCONDENS SGB H Y E**  
**EUROCONDENS SGB 400**

**BAXI**

Nº	código	Descripción	Precio €
999	000671378	CONEXIÓN ENTRADA Bx3 SGB E	5,75
999	000671385	CONEXIÓN ENTRADA Bx2 SGB E	5,75
999	000671392	CONEXIÓN ENTRADA Bx1 SGB E	5,75
999	000688277	CONECTOR RED SGB E	6,00
999	000644556	CONECTOR BORNE K2	6,70
999	000641371	CONECTOR CIRCULADOR ACS	8,25
999	7307301	CABLEADO SGB 400-610 E	179,80
999	000695886	CONEXIÓN BUS 570mm SGB E	15,90



**PRODUCTO**  
**CALDERAS DE MEDIA Y GRAN POTENCIA**  
**CALDERAS DE PIE CONDENSACION COMMERCIAL**  
**EUROCONDENS SGB H Y E**  
**EUROCONDENS SGB 400**

**BAXI**

Nº	código	Descripción	Precio €
999	000811545	CENTRAL ELECTRÓNICA ESPAÑOL	136,80
999	7307306	SOPORTE DISPLAY SGB 400-610 E	23,30
999	000627405	INTERRUPTOR GENERAL	5,65

