

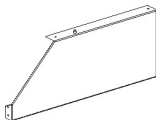

PRODUCTO
CALDERAS DE MEDIA Y GRAN POTENCIA
CALDERAS DE PIE CONDENSACION COMMERCIAL
EUROCONDENS SGB H Y E
EUROCONDENS SGB 540

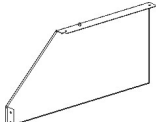

BAXI

222995034 0002 CALDERA EUROCONDENS SGB 540
ESPAÑA

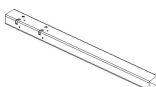
	Nº	código	Descripción	Precio €
	001	7307129	BASE CUERPO SGB 400 E	804,20
	002	7668873	TAPA SUPERIOR CUADRO SGB 400-610 I	68,45
	003	7637970	LATERAL DERECHO CUADRO SGB 400-610H	86,35
	004	7637971	LATERAL IZQUIERDO CUADRO SGB 400-610H	86,35
	005	7307134	SOPORTE INTERNO LARGO CUADRO SGB 400-610 E	51,10
	006	7307135	SOPORTE INTERNO CORTO CUADRO SGB 400-610 E	30,70
	007	7307136	TRAVESAÑO CUADRO DE CONTROL SGB 400-610 E	80,75



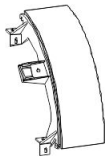
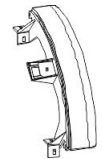
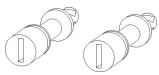

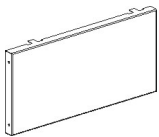
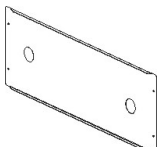
PRODUCTO
CALDERAS DE MEDIA Y GRAN POTENCIA
CALDERAS DE PIE CONDENSACION COMMERCIAL
EUROCONDENS SGB H Y E
EUROCONDENS SGB 540

BAXI

	Nº	código	Descripción	Precio €
	008	7637964	SEPARADOR PANEL LATERAL CUADRO SGB H	14,50
	009	7637963	PANEL LATERAL CUADRO SGB H	14,25
	010	000578899	CIERRE TAPA FRONTAL EAS SSP	4,25
	015	7668830	PANEL FRONTAL SGB 400-610 I	168,25
	016	7310422	LOGOTIPO BAXI	12,40
	017	7637974	LATERAL INFERIOR DELANTERO SGB 470-610H	48,50
	018	7637975	LATERAL INFERIOR TRASERO SGB 400-610H	37,85
	019	7637976	PANEL INFERIOR TRASERO SGB 400-610H	34,15

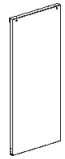
PRODUCTO
CALDERAS DE MEDIA Y GRAN POTENCIA
CALDERAS DE PIE CONDENSACION COMMERCIAL
EUROCONDENS SGB H Y E
EUROCONDENS SGB 540

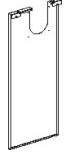
BAXI

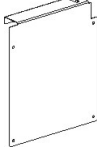
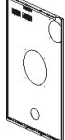
	Nº	código	Descripción	Precio €
	020	7637977	LATERAL IZQUIERDO DELANTERO SGB 400-610H	115,45
	021	7637978	LATERAL DERECHO DELANTERO SGB 400-610H	115,45
	022	7637980	LATERAL SGB 470-610H	118,85
	023	7637980	LATERAL SGB 470-610H	118,85
	024	7637981	LATERAL IZQUIERDO POSTERIOR SGB 400-610H	111,45
	025	7637982	LATERAL DERECHO POSTERIOR SGB 400-610H	107,70
	026	7637983	TAPA ENTRADA DE AIRE LATERAL SGB 400-610H	28,10
	027	7637984	TAPA POSTERIOR SGB 400-610H	152,15

PRODUCTO
CALDERAS DE MEDIA Y GRAN POTENCIA
CALDERAS DE PIE CONDENSACION COMMERCIAL
EUROCONDENS SGB H Y E
EUROCONDENS SGB 540

BAXI

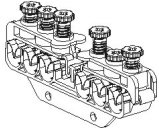
	Nº	código	Descripción	Precio €
	028	7637988	TAPA ENTRADA AIRE POSTERIOR SGB 400-610H	17,25
	029	7637989	TAPA SALIDA DE HUMOS SGB 400-610H	19,85
	030	7307152	PASACABLES SGB 400-610 E	13,50
	031	7637990	SUPLEMENTO ENVOLVENTE SGB 400-610H	22,60
	032	7668878	PANEL SUPERIOR DELANTERO SGB 470-610 I	141,55
	033	7668880	PANEL SUPERIOR INTERMEDIO SGB 470-610 I	141,00
	034	7668881	PANEL SUPERIOR TRASERO SGB 400-610 I	123,10
	040	7307160	BASE CALDERA SGB 470-610 E	1 158,90

PRODUCTO
CALDERAS DE MEDIA Y GRAN POTENCIA
CALDERAS DE PIE CONDENSACION COMMERCIAL
EUROCONDENS SGB H Y E
EUROCONDENS SGB 540

BAXI

Nº	código	Descripción	Precio €
041	7307161	BASE CALDERA FRONTAL SGB 400-610 E	378,65
042	7307162	SOPORTE SGB 400-610 E	13,95
043	7307163	PIE CALDERA SGB 400-610 E	36,85
044	7307165	BANDEJA RECOGIDA CONDENSADOS SGB 470-610 E	370,25
045	7307166	JUNTA BANDEJA RECOGIDA CONDENSADOS SGB 400-610 E	63,20
046	7307167	JUNTA 45X34X3 EPDM SGB 400-610 E	13,20
047	7307168	TUBO CONEXIÓN BANDEJA RECOGIDA CONDENSADOS SGB 400-610 E	23,20
048	7307169	SIFÓN SGB 400-610 E	55,10

PRODUCTO
CALDERAS DE MEDIA Y GRAN POTENCIA
CALDERAS DE PIE CONDENSACION COMMERCIAL
EUROCONDENS SGB H Y E
EUROCONDENS SGB 540

BAXI

Nº	código	Descripción	Precio €
049	7307170	TUBO EVACUACIÓN CONDENSADOS 218mm SGB 400-610 E	20,70
050	7307171	CODO 90º EVACUACIÓN CONDENSADOS SGB 400-610 E	17,50
051	7307172	TUBO EVACUACIÓN CONDENSADOS 400mm SGB 400-610 E	30,80
052	7307173	TUBO EVACUACIÓN CONDENSADOS 1500mm SGB 400-610 E	17,50
053	7307174	FIJACIÓN TUBOS SGB 400-610 E	10,10
054	7307177	ADAPTADOR SALIDA HUMOS SGB 540 E	92,50
055	7307178	JUNTA DN 250 SGB 400-610 E	15,30
056	7307179	TAPÓN REGISTRO LIMPIEZA SGB 400-610 E	18,85

PRODUCTO
CALDERAS DE MEDIA Y GRAN POTENCIA
CALDERAS DE PIE CONDENSACION COMMERCIAL
EUROCONDENS SGB H Y E
EUROCONDENS SGB 540

BAXI

Nº	código	Descripción	Precio €
057	7307180	JUNTA TAPÓN REGISTRO LIMPIEZA SGB 400-610 E	53,45
060	7307181	AISLANTE POSTERIOR SGB 400-610 E	61,20
061	7307182	AISLANTE POSTERIOR FINAL SGB 400-610 E	17,50
062	7307183	AISLANTE POSTERIOR MEDIO SGB 400-610 E	20,10
063	7307184	AISLANTE POSTERIOR INTERIOR SGB 400-610 E	22,00
064	7307185	VARILLA ROSCADA M6X70 SGB 400-610 E	10,00
065	7307188	AISLAMIENTO CUERPO CALDERA SGB 540 E	77,90
066	7307192	SUJECCIÓN AISLANTE SGB 540 E	17,50

PRODUCTO
CALDERAS DE MEDIA Y GRAN POTENCIA
CALDERAS DE PIE CONDENSACION COMMERCIAL
EUROCONDENS SGB H Y E
EUROCONDENS SGB 540

BAXI

Nº	código	Descripción	Precio €
067	7307196	FIJACIÓN AISLANTE SGB 540 E	21,10
068	7307198	FIJACIÓN AISLANTE FRONTAL SGB 400-610 E	24,65
069	7307201	PLACA FIJACIÓN AISLANTE DERECHA SGB 540 E	42,90
070	7307205	PLACA AISLANTE DERECHA SGB 540 E	18,80
071	7307209	REGISTRO LIMPIEZA DERECHO SGB 540 E	117,65
072	7307213	JUNTA REGISTRO LIMPIEZA DERECHO SGB 540 E	130,40
073	7307215	CORDÓN ESTANQUEIDAD REGISTRO SGB 400-610 E	19,75
074	7307216	PLACA AISLAMIENTO FRONTAL SGB 400-610 E	39,40

PRODUCTO
CALDERAS DE MEDIA Y GRAN POTENCIA
CALDERAS DE PIE CONDENSACION COMMERCIAL
EUROCONDENS SGB H Y E
EUROCONDENS SGB 540

BAXI

Nº	código	Descripción	Precio €
075	7307217	PLACA AISLAMIENTO FRONTAL EXTERIOR SGB 400-610 E	16,65
076	7307218	PLACA AISLAMIENTO FRONTAL INTERIOR SGB 400-610 E	17,80
077	7307221	CUERPO CALDERA SGB 540 E	14 995,30
078	7307223	MIRILLA COMPLETA SGB 400-610 E	12,20
079	7307224	CUBIERTA COMPLETA SGB 400-610 E	14,10
080	7307225	JUNTA TÓRICA 105X5 SGB 400-610 E	8,60
081	7307228	TUBO IDA SGB 540 E	732,25
082	000577373	VAINA DE INMERSIÓN	16,65

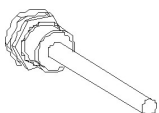

PRODUCTO
CALDERAS DE MEDIA Y GRAN POTENCIA
CALDERAS DE PIE CONDENSACION COMMERCIAL
EUROCONDENS SGB H Y E
EUROCONDENS SGB 540

BAXI

Nº	código	Descripción	Precio €
083	7307229	SONDA SGB 400-610 E	11,15
084	7307230	ELECTRODO DE ENCENDIDO Y SONDA DE IONIZACIÓN SGB 400-610 E	61,05
085	7307231	TAPA POSTERIOR SGB 400-610 E	93,50
086	7307232	JUNTA QUEMADOR/TAPA POSTERIOR SGB 400-610 E	21,45
087	7307233	AISLANTE CÁMARA COMBUSTIÓN SGB 400-610 E	16,55
088	7307234	ABRAZADERA AISLAMIENTO CÁMARA DE COMBUSTIÓN SGB 400-610 E	13,70
090	7307237	COLECTOR IDA SGB 540 E	227,50
091	7307241	TUBO CIEGO SGB 540 E	104,65

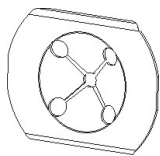
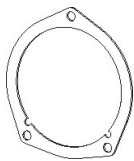

PRODUCTO
CALDERAS DE MEDIA Y GRAN POTENCIA
CALDERAS DE PIE CONDENSACION COMMERCIAL
EUROCONDENS SGB H Y E
EUROCONDENS SGB 540

BAXI

Nº	código	Descripción	Precio €
092	7307243	JUNTA TÓRICA 82X5 SGB 400-610 E	8,50
093	7714236	COLECTOR RETORNO SGB 400-610 I	728,95
094	7308202	PRESOSTATO AGUA SGB I	38,25
095	000695305	LLAVE VACIADO SGB 400-610H	17,25
096	7307245	TRANSFORMADOR DE ENCENDIDO SGB 400-610 E	26,65
097	7307246	PRESOSTATO AIRE SGB 400-610 E	133,00
098	7307247	PRESOSTATO DIFERENCIAL SGB 400-610 E	95,70
099	7307248	SOPORTE PRESOSTATO SGB 400-610 E	13,20

PRODUCTO
CALDERAS DE MEDIA Y GRAN POTENCIA
CALDERAS DE PIE CONDENSACION COMMERCIAL
EUROCONDENS SGB H Y E
EUROCONDENS SGB 540

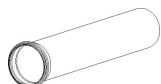
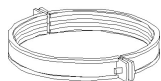
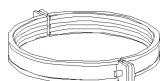

BAXI

Nº	código	Descripción	Precio €
100	7307249	SOPORTE AISLAMIENTO FRONTAL SGB 400-610 E	13,70
101	7307250	ABRAZADERA D250 SGB 400-610 E	15,90
102	7307252	TUBO DN250 SGB 400-610 E	311,20
103	7307253	JUNTA D250 SGB 400-610 E	45,00
110	000695398	ABRAZADERA SALIDA HUMOS Ø160 SGB 125-170	15,15
110	000695398	ABRAZADERA SALIDA HUMOS Ø160 SGB 125-170	15,15
111	7307254	TUBO ENTRADA AIRE 894mm SGB 400-610 E	71,75
111	7307254	TUBO ENTRADA AIRE 894mm SGB 400-610 E	71,75



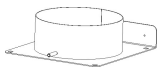
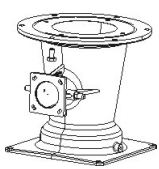

PRODUCTO
CALDERAS DE MEDIA Y GRAN POTENCIA
CALDERAS DE PIE CONDENSACION COMMERCIAL
EUROCONDENS SGB H Y E
EUROCONDENS SGB 540

BAXI

Nº	código	Descripción	Precio €
111	7307255	TUBO ENTRADA AIRE 1222mm SGB 400-610 E	101,30
			
112	7307256	CODO ENTRADA AIRE 87° SGB 400-610 E	35,30
			
113	7307257	SOPORTE ENTRADA AIRE SGB 400-610 E	21,65
			
114	7307258	ADAPTADOR ENTRADA AIRE SGB 400-610 E	91,30
			
115	7307259	ENTRADA AIRE SGB 400-610 E	204,95
			
116	7307260	VENTURI TYP VMU500 SGB 400-540 E	458,45
			
117	7307262	TOMA PRESIÓN R1/8" SGB 400-610 E	9,55
			
118	7307263	ADAPTADOR VENTURI-VENTILADOR SGB 400-610 E	102,30
			

PRODUCTO
CALDERAS DE MEDIA Y GRAN POTENCIA
CALDERAS DE PIE CONDENSACION COMMERCIAL
EUROCONDENS SGB H Y E
EUROCONDENS SGB 540

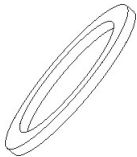
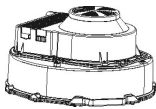
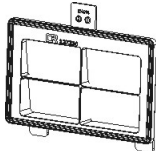
BAXI

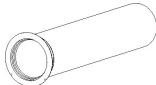
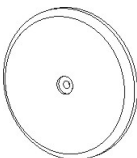
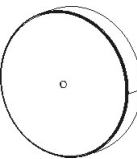
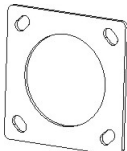
	Nº	código	Descripción	Precio €
	119	7307264	JUNTA TÓRICA 180X3,5 SGB 400-610 E	12,80
	120	7307265	VENTILADOR TYP G3G250GN4426 SGB 400-610 E	1 727,80
	121	7307266	VÁLVULA ANTIRRETORNO SGB 400-610 E	63,30
	122	7307267	CONEXIÓN QUEMADOR SGB 400-610 E	220,90
	123	7307270	QUEMADOR SGB 540 E	1 935,95
	124	7307272	AISLANTE TAPA QUEMADOR SGB 400-610 E	22,00
	125	7307273	TAPA QUEMADOR SGB 400-610 E	37,05
	126	7307274	JUNTA VENTURI-VÁLVULA DE GAS SGB 400-610 E	14,80

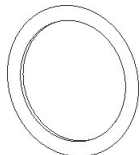
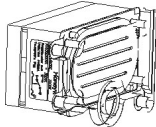
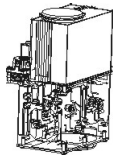
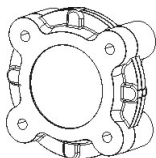
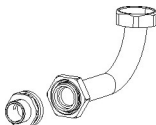

PRODUCTO
CALDERAS DE MEDIA Y GRAN POTENCIA
CALDERAS DE PIE CONDENSACION COMMERCIAL
EUROCONDENS SGB H Y E
EUROCONDENS SGB 540

BAXI

	Nº	código	Descripción	Precio €
	127	7307275	TUBO DE GAS CONEXIÓN VENTURI SGB 400-610 E	181,30
	128	000823067	BRIDA RECTA SALIDA VÁLVULA GAS SGB 400-610H	40,85
	129	7307276	JUNTA TÓRICA 52X3X5 SGB 400-610 E	7,70
	130	7307277	PRESOSTATO DE GAS SGB 400-540 E	65,25
	131	7307279	VÁLVULA DE GAS VR434VE5021 SGB 400-540 E	1 041,45
	132	7307281	FILTRO DE GAS SGB 400-540 E	46,70
	133	000823111	BRIDA RECTA ENTRADA VÁLVULA GAS SGB 400-610H	37,60
	134	7307282	TUBO DE GAS CONEXIÓN ENTRADA VÁLVULA SGB 400-540 E	422,80

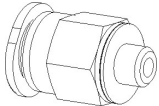
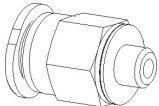
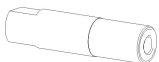
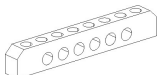

PRODUCTO
CALDERAS DE MEDIA Y GRAN POTENCIA
CALDERAS DE PIE CONDENSACION COMMERCIAL
EUROCONDENS SGB H Y E
EUROCONDENS SGB 540

BAXI

	Nº	código	Descripción	Precio €
	135	7307284	TUBO CONEXIÓN GAS SGB 400-610 E	30,95
	136	7307285	TUBO FLEXIBLE 6X1 SGB 400-610 E	11,05
	137	7307286	CONEXIÓN TUBO FLEXIBLE RECTA M5X6 SGB 400-540 E	13,80
	138	7307286	CONEXIÓN TUBO FLEXIBLE RECTA M5X6 SGB 400-540 E	13,80
	139	7307290	ADAPTADOR 1/8"-M5 SGB 400-540 E	34,80
	145	7637968	TAPA CUADRO CONTROL ISR SGB H	51,55
	146	7715136	PLACA ELECTRÓNICA LMS 14 SGB E/H/I	395,15
	147	7307296	TERMINAL DE TIERRA SGB 400-610 E	12,40

PRODUCTO
CALDERAS DE MEDIA Y GRAN POTENCIA
CALDERAS DE PIE CONDENSACION COMMERCIAL
EUROCONDENS SGB H Y E
EUROCONDENS SGB 540

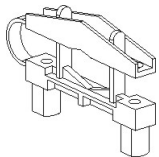
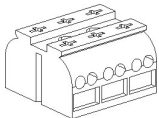
BAXI

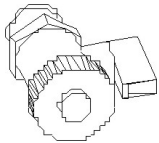
	Nº	código	Descripción	Precio €
	149	7307297	RETENEDOR DE CABLES SGB 400-610 E	9,90
	150	7307298	CONECTOR 3 VÍAS SGB 400-610 E	12,40
	151	7307299	CARRIL DIN TS35 250mm SGB 400-610 E	13,80
	221	7503405	CUBIERTA DISPLAY SGB 400-610 E	8,25
	701	7307355	TUBO COLECTOR SGB 400-610H	1 047,45
	702	000620130	GRIFO DE VACIADO NOVOCONDENS	16,65
	703	7307356	REDUCCION DN80 a DN65	204,10
	703	7307356	REDUCCION DN80 a DN65	204,10

PRODUCTO
CALDERAS DE MEDIA Y GRAN POTENCIA
CALDERAS DE PIE CONDENSACION COMMERCIAL
EUROCONDENS SGB H Y E
EUROCONDENS SGB 540

BAXI

Nº	código	Descripción	Precio €
703	7307357	REDUCCION DN80 a DN50 SGB 400-610H	186,65
704	7307358	LLAVE CIERRE DN80 SGB 400-610H	495,55
705	7307359	DISTANCIADOR SGB 470-540H	231,20
706	7307362	BRIDA DN150 SGB 400-610H	106,75
707	7307363	JUNTA DN150 SGB 400-610H	19,35
708	7307365	JUNTA DN80 SGB 400-610H	20,50
709	7307366	JUNTA DN80 SGB 400-610H	12,65
710	7307367	VÁLVULA RETENCION SGB 400-610H	281,35

PRODUCTO
CALDERAS DE MEDIA Y GRAN POTENCIA
CALDERAS DE PIE CONDENSACION COMMERCIAL
EUROCONDENS SGB H Y E
EUROCONDENS SGB 540

BAXI

Nº	código	Descripción	Precio €
711	7307368	JUNTA DN50 SGB 400-610H	21,10
711	7307369	JUNTA DN65 SGB 400-610H	43,50
711	7307369	JUNTA DN65 SGB 400-610H	43,50
712	7307370	TORNILLO BRIDA SGB 400-610H	17,50
713	7307371	TORNILLO BOMBA SGB 400-610H	18,80
714	7307372	TORNILLO LLAVE CIERRE SGB 400-610H	29,90
715	7307373	TORNILLO BRIDA COLECTOR SGB 400-610H	42,25
716	7307374	TORNILLO LLAVE CIERRE SGB 400-610H	25,90

PRODUCTO
CALDERAS DE MEDIA Y GRAN POTENCIA
CALDERAS DE PIE CONDENSACION COMMERCIAL
EUROCONDENS SGB H Y E
EUROCONDENS SGB 540

BAXI

Nº	código	Descripción	Precio €
740	7307375	DISTRIBUIDOR CONEXION SGB 400-610H	370,25
741	7307376	SENSOR PRESION MAXIMA SGB 400-610H	749,05
742	7307377	MANÓMETRO 10bar SGB 400-610H	98,30
743	7307378	PURGADOR GRUPO SEGURIDAD SGB 400-610H	35,95
744	7307379	CODO VÁLVULA SEGURIDAD SGB 400-610H	28,00
745	7307380	VÁLVULA SEGURIDAD SGB 400-610H	659,20
760	7307381	FILTRO SGB 400-610H	515,70
761	7307382	CONEXIÓN FILTRO SGB 400-610H	139,90

PRODUCTO
CALDERAS DE MEDIA Y GRAN POTENCIA
CALDERAS DE PIE CONDENSACION COMMERCIAL
EUROCONDENS SGB H Y E
EUROCONDENS SGB 540

BAXI

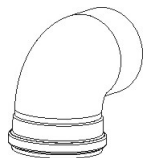

Nº	código	Descripción	Precio €
762	7307256	CODO ENTRADA AIRE 87° SGB 400-610 E	35,30
763	7307383	SOPORTE FILTRO SGB 400-610H	330,50
764	7307384	JUNTA FILTRO SGB 400-610H	14,55
765	7307385	TUBO EVACUACION HUMOS SGB 400-610H	117,10
780	7309062	TAPA CIEGA Ø350 EUROCONDENS	146,40
781	7309063	TUBO "T" HUMOS DERECHO L=840 SGB 400-610H	430,30
782	7309064	ABRAZADERA D350 SGB 400-610H	54,20
783	7309065	TUBO "T" HUMOS L=600 SGB 400-610H	478,95

PRODUCTO
CALDERAS DE MEDIA Y GRAN POTENCIA
CALDERAS DE PIE CONDENSACION COMMERCIAL
EUROCONDENS SGB H Y E
EUROCONDENS SGB 540

BAXI

Nº	código	Descripción	Precio €
784	7309066	TUBO "T" HUMOS IZQUIERDO L=840 SGB 400-610H	409,75
785	7309067	TAPA CIEGA CON DESAGÜE SALIDA HUMOS SGB 400-610H	290,35
786	7309068	CONEXIÓN SALIDA HUMOS D260/350 SGB 400-610H	513,30
787	7309069	LINEA DE CONDENSACIÓN SGB 400-610H	267,95
788	000822398	MEDIDOR DE GASES SGB 400-610H	20,35
800	7309072	ENVOLVENTE FILTRO NEOP 600 SGB H	288,00
802	7309074	TAPA MANTENIMIENTO NEOP 600 SGB H	54,25
803	7309075	TAPA CON DIFUSOR NEOP 600 SGB H	82,40

PRODUCTO
CALDERAS DE MEDIA Y GRAN POTENCIA
CALDERAS DE PIE CONDENSACION COMMERCIAL
EUROCONDENS SGB H Y E
EUROCONDENS SGB 540

BAXI

Nº	código	Descripción	Precio €
806	7309078	TUBERIA NEOP 600 SGB H	35,90
807	7309079	TUBERIA NEOP 30/6000 SGB H	38,10
809	7309709	AUMENTADOR PRESION NEOP 600 SGB H	183,60
810	000677608	MANGUERA AIRE NEOP 300/600 SGB H	28,55
999	7307287	DEFLECTOR SGB 400-610 E	22,90
999	7307300	REMACHE 18mm CON PIES SGB 400-610 E	9,35
999	000681483	CUBIERTA PLACA ELECTRÓNICA SGB 125-300	19,00
999	000635936	FUSIBLE SGB	7,70

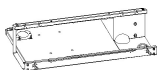

PRODUCTO
CALDERAS DE MEDIA Y GRAN POTENCIA
CALDERAS DE PIE CONDENSACION COMMERCIAL
EUROCONDENS SGB H Y E
EUROCONDENS SGB 540

BAXI

Nº	código	Descripción	Precio €
999	000681506	CONEXIÓN ENTRADA H5 SGB E	5,75
999	000681513	CONEXIÓN ENTRADA H4 SGB E	5,75
999	000681520	CONEXIÓN ENTRADA UH SGB E	5,75
999	000681537	CONEXIÓN ENTRADA H1 SGB E	5,75
999	000627498	CONECTOR SONDA EXTERIOR 2 POLOS (ATF)	6,00
999	000671378	CONEXIÓN ENTRADA Bx3 SGB E	5,75
999	000671385	CONEXIÓN ENTRADA Bx2 SGB E	5,75
999	000671392	CONEXIÓN ENTRADA Bx1 SGB E	5,75

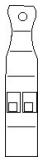

PRODUCTO
CALDERAS DE MEDIA Y GRAN POTENCIA
CALDERAS DE PIE CONDENSACION COMMERCIAL
EUROCONDENS SGB H Y E
EUROCONDENS SGB 540

BAXI

Nº	código	Descripción	Precio €
999	000688277	CONECTOR RED SGB E	6,00
999	000644556	CONECTOR BORNE K2	6,70
999	000641371	CONECTOR CIRCULADOR ACS	8,25
999	7307301	CABLEADO SGB 400-610 E	179,80
999	7503404	CABLE BUS 430mm SGB 400-610 E	6,80
999	000695886	CONEXIÓN BUS 570mm SGB E	15,90
999	140040202	QAC 34 Sonda EXT. CON CABLES	27,00
999	000811545	CENTRAL ELECTRÓNICA ESPAÑOL	136,80

PRODUCTO
CALDERAS DE MEDIA Y GRAN POTENCIA
CALDERAS DE PIE CONDENSACION COMMERCIAL
EUROCONDENS SGB H Y E
EUROCONDENS SGB 540

BAXI

Nº	código	Descripción	Precio €
999	7307306	SOPORTE DISPLAY SGB 400-610 E	23,30
999	000627436	MANDO GIRATORIO	3,80
999	7503406	CONEXIÓN SERVICIO SGB 400-610 E	2,85
999	000627405	INTERRUPTOR GENERAL	5,65
999	000627450	PULSADOR DE BLOQUEO QUEMADOR	6,55
999	7307346	KIT SERVICIO SGB 540 E	219,05
999	7307309	CONJUNTO JUNTAS SGB 400-610 E	151,25
999	7307302	CLIP MASA TRANSFORMADOR ENCENDIDO SGB 400-610 E	11,05

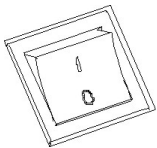
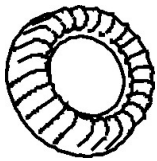

PRODUCTO
CALDERAS DE MEDIA Y GRAN POTENCIA
CALDERAS DE PIE CONDENSACION COMMERCIAL
EUROCONDENS SGB H Y E
EUROCONDENS SGB 540

BAXI

Nº	código	Descripción	Precio €
999	7503408	TUBO DE SILICONA 5X1,5 Y CONEXIÓN T PARA AIRE SGB 400-610E	9,55
999	7307288	JUNTA TÓRICA 129,8X 3,5 SGB 400-610 E	13,40
999	7218854	TERMOSTATO SEGURIDAD SGB E	49,00
999	7307302	CLIP MASA TRANSFORMADOR ENCENDIDO SGB 400-610 E	11,05
999	7503408	TUBO DE SILICONA 5X1,5 Y CONEXIÓN T PARA AIRE SGB 400-610E	9,55
999	7307309	CONJUNTO JUNTAS SGB 400-610 E	151,25
999	7307308	KIT SERVICIO SGB 400 E	179,40
999	7307300	REMACHE 18mm CON PIES SGB 400-610 E	9,35

PRODUCTO
CALDERAS DE MEDIA Y GRAN POTENCIA
CALDERAS DE PIE CONDENSACION COMMERCIAL
EUROCONDENS SGB H Y E
EUROCONDENS SGB 540

BAXI

Nº	código	Descripción	Precio €
999	000681483	CUBIERTA PLACA ELECTRÓNICA SGB 125-300	19,00
			
999	000635936	FUSIBLE SGB	7,70
999	000681506	CONEXIÓN ENTRADA H5 SGB E	5,75
999	000681513	CONEXIÓN ENTRADA H4 SGB E	5,75
999	000681520	CONEXIÓN ENTRADA UH SGB E	5,75
999	000681537	CONEXIÓN ENTRADA H1 SGB E	5,75
999	000627498	CONECTOR SONDA EXTERIOR 2 POLOS (ATF)	6,00
			
999	000671378	CONEXIÓN ENTRADA Bx3 SGB E	5,75

PRODUCTO
CALDERAS DE MEDIA Y GRAN POTENCIA
CALDERAS DE PIE CONDENSACION COMMERCIAL
EUROCONDENS SGB H Y E
EUROCONDENS SGB 540

BAXI

Nº	código	Descripción	Precio €
999	000671385	CONEXIÓN ENTRADA Bx2 SGB E	5,75
999	000671392	CONEXIÓN ENTRADA Bx1 SGB E	5,75
999	000688277	CONECTOR RED SGB E	6,00
999	000644556	CONECTOR BORNE K2	6,70
999	000641371	CONECTOR CIRCULADOR ACS	8,25
999	7714237	CABLEADO SGB 400-610 I	196,00
999	7503404	CABLE BUS 430mm SGB 400-610 E	6,80
999	000695886	CONEXIÓN BUS 570mm SGB E	15,90

PRODUCTO
CALDERAS DE MEDIA Y GRAN POTENCIA
CALDERAS DE PIE CONDENSACION COMMERCIAL
EUROCONDENS SGB H Y E
EUROCONDENS SGB 540

BAXI

Nº	código	Descripción	Precio €
999	7306712	LIMITADOR TEMPERATURA SEGURIDAD SGB 400-610 I	75,65
999	000811545	CENTRAL ELECTRÓNICA ESPAÑOL	136,80
999	7307306	SOPORTE DISPLAY SGB 400-610 E	23,30
999	7503405	CUBIERTA DISPLAY SGB 400-610 E	8,25
999	7503405	CUBIERTA DISPLAY SGB 400-610 E	8,25
999	000627436	MANDO GIRATORIO	3,80
999	7503406	CONEXIÓN SERVICIO SGB 400-610 E	2,85
999	000627405	INTERRUPTOR GENERAL	5,65

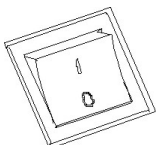
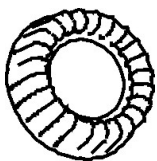

PRODUCTO
CALDERAS DE MEDIA Y GRAN POTENCIA
CALDERAS DE PIE CONDENSACION COMMERCIAL
EUROCONDENS SGB H Y E
EUROCONDENS SGB 540

BAXI

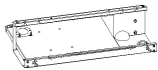

Nº	código	Descripción	Precio €
999	000627450	PULSADOR DE BLOQUEO QUEMADOR	6,55
999	000681483	CUBIERTA PLACA ELECTRÓNICA SGB 125-300	19,00
999	000635936	FUSIBLE SGB	7,70
999	000681506	CONEXIÓN ENTRADA H5 SGB E	5,75
999	000681513	CONEXIÓN ENTRADA H4 SGB E	5,75
999	000681520	CONEXIÓN ENTRADA UH SGB E	5,75
999	000681537	CONEXIÓN ENTRADA H1 SGB E	5,75
999	000627498	CONECTOR SONDA EXTERIOR 2 POLOS (ATF)	6,00

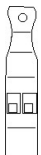

PRODUCTO
CALDERAS DE MEDIA Y GRAN POTENCIA
CALDERAS DE PIE CONDENSACION COMMERCIAL
EUROCONDENS SGB H Y E
EUROCONDENS SGB 540

BAXI

Nº	código	Descripción	Precio €
999	000671378	CONEXIÓN ENTRADA Bx3 SGB E	5,75
999	000671385	CONEXIÓN ENTRADA Bx2 SGB E	5,75
999	000671392	CONEXIÓN ENTRADA Bx1 SGB E	5,75
999	000688277	CONECTOR RED SGB E	6,00
999	000644556	CONECTOR BORNE K2	6,70
999	000641371	CONECTOR CIRCULADOR ACS	8,25
999	7307301	CABLEADO SGB 400-610 E	179,80
999	000695886	CONEXIÓN BUS 570mm SGB E	15,90

PRODUCTO
CALDERAS DE MEDIA Y GRAN POTENCIA
CALDERAS DE PIE CONDENSACION COMMERCIAL
EUROCONDENS SGB H Y E
EUROCONDENS SGB 540

BAXI

Nº	código	Descripción	Precio €
999	000811545	CENTRAL ELECTRÓNICA ESPAÑOL	136,80
999	7307306	SOPORTE DISPLAY SGB 400-610 E	23,30
999	000627405	INTERRUPTOR GENERAL	5,65
999	000627450	PULSADOR DE BLOQUEO QUEMADOR	6,55

