

**PRODUCTO**  
**CALDERAS DE MEDIA Y GRAN POTENCIA**  
**CALDERAS DE PIE CONDENSACION COMMERCIAL**  
**EUROCONDENS SGB H Y E**  
**EUROCONDENS SGB 610**





**BAXI**

**222995035 0000 CALDERA EUROCONDENS SGB 610**  
**ESPAÑA**

	Nº	código	Descripción	Precio €
	<b>001</b>	<b>7307130</b>	BASE CUERPO SGB 470-610 E	752,20
	<b>002</b>	<b>7307131</b>	TAPA SUPERIOR CUADRO DE CONTROL SGB 400-610 E	51,10
	<b>003</b>	<b>7307132</b>	LATERAL DERECHO CUADRO DE CONTROL SGB 400-610 E	59,30
	<b>004</b>	<b>7307133</b>	LATERAL IZQUIERDO CUADRO DE CONTROL SGB 400-610 E	59,30
	<b>005</b>	<b>7307134</b>	SOPORTE INTERNO LARGO CUADRO SGB 400-610 E	51,10
	<b>006</b>	<b>7307135</b>	SOPORTE INTERNO CORTO CUADRO SGB 400-610 E	30,70
	<b>007</b>	<b>7307136</b>	TRAVESAÑO CUADRO DE CONTROL SGB 400-610 E	80,75

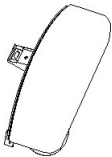
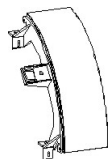



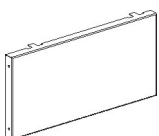
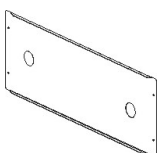

**PRODUCTO**  
**CALDERAS DE MEDIA Y GRAN POTENCIA**  
**CALDERAS DE PIE CONDENSACION COMMERCIAL**  
**EUROCONDENS SGB H Y E**  
**EUROCONDENS SGB 610**

**BAXI**

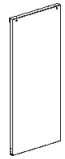
	Nº	código	Descripción	Precio €
	008	000620031	TAPA LATERAL CUADRO CONTROL NOVOCONDENS	18,05
	009	000643276	TAPA CENTRAL LATERAL CUADRO SGB C	56,10
	010	000578899	CIERRE TAPA FRONTAL EAS SSP	4,25
	015	7307137	PUERTA FRONTAL SGB 400-610 E	136,60
	016	7310422	LOGOTIPO BAXI	12,40
	017	7307139	SUPLEMENTO LATERAL INFERIOR DELANTERO SGB 470-610 E	46,70
	018	7307140	SUPLEMENTO LATERAL INFERIOR POSTERIOR SGB 400-610 E	32,15
	019	7307141	SUPLEMENTO POSTERIOR INFERIOR SGB 400-610 E	29,90

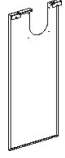

**PRODUCTO**  
**CALDERAS DE MEDIA Y GRAN POTENCIA**  
**CALDERAS DE PIE CONDENSACION COMMERCIAL**  
**EUROCONDENS SGB H Y E**  
**EUROCONDENS SGB 610**

**BAXI**

	Nº	código	Descripción	Precio €
	020	7307142	LATERAL DELANTERO IZQUIERDO SGB 400-610 E	108,95
	021	7307143	LATERAL DELANTERO DERECHO SGB 400-610 E	108,95
	023	7307145	LATERAL SGB 470-610 E	119,10
	024	7307146	LATERAL IZQUIERDO POSTERIOR SGB 400-610 E	102,55
	025	7307147	LATERAL DERECHO POSTERIOR SGB 400-610 E	99,90
	026	7307148	SUPLEMENTO ENTRADA AIRE LATERAL SGB 400-610 E	21,65
	027	7307149	TAPA POSTERIOR SGB 400-610 E	126,15
	028	7307150	SUPLEMENTO ENTRADA AIRE POSTERIOR SGB 400-610 E	13,50

**PRODUCTO**  
**CALDERAS DE MEDIA Y GRAN POTENCIA**  
**CALDERAS DE PIE CONDENSACION COMMERCIAL**  
**EUROCONDENS SGB H Y E**  
**EUROCONDENS SGB 610**

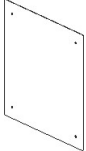
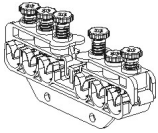
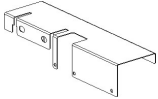
**BAXI**

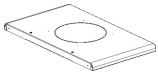
	Nº	código	Descripción	Precio €
	029	7307151	SUPLEMENTO SALIDA HUMOS SGB 400-610 E	17,15
	030	7307152	PASACABLES SGB 400-610 E	13,50
	031	7307153	SUPLEMENTO ENVOLVENTE SGB 400-610 E	17,80
	032	7307155	TAPA SUPERIOR DELANTERA SGB 470-610 E	97,95
	033	7307157	TAPA SUPERIOR INTERMEDIA SGB 470-610 E	97,25
	034	7307158	TAPA SUPERIOR POSERIOR SGB 400-610 E	88,80
	040	7307160	BASE CALDERA SGB 470-610 E	1 158,90
	041	7307161	BASE CALDERA FRONTAL SGB 400-610 E	378,65

**PRODUCTO**  
**CALDERAS DE MEDIA Y GRAN POTENCIA**  
**CALDERAS DE PIE CONDENSACION COMMERCIAL**  
**EUROCONDENS SGB H Y E**  
**EUROCONDENS SGB 610**

**BAXI**

Nº	código	Descripción	Precio €
042	7307162	SOPORTE SGB 400-610 E	13,95
043	7307163	PIE CALDERA SGB 400-610 E	36,85
044	7307165	BANDEJA RECOGIDA CONDENSADOS SGB 470-610 E	370,25
045	7307166	JUNTA BANDEJA RECOGIDA CONDENSADOS SGB 400-610 E	63,20
046	7307167	JUNTA 45X34X3 EPDM SGB 400-610 E	13,20
047	7307168	TUBO CONEXIÓN BANDEJA RECOGIDA CONDENSADOS SGB 400-610 E	23,20
048	7307169	SIFÓN SGB 400-610 E	55,10
049	7307170	TUBO EVACUACIÓN CONDENSADOS 218mm SGB 400-610 E	20,70

**PRODUCTO**  
**CALDERAS DE MEDIA Y GRAN POTENCIA**  
**CALDERAS DE PIE CONDENSACION COMMERCIAL**  
**EUROCONDENS SGB H Y E**  
**EUROCONDENS SGB 610**

**BAXI**

Nº	código	Descripción	Precio €
050	7307171	CODO 90° EVACUACIÓN CONDENSADOS SGB 400-610 E	17,50
051	7307172	TUBO EVACUACIÓN CONDENSADOS 400mm SGB 400-610 E	30,80
052	7307173	TUBO EVACUACIÓN CONDENSADOS 1500mm SGB 400-610 E	17,50
053	7307174	FIJACIÓN TUBOS SGB 400-610 E	10,10
054	7307175	ADAPTADOR SALIDA HUMOS SGB 400/610 E	88,70
055	7307178	JUNTA DN 250 SGB 400-610 E	15,30
056	7307179	TAPÓN REGISTRO LIMPIEZA SGB 400-610 E	18,85
057	7307180	JUNTA TAPÓN REGISTRO LIMPIEZA SGB 400-610 E	53,45

**PRODUCTO**  
**CALDERAS DE MEDIA Y GRAN POTENCIA**  
**CALDERAS DE PIE CONDENSACION COMMERCIAL**  
**EUROCONDENS SGB H Y E**  
**EUROCONDENS SGB 610**

**BAXI**

Nº	código	Descripción	Precio €
060	7307181	AISLANTE POSTERIOR SGB 400-610 E	61,20
061	7307182	AISLANTE POSTERIOR FINAL SGB 400-610 E	17,50
062	7307183	AISLANTE POSTERIOR MEDIO SGB 400-610 E	20,10
063	7307184	AISLANTE POSTERIOR INTERIOR SGB 400-610 E	22,00
064	7307185	VARILLA ROSCADA M6X70 SGB 400-610 E	10,00
065	7307189	AISLAMIENTO CUERPO CALDERA SGB 610 E	83,15
066	7307193	SUJECIÓN AISLANTE SGB 610 E	17,50
067	7307197	FIJACIÓN AISLANTE SGB 610 E	22,00

**PRODUCTO**  
**CALDERAS DE MEDIA Y GRAN POTENCIA**  
**CALDERAS DE PIE CONDENSACION COMMERCIAL**  
**EUROCONDENS SGB H Y E**  
**EUROCONDENS SGB 610**

**BAXI**

Nº	código	Descripción	Precio €
068	7307198	FIJACIÓN AISLANTE FRONTAL SGB 400-610 E	24,65
069	7307202	PLACA FIJACIÓN AISLANTE DERECHA SGB 610 E	45,50
070	7307206	PLACA AISLANTE DERECHA SGB 610 E	19,30
071	7307210	REGISTRO LIMPIEZA DERECHO SGB 610 E	129,50
072	7307214	JUNTA REGISTRO LIMPIEZA DERECHO SGB 610 E	144,50
073	7307215	CORDÓN ESTANQUEIDAD REGISTRO SGB 400-610 E	19,75
074	7307216	PLACA AISLAMIENTO FRONTAL SGB 400-610 E	39,40
075	7307217	PLACA AISLAMIENTO FRONTAL EXTERIOR SGB 400-610 E	16,65



**PRODUCTO**  
**CALDERAS DE MEDIA Y GRAN POTENCIA**  
**CALDERAS DE PIE CONDENSACION COMMERCIAL**  
**EUROCONDENS SGB H Y E**  
**EUROCONDENS SGB 610**

**BAXI**

Nº	código	Descripción	Precio €
076	7307218	PLACA AISLAMIENTO FRONTAL INTERIOR SGB 400-610 E	17,80
077	7307222	CUERPO CALDERA SGB 610 E	16 296,15
078	7307223	MIRILLA COMPLETA SGB 400-610 E	12,20
079	7307224	CUBIERTA COMPLETA SGB 400-610 E	14,10
080	7307225	JUNTA TÓRICA 105X5 SGB 400-610 E	8,60
081	7307226	TUBO IDA SGB 400/610 E	724,00
082	000577373	VAINA DE INMERSIÓN	16,65
083	7307229	SONDA SGB 400-610 E	11,15

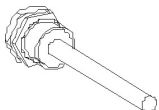

**PRODUCTO**  
**CALDERAS DE MEDIA Y GRAN POTENCIA**  
**CALDERAS DE PIE CONDENSACION COMMERCIAL**  
**EUROCONDENS SGB H Y E**  
**EUROCONDENS SGB 610**

**BAXI**

Nº	código	Descripción	Precio €
084	7307230	ELECTRODO DE ENCENDIDO Y SONDA DE IONIZACIÓN SGB 400-610 E	61,05
085	7307231	TAPA POSTERIOR SGB 400-610 E	93,50
086	7307232	JUNTA QUEMADOR/TAPA POSTERIOR SGB 400-610 E	21,45
087	7307233	AISLANTE CÁMARA COMBUSTIÓN SGB 400-610 E	16,55
088	7307234	ABRAZADERA AISLAMIENTO CÁMARA DE COMBUSTIÓN SGB 400-610 E	13,70
090	7307238	COLECTOR IDA SGB 610 E	231,50
091	7307242	TUBO CIEGO SGB 610 E	111,20
092	7307243	JUNTA TÓRICA 82X5 SGB 400-610 E	8,50

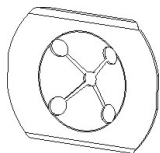
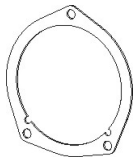

**PRODUCTO**  
**CALDERAS DE MEDIA Y GRAN POTENCIA**  
**CALDERAS DE PIE CONDENSACION COMMERCIAL**  
**EUROCONDENS SGB H Y E**  
**EUROCONDENS SGB 610**

**BAXI**

Nº	código	Descripción	Precio €
093	7307244	TUBO RETORNO SGB 400-610 E	678,45
094	000682234	PRESOSTATO TYP 901.41 SGB 125-300	53,45
095	7503407	LLAVE VACIADO SGB 400-610 E	17,25
096	7307245	TRANSFORMADOR DE ENCENDIDO SGB 400-610 E	26,65
097	7307246	PRESOSTATO AIRE SGB 400-610 E	133,00
098	7307247	PRESOSTATO DIFERENCIAL SGB 400-610 E	95,70
099	7307248	SOPORTE PRESOSTATO SGB 400-610 E	13,20
100	7307249	SOPORTE AISLAMIENTO FRONTAL SGB 400-610 E	13,70

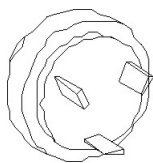

**PRODUCTO**  
**CALDERAS DE MEDIA Y GRAN POTENCIA**  
**CALDERAS DE PIE CONDENSACION COMMERCIAL**  
**EUROCONDENS SGB H Y E**  
**EUROCONDENS SGB 610**

**BAXI**

Nº	código	Descripción	Precio €
101	7307250	ABRAZADERA D250 SGB 400-610 E	15,90
102	7307252	TUBO DN250 SGB 400-610 E	311,20
103	7307253	JUNTA D250 SGB 400-610 E	45,00
110	000695398	ABRAZADERA SALIDA HUMOS Ø160 SGB 125-170	15,15
111	7307254	TUBO ENTRADA AIRE 894mm SGB 400-610 E	71,75
111	7307255	TUBO ENTRADA AIRE 1222mm SGB 400-610 E	101,30
112	7307256	CODO ENTRADA AIRE 87° SGB 400-610 E	35,30
113	7307257	SOPORTE ENTRADA AIRE SGB 400-610 E	21,65

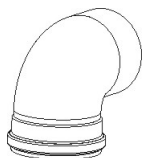
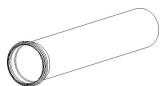
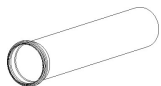



**PRODUCTO**  
**CALDERAS DE MEDIA Y GRAN POTENCIA**  
**CALDERAS DE PIE CONDENSACION COMMERCIAL**  
**EUROCONDENS SGB H Y E**  
**EUROCONDENS SGB 610**

**BAXI**

Nº	código	Descripción	Precio €
114	7307258	ADAPTADOR ENTRADA AIRE SGB 400-610 E	91,30
			
115	7307259	ENTRADA AIRE SGB 400-610 E	204,95
			
116	7307261	VENTURI TYP VMU680 SGB 610 E	524,60
			
117	7307262	TOMA PRESIÓN R1/8" SGB 400-610 E	9,55
			
118	7307263	ADAPTADOR VENTURI-VENTILADOR SGB 400-610 E	102,30
			
119	7307264	JUNTA TÓRICA 180X3,5 SGB 400-610 E	12,80
			
120	7307265	VENTILADOR TYP G3G250GN4426 SGB 400-610 E	1 727,80
			
121	7307266	VÁLVULA ANTIRRETORNO SGB 400-610 E	63,30
			

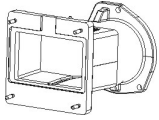
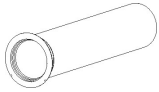
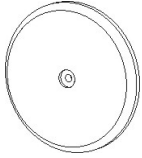
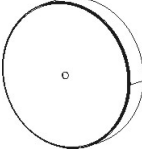
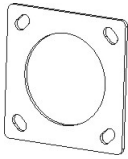

**PRODUCTO**  
**CALDERAS DE MEDIA Y GRAN POTENCIA**  
**CALDERAS DE PIE CONDENSACION COMMERCIAL**  
**EUROCONDENS SGB H Y E**  
**EUROCONDENS SGB 610**

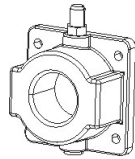
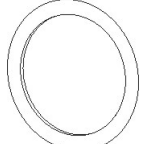
**BAXI**

	Nº	código	Descripción	Precio €
	122	7307267	CONEXIÓN QUEMADOR SGB 400-610 E	220,90
	123	7307271	QUEMADOR SGB 610 E	2 062,40
	124	7307272	AISLANTE TAPA QUEMADOR SGB 400-610 E	22,00
	125	7307273	TAPA QUEMADOR SGB 400-610 E	37,05
	126	7307274	JUNTA VENTURI-VÁLVULA DE GAS SGB 400-610 E	14,80
	127	7307275	TUBO DE GAS CONEXIÓN VENTURI SGB 400-610 E	181,30
	128	7503409	BRIDA RECTA SALIDA VÁLVULA GAS SGB 400-610 E	27,25
	129	7307276	JUNTA TÓRICA 52X3X5 SGB 400-610 E	7,70

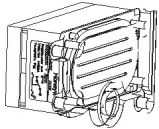
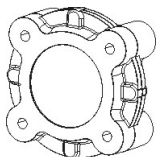
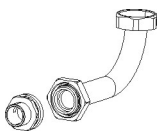

**PRODUCTO**  
**CALDERAS DE MEDIA Y GRAN POTENCIA**  
**CALDERAS DE PIE CONDENSACION COMMERCIAL**  
**EUROCONDENS SGB H Y E**  
**EUROCONDENS SGB 610**

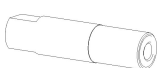
**BAXI**

	Nº	código	Descripción	Precio €
	130	7307278	PRESOSTATO DE GAS SGB 610 E	253,35
	131	7307280	VÁLVULA DE GAS MBC 700-N SGB 610 E	1 506,45
	132	7307281	FILTRO DE GAS SGB 400-540 E	46,70
	133	7503410	BRIDA RECTA ENTRADA VÁLVULA DE GAS SGB 400-610 E	37,95
	134	7307283	TUBO DE GAS CONEXIÓN ENTRADA VÁLVULA SGB 610 E	422,80
	135	7307284	TUBO CONEXIÓN GAS SGB 400-610 E	30,95
	138	7307289	CONEXIÓN TUBO FLEXIBLE 90° M5X6 SGB 610 E	22,40
	139	7307290	ADAPTADOR 1/8"-M5 SGB 400-540 E	34,80

**PRODUCTO**  
**CALDERAS DE MEDIA Y GRAN POTENCIA**  
**CALDERAS DE PIE CONDENSACION COMMERCIAL**  
**EUROCONDENS SGB H Y E**  
**EUROCONDENS SGB 610**

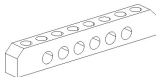
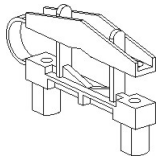
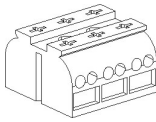
**BAXI**

Nº	código	Descripción	Precio €
145	000620017	TAPA CUADRO CONTROL ISR	39,60
			
146	7715136	PLACA ELECTRÓNICA LMS 14 SGB E/H/I	395,15
147	7307296	TERMINAL DE TIERRA SGB 400-610 E	12,40
			
149	7307297	RETENEDOR DE CABLES SGB 400-610 E	9,90
			
150	7307298	CONECTOR 3 VÍAS SGB 400-610 E	12,40
			
151	7307299	CARRIL DIN TS35 250mm SGB 400-610 E	13,80
			
221	7503405	CUBIERTA DISPLAY SGB 400-610 E	8,25
999	7307285	TUBO FLEXIBLE 6X1 SGB 400-610 E	11,05
			



**PRODUCTO**  
**CALDERAS DE MEDIA Y GRAN POTENCIA**  
**CALDERAS DE PIE CONDENSACION COMMERCIAL**  
**EUROCONDENS SGB H Y E**  
**EUROCONDENS SGB 610**

**BAXI**

Nº	código	Descripción	Precio €
999	7307287	DEFLECTOR SGB 400-610 E	22,90
999	7307300	REMACHE 18mm CON PIES SGB 400-610 E	9,35
999	000681483	CUBIERTA PLACA ELECTRÓNICA SGB 125-300	19,00
999	000635936	FUSIBLE SGB	7,70
999	000681506	CONEXIÓN ENTRADA H5 SGB E	5,75
999	000681513	CONEXIÓN ENTRADA H4 SGB E	5,75
999	000681520	CONEXIÓN ENTRADA UH SGB E	5,75
999	000681537	CONEXIÓN ENTRADA H1 SGB E	5,75

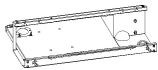

**PRODUCTO**  
**CALDERAS DE MEDIA Y GRAN POTENCIA**  
**CALDERAS DE PIE CONDENSACION COMMERCIAL**  
**EUROCONDENS SGB H Y E**  
**EUROCONDENS SGB 610**

**BAXI**



Nº	código	Descripción	Precio €
999	000627498	CONECTOR SONDA EXTERIOR 2 POLOS (ATF)	6,00
999	000671378	CONEXIÓN ENTRADA Bx3 SGB E	5,75
999	000671385	CONEXIÓN ENTRADA Bx2 SGB E	5,75
999	000671392	CONEXIÓN ENTRADA Bx1 SGB E	5,75
999	000688277	CONECTOR RED SGB E	6,00
999	000644556	CONECTOR BORNE K2	6,70
999	000641371	CONECTOR CIRCULADOR ACS	8,25
999	7307301	CABLEADO SGB 400-610 E	179,80

**PRODUCTO**  
**CALDERAS DE MEDIA Y GRAN POTENCIA**  
**CALDERAS DE PIE CONDENSACION COMMERCIAL**  
**EUROCONDENS SGB H Y E**  
**EUROCONDENS SGB 610**

**BAXI**

Nº	código	Descripción	Precio €
999	7503404	CABLE BUS 430mm SGB 400-610 E	6,80
999	000695886	CONEXIÓN BUS 570mm SGB E	15,90
999	140040202	QAC 34 SONDA EXT. CON CABLES	27,00
999	000811545	CENTRAL ELECTRÓNICA ESPAÑOL	136,80
999	7307306	SOPORTE DISPLAY SGB 400-610 E	23,30
999	000627436	MANDO GIRATORIO	3,80
999	7503406	CONEXIÓN SERVICIO SGB 400-610 E	2,85
999	000627405	INTERRUPTOR GENERAL	5,65

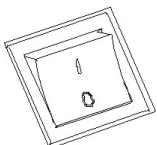
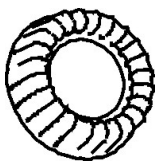

**PRODUCTO**  
**CALDERAS DE MEDIA Y GRAN POTENCIA**  
**CALDERAS DE PIE CONDENSACION COMMERCIAL**  
**EUROCONDENS SGB H Y E**  
**EUROCONDENS SGB 610**

**BAXI**



Nº	código	Descripción	Precio €
999	000627450	PULSADOR DE BLOQUEO QUEMADOR	6,55
999	7307347	KIT SERVICIO SGB 610 E	232,55
999	7307309	CONJUNTO JUNTAS SGB 400-610 E	151,25
999	7307302	CLIP MASA TRANSFORMADOR ENCENDIDO SGB 400-610 E	11,05
999	7503408	TUBO DE SILICONA 5X1,5 Y CONEXIÓN T PARA AIRE SGB 400-610E	9,55
999	7307288	JUNTA TÓRICA 129,8X 3,5 SGB 400-610 E	13,40
999	7218854	TERMOSTATO SEGURIDAD SGB E	49,00