

TABLE OF CONTENTS

Specifications.....	1 - 2
Quick Spec Guide	1 - 3
Clear Opening and Daylight Specifications	1 - 5
General Information	
Multiple Assemblies	1 - 8
Handing and Operation	1 - 9
Elevation Drawing Guide	1 - 10
Elevation Drawings	
17" Units (1-2 sections)	1 - 11
19" Units (1-2-3-4 sections).....	1 - 12
19" Units (5 sections)	1 - 15
21" Units (1-2-3 sections).....	1 - 16
23" Units (1-2-3-4 sections).....	1 - 19
23" Units (5 sections)	1 - 23
25" Units (1 section).....	1 - 24
27" Units (1-2-3-4 sections).....	1 - 27
31" Units (1-2-3 sections).....	1 - 30
31" Units (4 sections)	1 - 33
35" Units (1-2-3 sections).....	1 - 35
36" Units (1-2-3 sections).....	1 - 38
76" Units (3 uneven sections).....	1 - 41
84" Units (3 uneven sections).....	1 - 42
92" Units (3 uneven sections).....	1 - 43
100" Units (3 uneven sections).....	1 - 44
108" Units (3 uneven sections).....	1 - 45
116" Units (3 uneven sections).....	1 - 47
124" Units (3 uneven sections).....	1 - 49
76" Units (30° Bay)	1 - 50
84" Units (30° Bay)	1 - 51
92" Units (30° Bay)	1 - 52
100" Units (30° Bay)	1 - 53
108" Units (30° Bay)	1 - 54
116" Units (30° Bay)	1 - 56
76" Units (45° Bay)	1 - 58
84" Units (45° Bay)	1 - 59
92" Units (45° Bay)	1 - 60
100" Units (45° Bay)	1 - 61
108" Units (45° Bay)	1 - 62
116" Units (45° Bay)	1 - 64
Detail Drawings	
Glazing Options - Intenal Grilles - Tripane	1 - 66
Glazing Options - Intenal Grilles - Dualpane.....	1 - 67
Glazing Options - Simulated Divided Lites & False Mullions - Tripane	1 - 68
Glazing Options - Simulated Divided Lites & False Mullions - Dualpane.....	1 - 69
Jamb Extension Options - Aluminum	1 - 70
Jamb Extension Options - Wood.....	1 - 71
Mullion Details.....	1 - 72
Trim Options - Flush Frame with and without Flange	1 - 73
Trim Options - 1 1/2" Brickmould with and without Flange	1 - 74
Trim Options - 3 1/2" Brickmould with and without Flange	1 - 75
90° Corner Mullion.....	1 - 76

SPECIFICATIONS

MATERIAL

The vinyl and extruded aluminum window profiles meet the AAMA 303-97 performance requirements.

WINDOW FRAME

Vinyl:

All frames are assembled using a fusion welding technology for strength and durability. The depth of the frame is 3 1/4" (83 mm), and the thickness of the outer wall 0.065 inch. The frames are provided with groove for attaching external moldings and come with a built-in adaptor for 1/2-3/4 inch. Closed frame version is also available for replacement.

Aluminum:

The frame cladding is made of extruded aluminum and coated with a baked paint. A nailing fin is integrated into the frame for superior sealing. The mechanical connection with corner injection provides good rigidity and allows application of sealant. The double seal provides optimum sealing.

SASH

Vinyl:

The sash has a thickness of 2 1/4" (nominal) or (54.61 mm), it is assembled using a fusion welding technology for strength and durability.

Aluminum:

The aluminum sash cladding is screwed for easy replacement of parts. Limited points of contact between aluminum and pvc minimize thermal transmittance. The mechanical assembly with double corners on all 4 corners results in a very strong sash.

GLAZING

Sealed unit, 3/4" (19 mm) consists of two panes of glass sealed around an interlayer insulation with double sealing. All insulating glass meet the performance requirements of the standard under IGMAC CAN/CGSB-12.8-97.

GLAZING OPTIONS

The Sealed unit, 3/4 in. (19 mm) is available in clear glass, low-emissivity (low-E) with Argon, tinted or frosted, or any other type of architectural glass upon request. All glasses are available tempered. Sealed unit up to 7/8" is available in option also is a triple glass of 1 1/4" sealed unit.

WEATHERSTRIPPING

Weatherstripping with fin brush is applied around the perimeter of the sash. The double row of weatherstripping coextruded meets AAMA 701 or AAMA 702. A weatherstrip is applied to the entire perimeter of the frame.

HARDWARE

Awning windows have a double lever operator with anticorrosion coating and a multipoint locking system. The finish of the operators is a hardware brand offered by Truth with a folding handle.

WINDOW SCREEN

The insect screen is made in fiberglass (tread 18 x 16) installed in a folded aluminum painted frame, adjusted within the window. The screens are designed to bring air and light while keeping insects out, not to prevent a person or object falling through an open window. For more information on screens or other security devices, contact your retailer of building materials locally.

GRILLES

Simulated divided lite (SDL) made of vinyl inside and outside aluminum, 7/8 in. (23 mm) and 1 3/8 (35 mm) or SDL vinyl inside and aluminum outside 2 5/16 inch (59 mm) fixed permanently on each side of the insulating pane with or without spacer between the glass panes.

Sealed grilles (grilles between the glass) - Georgian style, tubular, square or flat mounted between the glass panes suspended within the empty space.

INSTALLATION

Install vinyl windows in accordance with JELD-WEN installation method. Visit www.jeld-wen.com/resources for instructions.

PERFORMANCE

CSA certified - classified and labeled in accordance with CSA certification program NFRC Certified - (classified and labeled in accordance with NFRC certification program). EnergyStar certified - (classified and labeled according to EnergyStar certification program).

QUICK SPEC GUIDE

SPECIFICATIONS	STANDARD FEATURES	OPTIONAL FEATURES
Colour	<ul style="list-style-type: none"> • White • Black • Commercial Brown • Pebble • Slate 	DF Colour Chart
Module Dimension	<ul style="list-style-type: none"> • Width: 22" to 60" • Height: 23" to 42" 	The modules can be mull together to a maximum of 60sq/ft. All dimensions including the minimum and maximum parameters.
Frame	<ul style="list-style-type: none"> • Exterior Groove • 1/2"-3/4" Integrated Adaptor • Mechanical assembly with injections corners 	
Exterior Moulding	<ul style="list-style-type: none"> • Exterior Groove • 1 1/2" Moulding with or without nailing fin • 3 1/2" Moulding with or without nailing fin 	
Glazing	<ul style="list-style-type: none"> • Clear glazing with insulating spacer 	<ul style="list-style-type: none"> - Triple pane - Low emissivity with argon gas - Frosted - Bronze - Grey - Glue chip - Satin - Laminated - All glasses are available tempered
Hardware	<ul style="list-style-type: none"> • Double lever operator • Multi-point locking system • Truth Encore folding handle 	
Hardware Colour	<ul style="list-style-type: none"> • White (device is visible when window is closed) 	
Screen	<ul style="list-style-type: none"> • Fibreglass mesh 	
Colour of Screen Frame	<ul style="list-style-type: none"> • White 	
Grilles		<ul style="list-style-type: none"> - Simulated divided lite (SDL) of 7/8" and 1 3/8" with or without spacer bar - False mullion of 2 5/16" with or without spacer bar Georgian sealed grilles <ul style="list-style-type: none"> - White - Commercial Brown/White - Pebble/White - Slate/White - Black/White - Other colours available upon request Tubular sealed grilles <ul style="list-style-type: none"> - White - Brass - Grey - Pewter

QUICK SPEC GUIDE CONT'D

SPECIFICATIONS	STANDARD FEATURES	OPTIONAL FEATURES
Grilles cont'd		Square sealed grilles - White - Brass - Grey - Pewter Flat sealed grilles - White - Other colours available in duo/white
Frame depth	<ul style="list-style-type: none"> • 4 9/16" behind nailing fin. Overall frame depth of 5 13/16" 	- Closed or opened interior frame - Interior vinyl clad frame extension

CLEAR OPENING AND DAYLIGHT SPECIFICATIONS

Unit No.	Clear opening		Clear opening				Daylight Opening		Length of wetherstrip		Unit	
	Sq. Ft	Sq. met.	Width		Height		Sq. Ft	Sq. met.	lin. Ft	lin. met.	Sq. Ft	Sq. met.
			inch	mm	inch	mm						
VK1T 017 022	0,98	0,09	8,2	208	17,3	438	1,2	0,11	5,7	1,7	2,6	0,24
VK1T 017 026	1,21	0,11	8,2	208	21,3	540	1,4	0,13	6,3	1,9	3,1	0,29
VK1T 017 030	1,44	0,13	8,2	208	25,3	641	1,7	0,16	7,0	2,1	3,5	0,33
VK1T 017 034	1,66	0,15	8,2	208	29,3	743	2,0	0,19	7,7	2,3	4,0	0,37
VK1T 017 036	1,78	0,17	8,2	208	31,3	794	2,2	0,20	8,0	2,4	4,3	0,39
VK1T 017 038	1,89	0,18	8,2	208	33,3	845	2,3	0,22	8,3	2,5	4,5	0,42
VK1T 017 042	2,12	0,20	8,2	208	37,3	946	2,6	0,24	9,0	2,7	5,0	0,46
VK1T 017 046	2,35	0,22	8,2	208	41,3	1048	2,9	0,27	9,7	2,9	5,4	0,50
VK1T 017 048	2,46	0,23	8,2	208	43,3	1099	3,1	0,29	10,0	3,0	5,7	0,53
VK1T 017 050	2,57	0,24	8,2	208	45,3	1149	3,2	0,30	10,3	3,1	5,9	0,55
VK1T 017 054	2,80	0,26	8,2	208	49,3	1251	3,5	0,33	11,0	3,4	6,4	0,59
VK1T 017 058	3,03	0,28	8,2	208	53,3	1353	3,8	0,35	11,7	3,6	6,8	0,64
VK1T 017 060	3,14	0,29	8,2	208	55,3	1403	4,0	0,37	12,0	3,7	7,1	0,66
VK1T 017 062	3,26	0,30	8,2	208	57,3	1454	4,1	0,38	12,3	3,8	7,3	0,68
VK1T 017 066	3,48	0,32	8,2	208	61,3	1556	4,4	0,41	13,0	4,0	7,8	0,72
VK1T 017 070	3,71	0,34	8,2	208	65,3	1657	4,7	0,44	13,7	4,2	8,3	0,77
VK1T 017 074	3,94	0,37	8,2	208	69,3	1759	5,0	0,46	14,3	4,4	8,7	0,81
VK1T 017 078	4,16	0,39	8,2	208	73,3	1861	5,3	0,49	15,0	4,6	9,2	0,86
VK1T 019 022	1,22	0,11	10,2	259	17,3	438	1,4	0,13	6,0	1,8	2,9	0,27
VK1T 019 026	1,50	0,14	10,2	259	21,3	540	1,7	0,16	6,7	2,0	3,4	0,32
VK1T 019 030	1,79	0,17	10,2	259	25,3	641	2,1	0,19	7,3	2,2	4,0	0,37
VK1T 019 034	2,07	0,19	10,2	259	29,3	743	2,4	0,22	8,0	2,4	4,5	0,42
VK1T 019 036	2,21	0,21	10,2	259	31,3	794	2,6	0,24	8,3	2,5	4,8	0,44
VK1T 019 038	2,35	0,22	10,2	259	33,3	845	2,8	0,26	8,7	2,6	5,0	0,47
VK1T 019 042	2,64	0,24	10,2	259	37,3	946	3,1	0,29	9,3	2,8	5,5	0,51
VK1T 019 046	2,92	0,27	10,2	259	41,3	1048	3,5	0,32	10,0	3,0	6,1	0,56
VK1T 019 048	3,06	0,28	10,2	259	43,3	1099	3,6	0,34	10,3	3,1	6,3	0,59
VK1T 019 050	3,20	0,30	10,2	259	45,3	1149	3,8	0,36	10,7	3,2	6,6	0,61
VK1T 019 054	3,48	0,32	10,2	259	49,3	1251	4,2	0,39	11,3	3,5	7,1	0,66
VK1T 019 058	3,77	0,35	10,2	259	53,3	1353	4,5	0,42	12,0	3,7	7,7	0,71
VK1T 019 060	3,91	0,36	10,2	259	55,3	1403	4,7	0,44	12,3	3,8	7,9	0,74
VK1T 019 062	4,05	0,38	10,2	259	57,3	1454	4,9	0,45	12,7	3,9	8,2	0,76
VK1T 019 066	4,33	0,40	10,2	259	61,3	1556	5,2	0,49	13,3	4,1	8,7	0,81
VK1T 019 070	4,62	0,43	10,2	259	65,3	1657	5,6	0,52	14,0	4,3	9,2	0,86
VK1T 019 074	4,90	0,46	10,2	259	69,3	1759	5,9	0,55	14,7	4,5	9,8	0,91
VK1T 019 078	5,18	0,48	10,2	259	73,3	1861	6,3	0,58	15,3	4,7	10,3	0,96
VK1T 021 022	1,46	0,14	12,2	310	17,3	438	1,6	0,15	6,3	1,9	3,2	0,30
VK1T 021 026	1,80	0,17	12,2	310	21,3	540	2,0	0,19	7,0	2,1	3,8	0,35
VK1T 021 030	2,14	0,20	12,2	310	25,3	641	2,4	0,22	7,7	2,3	4,4	0,41
VK1T 021 034	2,48	0,23	12,2	310	29,3	743	2,8	0,26	8,3	2,5	5,0	0,46
VK1T 021 036	2,64	0,25	12,2	310	31,3	794	3,0	0,28	8,7	2,6	5,3	0,49
VK1T 021 038	2,81	0,26	12,2	310	33,3	845	3,2	0,30	9,0	2,7	5,5	0,51
VK1T 021 042	3,15	0,29	12,2	310	37,3	946	3,6	0,34	9,7	2,9	6,1	0,57
VK1T 021 046	3,49	0,32	12,2	310	41,3	1048	4,0	0,37	10,3	3,1	6,7	0,62
VK1T 021 048	3,66	0,34	12,2	310	43,3	1099	4,2	0,39	10,7	3,2	7,0	0,65
VK1T 021 050	3,83	0,36	12,2	310	45,3	1149	4,4	0,41	11,0	3,4	7,3	0,68
VK1T 021 054	4,17	0,39	12,2	310	49,3	1251	4,8	0,45	11,7	3,6	7,9	0,73
VK1T 021 058	4,51	0,42	12,2	310	53,3	1353	5,2	0,49	12,3	3,8	8,5	0,79
VK1T 021 060	4,68	0,43	12,2	310	55,3	1403	5,4	0,51	12,7	3,9	8,8	0,81
VK1T 021 062	4,85	0,45	12,2	310	57,3	1454	5,6	0,52	13,0	4,0	9,0	0,84
VK1T 021 066	5,18	0,48	12,2	310	61,3	1556	6,1	0,56	13,7	4,2	9,6	0,89
VK1T 021 070	5,52	0,51	12,2	310	65,3	1657	6,5	0,60	14,3	4,4	10,2	0,95
VK1T 021 074	5,86	0,54	12,2	310	69,3	1759	6,9	0,64	15,0	4,6	10,8	1,00
VK1T 021 078	6,20	0,58	12,2	310	73,3	1861	7,3	0,68	15,7	4,8	11,4	1,06

CLEAR OPENING AND DAYLIGHT SPECIFICATIONS cont'd

Unit No.	Clear opening		Clear opening				Daylight Opening		Length of wetherstrip		Unit	
	Sq. Ft	Sq. met.	Width		Height		Sq. Ft	Sq. met.	lin. Ft	lin. met.	Sq. Ft	Sq. met.
			inch	mm	inch	mm						
VK1T 023 022	1,70	0,16	14,2	360	17,3	438	1,8	0,17	6,7	2,0	3,5	0,33
VK1T 023 026	2,09	0,19	14,2	360	21,3	540	2,3	0,21	7,3	2,2	4,2	0,39
VK1T 023 030	2,49	0,23	14,2	360	25,3	641	2,7	0,25	8,0	2,4	4,8	0,45
VK1T 023 034	2,88	0,27	14,2	360	29,3	743	3,2	0,30	8,7	2,6	5,4	0,50
VK1T 023 036	3,08	0,29	14,2	360	31,3	794	3,4	0,32	9,0	2,7	5,8	0,53
VK1T 023 038	3,28	0,30	14,2	360	33,3	845	3,7	0,34	9,3	2,8	6,1	0,56
VK1T 023 042	3,67	0,34	14,2	360	37,3	946	4,1	0,38	10,0	3,0	6,7	0,62
VK1T 023 046	4,06	0,38	14,2	360	41,3	1048	4,6	0,42	10,7	3,2	7,3	0,68
VK1T 023 048	4,26	0,40	14,2	360	43,3	1099	4,8	0,45	11,0	3,4	7,7	0,71
VK1T 023 050	4,46	0,41	14,2	360	45,3	1149	5,0	0,47	11,3	3,5	8,0	0,74
VK1T 023 054	4,85	0,45	14,2	360	49,3	1251	5,5	0,51	12,0	3,7	8,6	0,80
VK1T 023 058	5,25	0,49	14,2	360	53,3	1353	6,0	0,55	12,7	3,9	9,3	0,86
VK1T 023 060	5,44	0,51	14,2	360	55,3	1403	6,2	0,58	13,0	4,0	9,6	0,89
VK1T 023 062	5,64	0,52	14,2	360	57,3	1454	6,4	0,60	13,3	4,1	9,9	0,92
VK1T 023 066	6,03	0,56	14,2	360	61,3	1556	6,9	0,64	14,0	4,3	10,5	0,98
VK1T 023 070	6,43	0,60	14,2	360	65,3	1657	7,3	0,68	14,7	4,5	11,2	1,04
VK1T 023 074	6,82	0,63	14,2	360	69,3	1759	7,8	0,73	15,3	4,7	11,8	1,10
VK1T 023 078	7,22	0,67	14,2	360	73,3	1861	8,3	0,77	16,0	4,9	12,5	1,16
VK1T 025 022	1,94	0,18	16,2	411	17,3	438	2,0	0,19	7,0	2,1	3,8	0,35
VK1T 025 026	2,39	0,22	16,2	411	21,3	540	2,5	0,24	7,7	2,3	4,5	0,42
VK1T 025 030	2,84	0,26	16,2	411	25,3	641	3,1	0,28	8,3	2,5	5,2	0,48
VK1T 025 034	3,29	0,31	16,2	411	29,3	743	3,6	0,33	9,0	2,7	5,9	0,55
VK1T 025 036	3,51	0,33	16,2	411	31,3	794	3,8	0,36	9,3	2,8	6,3	0,58
VK1T 025 038	3,74	0,35	16,2	411	33,3	845	4,1	0,38	9,7	2,9	6,6	0,61
VK1T 025 042	4,19	0,39	16,2	411	37,3	946	4,6	0,43	10,3	3,1	7,3	0,68
VK1T 025 046	4,64	0,43	16,2	411	41,3	1048	5,1	0,48	11,0	3,4	8,0	0,74
VK1T 025 048	4,86	0,45	16,2	411	43,3	1099	5,4	0,50	11,3	3,5	8,3	0,77
VK1T 025 050	5,09	0,47	16,2	411	45,3	1149	5,6	0,52	11,7	3,6	8,7	0,81
VK1T 025 054	5,54	0,51	16,2	411	49,3	1251	6,2	0,57	12,3	3,8	9,4	0,87
VK1T 025 058	5,99	0,56	16,2	411	53,3	1353	6,7	0,62	13,0	4,0	10,1	0,94
VK1T 025 060	6,21	0,58	16,2	411	55,3	1403	6,9	0,64	13,3	4,1	10,4	0,97
VK1T 025 062	6,44	0,60	16,2	411	57,3	1454	7,2	0,67	13,7	4,2	10,8	1,00
VK1T 025 066	6,89	0,64	16,2	411	61,3	1556	7,7	0,72	14,3	4,4	11,5	1,06
VK1T 025 070	7,33	0,68	16,2	411	65,3	1657	8,2	0,76	15,0	4,6	12,2	1,13
VK1T 025 074	7,78	0,72	16,2	411	69,3	1759	8,7	0,81	15,7	4,8	12,8	1,19
VK1T 025 078	8,23	0,76	16,2	411	73,3	1861	9,3	0,86	16,3	5,0	13,5	1,26
VK1T 027 022	2,18	0,20	18,2	462	17,3	438	2,2	0,21	7,3	2,2	4,1	0,38
VK1T 027 026	2,68	0,25	18,2	462	21,3	540	2,8	0,26	8,0	2,4	4,9	0,45
VK1T 027 030	3,19	0,30	18,2	462	25,3	641	3,4	0,31	8,7	2,6	5,6	0,52
VK1T 027 034	3,69	0,34	18,2	462	29,3	743	4,0	0,37	9,3	2,8	6,4	0,59
VK1T 027 036	3,95	0,37	18,2	462	31,3	794	4,2	0,39	9,7	2,9	6,8	0,63
VK1T 027 038	4,20	0,39	18,2	462	33,3	845	4,5	0,42	10,0	3,0	7,1	0,66
VK1T 027 042	4,70	0,44	18,2	462	37,3	946	5,1	0,47	10,7	3,2	7,9	0,73
VK1T 027 046	5,21	0,48	18,2	462	41,3	1048	5,7	0,53	11,3	3,5	8,6	0,80
VK1T 027 048	5,46	0,51	18,2	462	43,3	1099	6,0	0,55	11,7	3,6	9,0	0,84
VK1T 027 050	5,72	0,53	18,2	462	45,3	1149	6,2	0,58	12,0	3,7	9,4	0,87
VK1T 027 054	6,22	0,58	18,2	462	49,3	1251	6,8	0,63	12,7	3,9	10,1	0,94
VK1T 027 058	6,73	0,62	18,2	462	53,3	1353	7,4	0,69	13,3	4,1	10,9	1,01
VK1T 027 060	6,98	0,65	18,2	462	55,3	1403	7,7	0,71	13,7	4,2	11,3	1,05
VK1T 027 062	7,23	0,67	18,2	462	57,3	1454	8,0	0,74	14,0	4,3	11,6	1,08
VK1T 027 066	7,74	0,72	18,2	462	61,3	1556	8,5	0,79	14,7	4,5	12,4	1,15
VK1T 027 070	8,24	0,77	18,2	462	65,3	1657	9,1	0,85	15,3	4,7	13,1	1,22
VK1T 027 074	8,75	0,81	18,2	462	69,3	1759	9,7	0,90	16,0	4,9	13,9	1,29
VK1T 027 078	9,25	0,86	18,2	462	73,3	1861	10,3	0,95	16,7	5,1	14,6	1,36

CLEAR OPENING AND DAYLIGHT SPECIFICATIONS cont'd

Unit No.	Clear opening		Clear opening				Daylight Opening		Length of wetherstrip		Unit	
	Sq. Ft	Sq. met.	Width		Height		Sq. Ft	Sq. met.	lin. Ft	lin. met.	Sq. Ft	Sq. met.
			inch	mm	inch	mm						
VK1T 031 022	2,66	0,25	22,2	564	17,3	438	2,7	0,25	8,0	2,4	4,7	0,44
VK1T 031 026	3,27	0,30	22,2	564	21,3	540	3,4	0,31	8,7	2,6	5,6	0,52
VK1T 031 030	3,89	0,36	22,2	564	25,3	641	4,0	0,38	9,3	2,8	6,5	0,60
VK1T 031 034	4,51	0,42	22,2	564	29,3	743	4,7	0,44	10,0	3,0	7,3	0,68
VK1T 031 036	4,81	0,45	22,2	564	31,3	794	5,1	0,47	10,3	3,1	7,8	0,72
VK1T 031 038	5,12	0,48	22,2	564	33,3	845	5,4	0,50	10,7	3,2	8,2	0,76
VK1T 031 042	5,74	0,53	22,2	564	37,3	946	6,1	0,57	11,3	3,5	9,0	0,84
VK1T 031 046	6,36	0,59	22,2	564	41,3	1048	6,8	0,63	12,0	3,7	9,9	0,92
VK1T 031 048	6,66	0,62	22,2	564	43,3	1099	7,1	0,66	12,3	3,8	10,3	0,96
VK1T 031 050	6,97	0,65	22,2	564	45,3	1149	7,5	0,69	12,7	3,9	10,8	1,00
VK1T 031 054	7,59	0,70	22,2	564	49,3	1251	8,1	0,76	13,3	4,1	11,6	1,08
VK1T 031 058	8,20	0,76	22,2	564	53,3	1353	8,8	0,82	14,0	4,3	12,5	1,16
VK1T 031 060	8,51	0,79	22,2	564	55,3	1403	9,2	0,85	14,3	4,4	12,9	1,20
VK1T 031 062	8,82	0,82	22,2	564	57,3	1454	9,5	0,88	14,7	4,5	13,3	1,24
VK1T 031 066	9,44	0,88	22,2	564	61,3	1556	10,2	0,95	15,3	4,7	14,2	1,32
VK1T 031 070	10,05	0,93	22,2	564	65,3	1657	10,9	1,01	16,0	4,9	15,1	1,40
VK1T 031 074	10,67	0,99	22,2	564	69,3	1759	11,6	1,07	16,7	5,1	15,9	1,48
VK1T 031 078	-	-	-	-	-	-	-	-	-	-	-	-
VK1T 035 022	3,14	0,29	26,2	665	17,3	438	3,1	0,29	8,7	2,6	5,3	0,50
VK1T 035 026	3,86	0,36	26,2	665	21,3	540	3,9	0,36	9,3	2,8	6,3	0,59
VK1T 035 030	4,59	0,43	26,2	665	25,3	641	4,7	0,44	10,0	3,0	7,3	0,68
VK1T 035 034	5,32	0,49	26,2	665	29,3	743	5,5	0,51	10,7	3,2	8,3	0,77
VK1T 035 036	5,68	0,53	26,2	665	31,3	794	5,9	0,55	11,0	3,4	8,8	0,81
VK1T 035 038	6,05	0,56	26,2	665	33,3	845	6,3	0,58	11,3	3,5	9,2	0,86
VK1T 035 042	6,77	0,63	26,2	665	37,3	946	7,1	0,66	12,0	3,7	10,2	0,95
VK1T 035 046	7,50	0,70	26,2	665	41,3	1048	7,9	0,73	12,7	3,9	11,2	1,04
VK1T 035 048	7,87	0,73	26,2	665	43,3	1099	8,3	0,77	13,0	4,0	11,7	1,08
VK1T 035 050	-	-	-	-	-	-	-	-	-	-	-	-
VK1T 035 054	-	-	-	-	-	-	-	-	-	-	-	-
VK1T 035 058	-	-	-	-	-	-	-	-	-	-	-	-
VK1T 035 060	-	-	-	-	-	-	-	-	-	-	-	-
VK1T 035 062	-	-	-	-	-	-	-	-	-	-	-	-
VK1T 035 066	-	-	-	-	-	-	-	-	-	-	-	-
VK1T 035 070	-	-	-	-	-	-	-	-	-	-	-	-
VK1T 035 074	-	-	-	-	-	-	-	-	-	-	-	-
VK1T 035 078	-	-	-	-	-	-	-	-	-	-	-	-

MULTIPLE ASSEMBLIES

All hybrid casement windows may be mullered above, below, or beside other hybrid casement windows, or other hybrid window products. Factory assembled mulls are limited in height (99"), width (150"), and a total area (60 square feet).

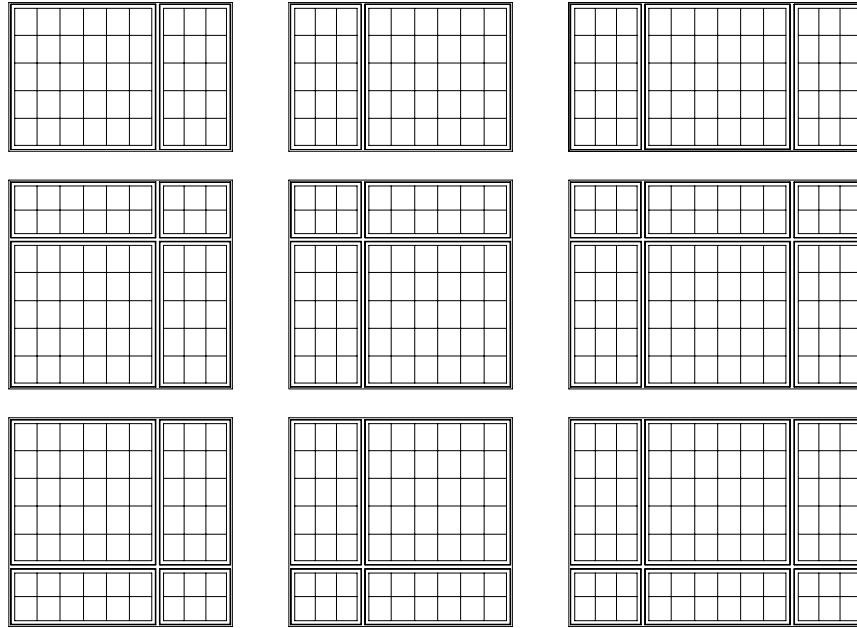

HANDING AND OPERATION

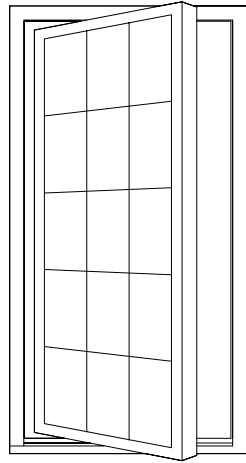

**LEFT
HAND**

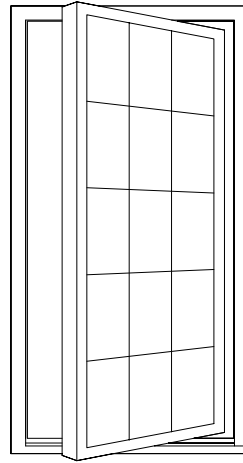

**RIGHT
HAND**

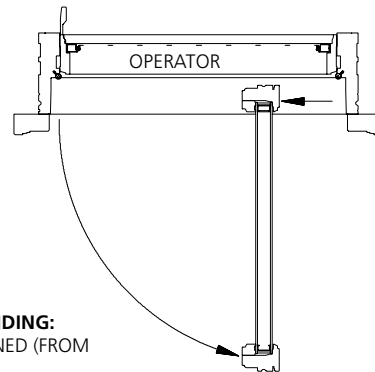
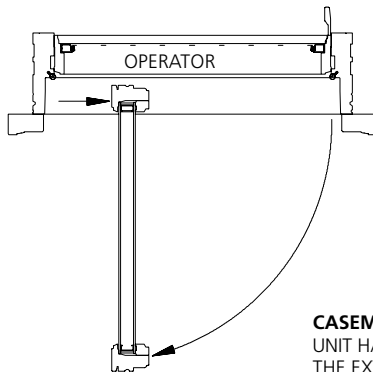

CASEMENT UNIT HANDING:
UNIT HANDING IS DEFINED (FROM
THE EXTERIOR) AS THE
DIRECTION THE SASH OPENS.

ELEVATION DRAWING GUIDE

Height:
 Rough Opening 54 3/4" - 1391mm
 Frame Size 54" - 1372mm
 Glass Size 47 5/8" - 1210mm

Width:
 Rough Opening 27 3/4" - 705mm
 Frame Size 27" - 686mm
 Glass Size 20 5/8" - 524mm

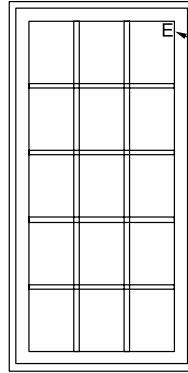

Window meets Egress as per Canadian NBC

OUTSIDE OF FRAME

VK1T027054

BOOK CODE

'VK' INDICATES DF3103 HYBRID CASEMENT SERIES

THE NUMBER INDICATES THE NUMBER OF UNITS MULLED TOGETHER

'T' INDICATES DUAL GLAZED PRODUCT

THE NEXT THREE NUMBERS INDICATE THE UNIT HEIGHT IN INCHES

THE FIRST THREE NUMBERS INDICATE THE UNIT WIDTH IN INCHES

GENERAL CASEMENT NOTES

1. ALL HYBRID CASMENT UNITS ARE AVAILABLE AS OPERATING OR STATIONARY UNITS.
2. UNIT ELEVATIONS ARE SHOWN WITHOUT EXTERIOR TRIM.

ELEVATION SYMBOL LEGEND:

- E** BASIC UNIT CLEAR OPENING EXCEEDS 15" IN WIDTH, 15" IN HEIGHT & A MINIMUM OF 3.77 SQ. FT. UNOBSTRUCTED OPENING BASED ON CANADIAN NBC
- E*** BASIC UNIT CLEAR OPENING REQUIRES EGRESS HINGES TO EXCEED 15" IN WIDTH, 15" IN HEIGHT & A MINIMUM, OF 3.77 SQ. FT. UNOBSTRUCTED OPENING BASED ON CANADIAN NBC

CASEMENT PICTURE COMBINATIONS

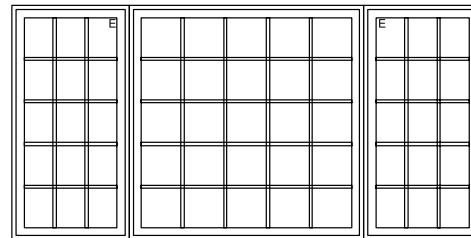











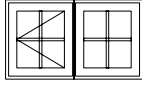
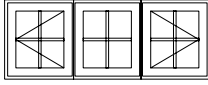
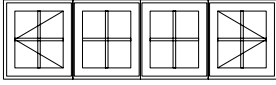

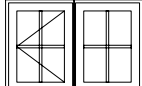
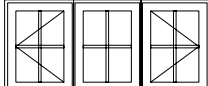
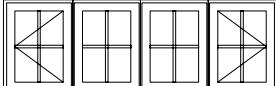

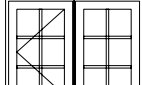
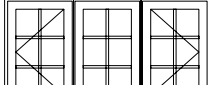
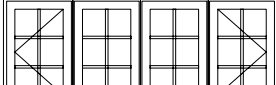



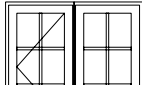
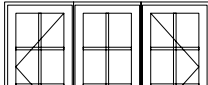

VK3|T108050

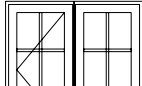
INDICATES IN 3 UNEVEN SECTIONS

17" Units (1-2 sections)

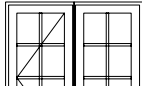
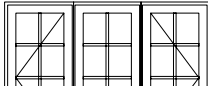
Dim Col CADRE VERRE	17 3/4"•451mm 17"•432mm 10 5/8"•270mm	34 3/4"•883mm 34"•864mm 11 1/16"•281mm	17 3/4"•451mm 17"•432mm 10 5/8"•270mm	34 3/4"•883mm 34"•864mm 11 1/16"•281mm	17 3/4"•451mm 17"•432mm 10 5/8"•270mm	34 3/4"•883mm 34"•864mm 11 1/16"•281mm
50 22 3/4"•584mm FRAME GLASS 15 5/8"•397mm						
42 20 3/4"•527mm FRAME GLASS 19 5/8"•488mm			48 3/4"•1238mm 48"•1219mm 41 5/8"•1057mm			
30 18 3/4"•476mm FRAME GLASS 23 5/8"•600mm			50 3/4"•1289mm 50"•1270mm 43 5/8"•1108mm			
34 18 3/4"•476mm FRAME GLASS 27 5/8"•702mm			54 3/4"•1391mm 54"•1372mm 47 5/8"•1210mm			
36 18 3/4"•476mm FRAME GLASS 29 5/8"•752mm			54 3/4"•1391mm 54"•1372mm 47 5/8"•1210mm			
36 18 3/4"•476mm FRAME GLASS 31 5/8"•803mm			58 3/4"•1492mm 58"•1473mm 51 5/8"•1311mm			
42 18 3/4"•476mm FRAME GLASS 35 5/8"•905mm			60 3/4"•1543mm 60"•1524mm 53 5/8"•1362mm			
46 18 3/4"•476mm FRAME GLASS 39 5/8"•1006mm			62 3/4"•1594mm 62"•1575mm 55 5/8"•1413mm			
						66 3/4"•1696mm 66"•1676mm 59 5/8"•1514mm
						70 3/4"•1797mm 70"•1778mm 63 5/8"•1616mm
						74 3/4"•1899mm 74"•1880mm 67 5/8"•1718mm
						78 3/4"•2000mm 78"•1981mm 71 5/8"•1819mm

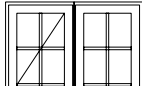
19" Units (1-2-3-4 sections)

Dim. Col. CADRE FEUILLE GLASS VERRE	19 3/4"•502mm 19"•483mm 12 5/8"•321mm	38 3/4"•984mm 38"•965mm 13 1/16"•332mm	57 3/4"•1467mm 57"•1448mm 13 1/4"•336mm	76 3/4"•1949mm 76"•1930mm 13 1/4"•336mm
22 3/8"•567mm 22"•559mm 15 5/8"•397mm	 VK1T019022	 VK2T038022	 VK3T057022	 VK4T076022
29 3/8"•747mm 29"•739mm 19 5/8"•498mm	 VK1T019026	 VK2T038026	 VK3T057026	 VK4T076026
30 3/4"•771mm 30"•763mm 23 5/8"•600mm	 VK1T019030	 VK2T038030	 VK3T057030	 VK4T076030
34 3/8"•874mm 34"•866mm 27 5/8"•702mm	 VK1T019034	 VK2T038034	 VK3T057034	 VK4T076034
36 3/8"•917mm 36"•909mm 29 5/8"•752mm	 VK1T019036	 VK2T038036	 VK3T057036	 VK4T076036
36 3/4"•930mm 36"•922mm 31 5/8"•803mm	 VK1T019038	 VK2T038038	 VK3T057038	 VK4T076038
42 3/4"•1087mm 42"•1079mm 35 5/8"•905mm	 VK1T019042	 VK2T038042	 VK3T057042	 VK4T076042
48 3/8"•1187mm 48"•1179mm 39 5/8"•1006mm	 VK1T019046	 VK2T038046	 VK3T057046	 VK4T076046

19" Units (1-2-3-4 sections) cont'd

NO. Di Col. FRAMES GLASS VERRE	19 3/4" • 502mm 19" • 483mm 12 5/8" • 321mm	38 3/4" • 984mm 38" • 965mm 13 1/16" • 332mm	57 3/4" • 1467mm 57" • 1448mm 13 1/4" • 336mm	76 3/4" • 1949mm 76" • 1930mm 13 1/4" • 336mm
49 3/4" • 1265mm 48" • 1219mm 41 5/8" • 1067mm				
VK1T019048	VK2T038048	VK3T057048	VK4T076048	
50 3/4" • 1295mm 50" • 1270mm 43 5/8" • 1108mm				
VK1T019050	VK2T038050	VK3T057050	VK4T076050	
54 3/4" • 1397mm 54" • 1372mm 47 5/8" • 1210mm				
VK1T019054	VK2T038054	VK3T057054	VK4T076054	
56 3/4" • 1437mm 56" • 1412mm 51 5/8" • 1311mm				
VK1T019058	VK2T038058	VK3T057058	VK4T076058	
60 3/4" • 1547mm 60" • 1522mm 53 5/8" • 1362mm				
VK1T019060	VK2T038060	VK3T057060	VK4T076060	
64 3/4" • 1647mm 64" • 1622mm 55 5/8" • 1413mm				
VK1T019062	VK2T038062	VK3T057062	VK4T076062	

19" Units (1-2-3-4 sections) cont'd

Dim Col
 CADRE
 FRAME
 CLASSE
 VERRE

19 3/4"•502mm
 19"•483mm
 12 5/8"•321mm

65 1/2"•1651mm
 65"•1651mm
 59 5/8"•1514mm

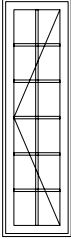

VK1T019066

38 3/4"•984mm
 38"•965mm
 13 1/16"•332mm

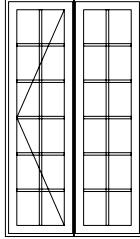

VK2T038066

57 3/4"•1467mm
 57"•1448mm
 13 1/4"•338mm

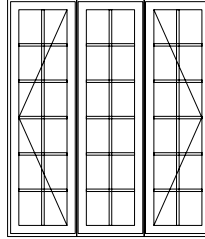

VK3T057066

76 3/4"•1949mm
 76"•1930mm
 13 1/4"•338mm

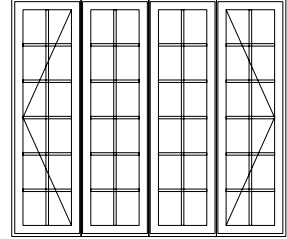

VK4T076066

70 3/4"•1797mm
 70"•1778mm
 63 5/8"•1616mm

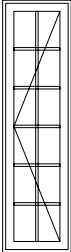

VK1T019070

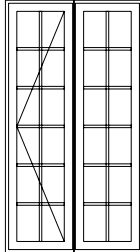

VK2T038070

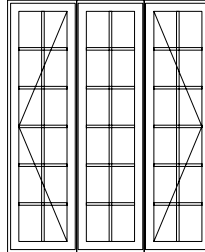

VK3T057070

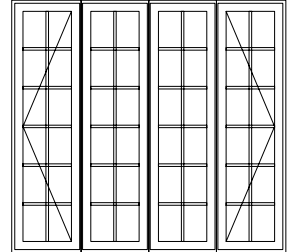

VK4T076070

74 3/4"•1899mm
 74"•1880mm
 67 5/8"•1718mm

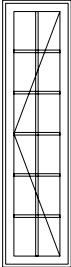

VK1T019074

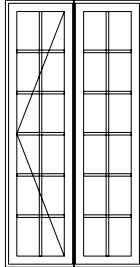

VK2T038074

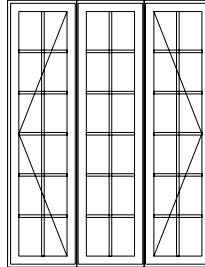

VK3T057074

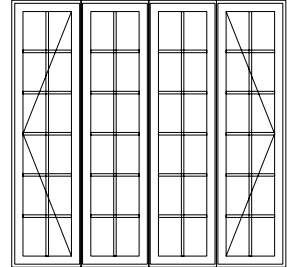

VK4T076074

78 3/4"•2000mm
 78"•1981mm
 71 5/8"•1819mm

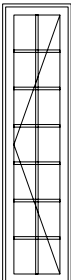

VK1T019078

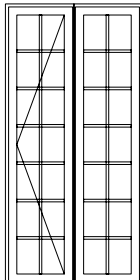

VK2T038078

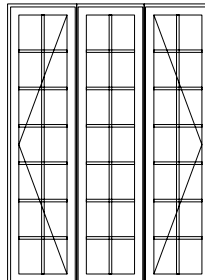

VK3T057078

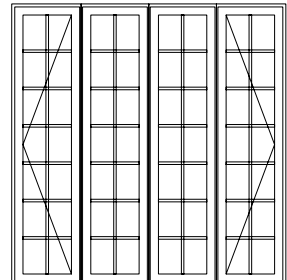

VK4T076078

19" Units (5 sections)

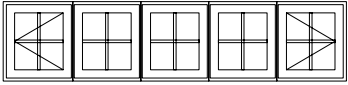
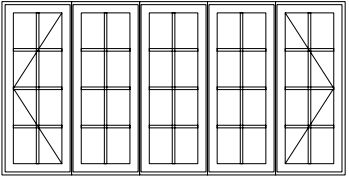
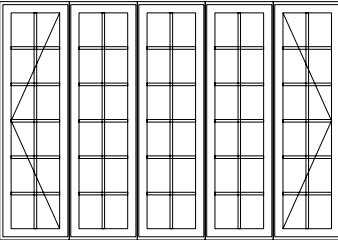
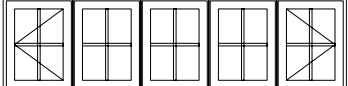
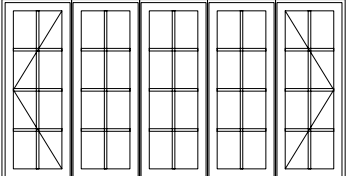
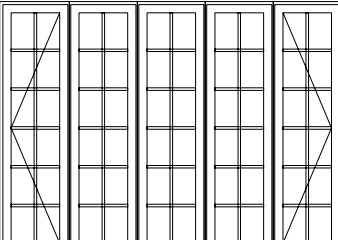
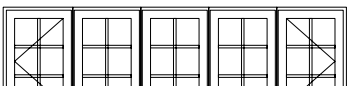
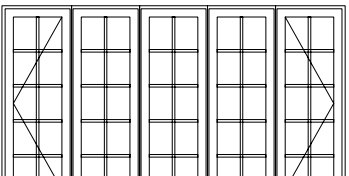
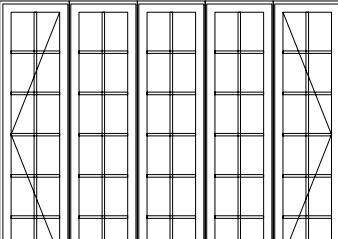
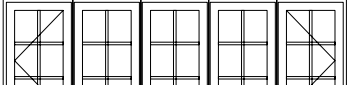
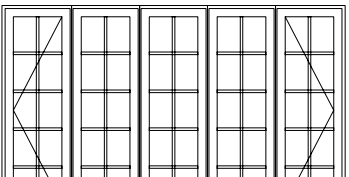
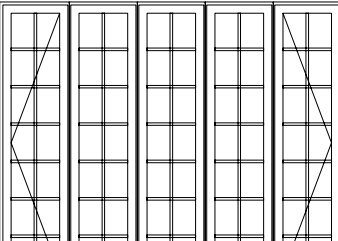
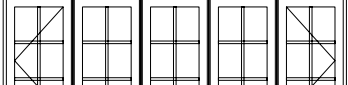
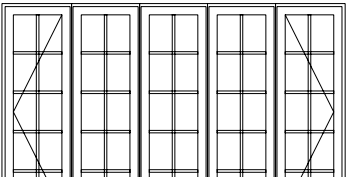
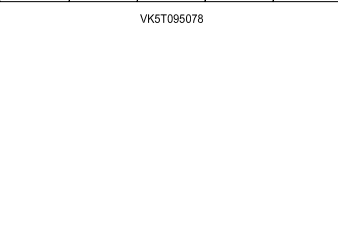
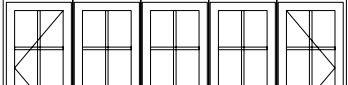
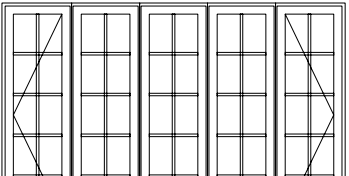
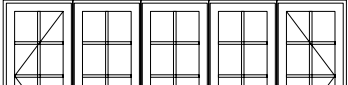
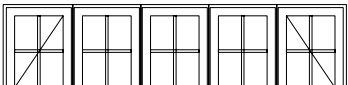
Dim. Col. RSO FRAME CADRE GLASS VERRE	95 3/4" • 2432mm 35" • 2413mm 13 5/16" • 339mm	Dim. Col. RSO FRAME CADRE GLASS VERRE	95 3/4" • 2432mm 35" • 2413mm 13 5/16" • 339mm	Dim. Col. RSO FRAME CADRE GLASS VERRE	95 3/4" • 2432mm 35" • 2413mm 13 5/16" • 339mm
22 3/4" • 578mm 22" • 559mm 15 5/8" • 397mm		48 3/4" • 1238mm 48" • 1219mm 41 5/8" • 1057mm		66 3/4" • 1685mm 66" • 1676mm 59 5/8" • 1514mm	
26 3/4" • 679mm 26" • 660mm 19 5/8" • 498mm		50 3/4" • 1299mm 50" • 1279mm 43 5/8" • 1108mm		70 3/4" • 1797mm 70" • 1778mm 63 5/8" • 1618mm	
30 3/4" • 781mm 30" • 762mm 23 5/8" • 600mm		54 3/4" • 1391mm 54" • 1372mm 47 5/8" • 1210mm		74 3/4" • 1899mm 74" • 1880mm 67 5/8" • 1718mm	
34 3/4" • 883mm 34" • 864mm 27 5/8" • 702mm		58 3/4" • 1492mm 58" • 1473mm 51 5/8" • 1311mm		78 3/4" • 2000mm 78" • 1981mm 71 5/8" • 1819mm	
36 3/4" • 933mm 36" • 914mm 29 5/8" • 752mm		60 3/4" • 1544mm 60" • 1524mm 53 5/8" • 1362mm		82 3/4" • 2102mm 82" • 2083mm 75 5/8" • 1919mm	
38 3/4" • 984mm 38" • 965mm 31 5/8" • 803mm		62 3/4" • 1596mm 62" • 1575mm 55 5/8" • 1413mm			
42 3/4" • 1086mm 42" • 1067mm 35 5/8" • 905mm					
46 3/4" • 1187mm 46" • 1168mm 39 5/8" • 1006mm					

21" Units (1-2-3 sections)

21 3/4" • 552mm
 21" • 533mm
 14 5/8" • 371mm

22 2/2" • 559mm
 15 5/8" • 397mm



VK1T021022

26 5/8" • 676mm
 26" • 660mm
 19 5/8" • 498mm



VK1T021026

30 5/8" • 779mm
 30" • 762mm
 23 5/8" • 600mm



VK1T021030

34 5/8" • 882mm
 34" • 864mm
 27 5/8" • 702mm



VK1T021034

38 5/8" • 985mm
 38" • 968mm
 29 5/8" • 752mm



VK1T021036

36 5/8" • 941mm
 36" • 924mm
 31 5/8" • 803mm



VK1T021038

42 5/8" • 1097mm
 42" • 1067mm
 35 5/8" • 905mm



VK1T021042

40 5/8" • 1041mm
 40" • 1016mm
 39 5/8" • 1006mm



VK1T021046

42 3/4" • 1086mm
 42" • 1067mm
 15 1/16" • 383mm

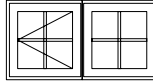

VK2T042022

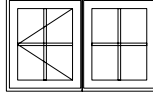

VK2T042026

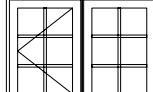

VK2T042030

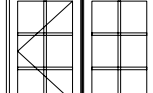

VK2T042034

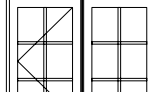

VK2T042036

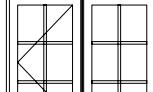

VK2T042038

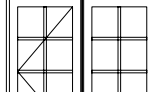

VK2T042042

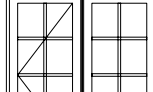

VK2T042046

64 3/4" • 1645mm
 64" • 1626mm
 15 9/16" • 395mm

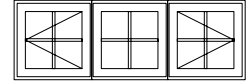

VK3T064022

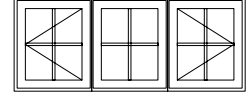

VK3T064026

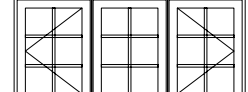

VK3T064030



VK3T064034



VK3T064036

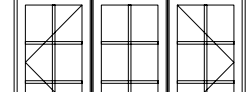

VK3T064038

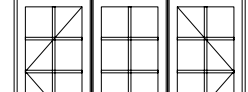

VK3T064042

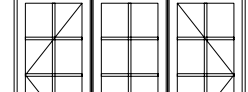

VK3T064046

21" Units (1-2-3 sections) cont'd

Unit
 DIM. C.A.
 FRAME CADRE
 GLASS VERRE

21 3/4" • 552mm
 21" • 533mm
 14 5/8" • 371mm

42 3/4" • 1089mm
 42" • 1067mm
 15 1/16" • 383mm

64 3/4" • 1645mm
 64" • 1626mm
 15 9/16" • 395mm

49 5/8" • 1250mm
 50" • 1270mm
 41 5/8" • 1057mm

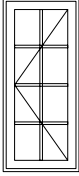

VK1T021048

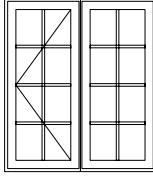

VK2T042048

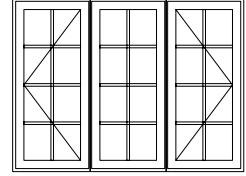

VK3T064048

50 5/8" • 1276mm
 50" • 1270mm
 43 5/8" • 1108mm

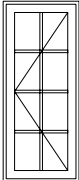

VK1T021050

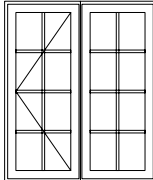

VK2T042050

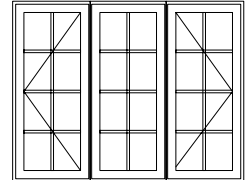

VK3T064050

54 5/8" • 1397mm
 54" • 1372mm
 47 5/8" • 1210mm

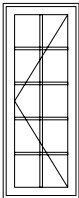

VK1T021054

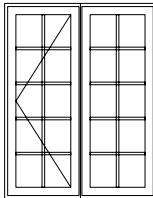

VK2T042054

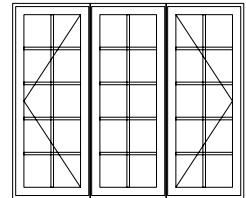

VK3T064054

58 5/8" • 1472mm
 58" • 1472mm
 51 5/8" • 1311mm

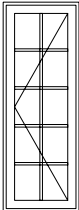

VK1T021058

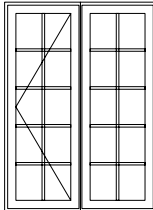

VK2T042058

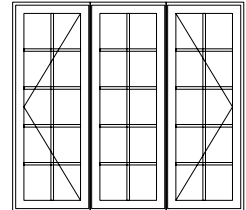

VK3T064058

60 5/8" • 1524mm
 60" • 1524mm
 53 5/8" • 1362mm

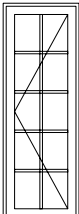

VK1T021060

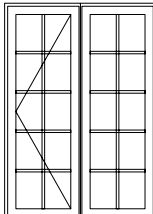

VK2T042060

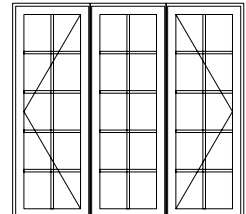

VK3T064060

64 5/8" • 1625mm
 64" • 1625mm
 55 5/8" • 1413mm

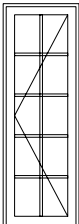

VK1T021062

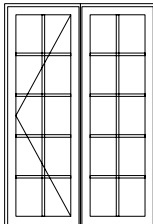

VK2T042062

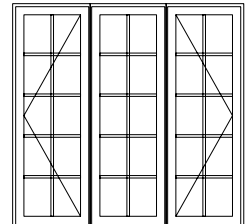

VK3T064062

21" Units (1-2-3 sections) cont'd

RES. Dim. Col.
 CADRE 21" • 533mm
 FRAM. 14 5/8" • 371mm
 GLASS VERRE

66 3/4" • 1699mm
 56" • 1422mm
 59 5/8" • 1514mm

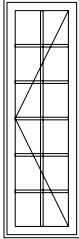

VK1T021066

70 3/4" • 1797mm
 60" • 1524mm
 63 5/8" • 1616mm

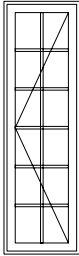

VK1T021070

74 3/4" • 1899mm
 64" • 1626mm
 67 5/8" • 1718mm

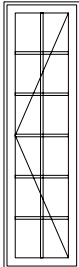

VK1T021074

78 3/8" • 1981mm
 68" • 1727mm
 71 5/8" • 1819mm

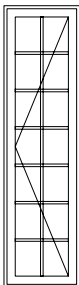

VK1T021078

42 3/4" • 1086mm
 42" • 1067mm
 15 1/16" • 383mm

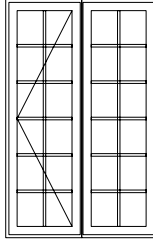

VK2T042066

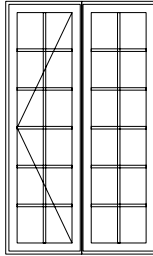

VK2T042070

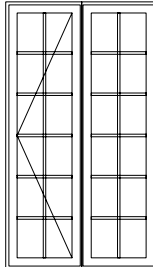

VK2T042074

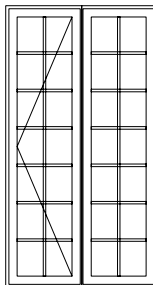

VK2T042078

64 3/4" • 1645mm
 64" • 1626mm
 15 9/16" • 395mm

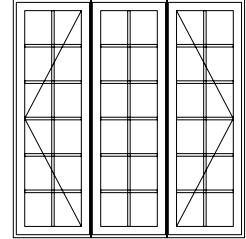

VK3T064066

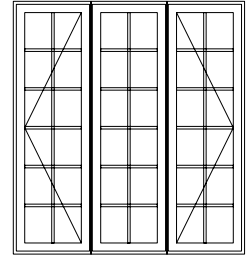

VK3T064070

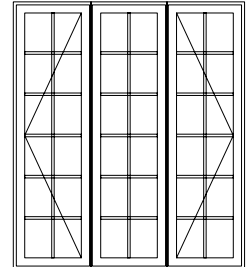



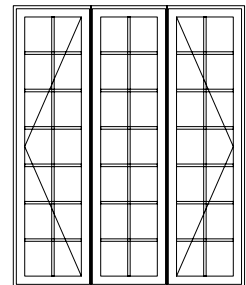





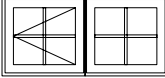
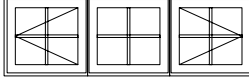
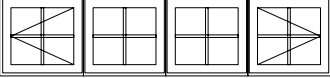

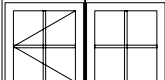
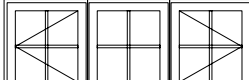



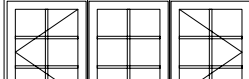

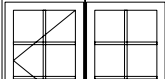
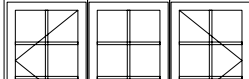

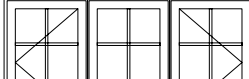

VK3T064074

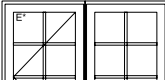
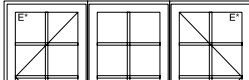

VK3T064078

23" Units (1-2-3-4 sections)

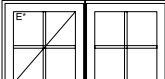
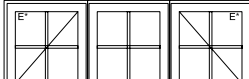
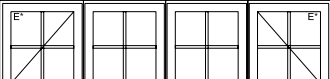
Dim. Col. S CAJRE FRAMES GLASS VERRE	23 3/4" • 603mm 23" • 584mm 16 5/8" • 422mm	46 3/4" • 1187mm 46" • 1168mm 17 1/16" • 433mm	69 3/4" • 1772mm 69" • 1753mm 17 1/4" • 438mm	92 3/4" • 2356mm 92" • 2337mm 17 1/4" • 438mm
42 1/2" • 1067mm 29" • 738mm 19 5/8" • 498mm	 VK1T023022	 VK2T046022	 VK3T069022	 VK4T092022
40 1/2" • 1027mm 28" • 711mm 19 5/8" • 498mm	 VK1T023026	 VK2T046026	 VK3T069026	 VK4T092026
30 1/2" • 762mm 30" • 762mm 23 5/8" • 600mm	 VK1T023030	 VK2T046030	 VK3T069030	 VK4T092030
54 1/2" • 1393mm 34" • 863mm 27 5/8" • 702mm	 VK1T023034	 VK2T046034	 VK3T069034	 VK4T092034
30 1/2" • 762mm 30" • 762mm 29 5/8" • 752mm	 VK1T023036	 VK2T046036	 VK3T069036	 VK4T092036
30 1/2" • 762mm 30" • 762mm 31 5/8" • 803mm	 VK1T023038	 VK2T046038	 VK3T069038	 VK4T092038
42 1/2" • 1067mm 42" • 1067mm 35 5/8" • 905mm	 VK1T023042	 VK2T046042	 VK3T069042	 VK4T092042
40 1/2" • 1027mm 39 5/8" • 1006mm	 VK1T023046	 VK2T046046	 VK3T069046	 VK4T092046

23" Units (1-2-3-4 sections) cont'd

Dim. Col.
 CADRE
 FRAME
 GLASS
 VERRE

23 3/4" • 603mm
 23" • 584mm
 16 5/8" • 422mm

46 3/4" • 1187mm
 46" • 1168mm
 17 1/16" • 433mm

69 3/4" • 1772mm
 69" • 1753mm
 17 1/4" • 438mm

92 3/4" • 2356mm
 92" • 2337mm
 17 1/4" • 438mm

48 3/4" • 1248mm
 48" • 1219mm
 41 5/8" • 1057mm

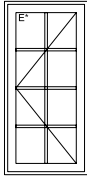

VK1T023048

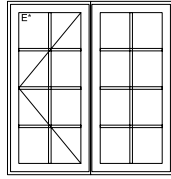

VK2T046048

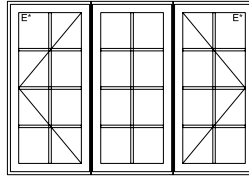

VK3T069048

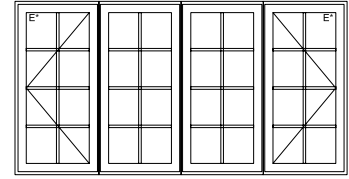

VK4T092048

50 3/4" • 1299mm
 50" • 1270mm
 43 5/8" • 1108mm

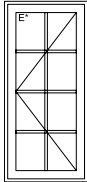

VK1T023050

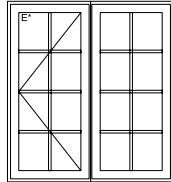

VK2T046050

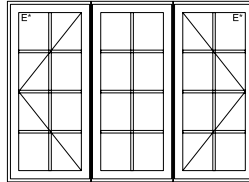

VK3T069050

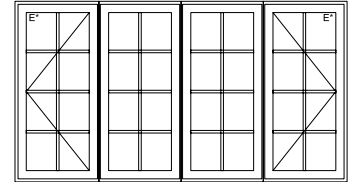

VK4T092050

54 3/4" • 1397mm
 54" • 1372mm
 47 5/8" • 1210mm

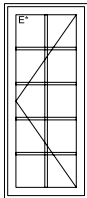

VK1T023054

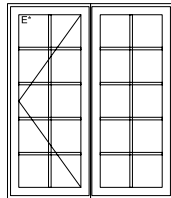

VK2T046054

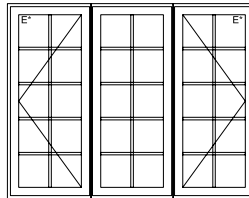

VK3T069054

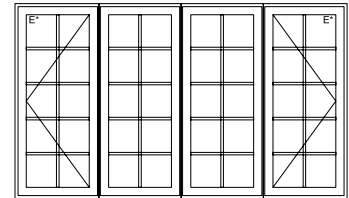

VK4T092054

58 3/4" • 1495mm
 58" • 1470mm
 51 5/8" • 1311mm

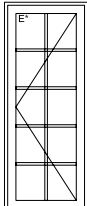

VK1T023058

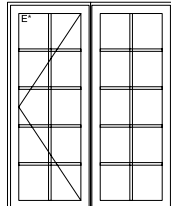

VK2T046058

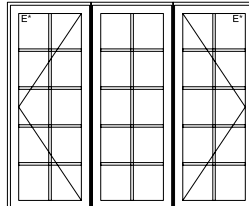

VK3T069058

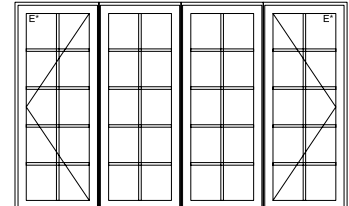

VK4T092058

60 3/4" • 1549mm
 60" • 1524mm
 53 5/8" • 1362mm

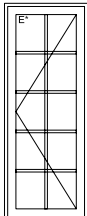

VK1T023060

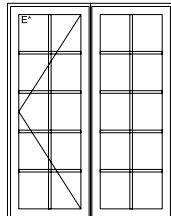

VK2T046060

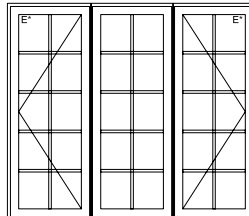

VK3T069060

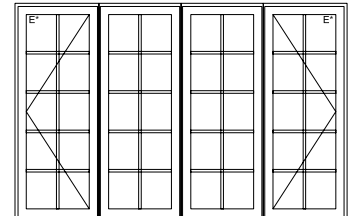

VK4T092060

62 3/4" • 1603mm
 62" • 1578mm
 55 5/8" • 1413mm

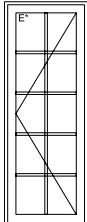

VK1T023062

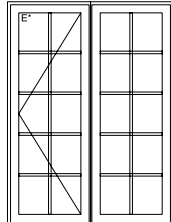

VK2T046062

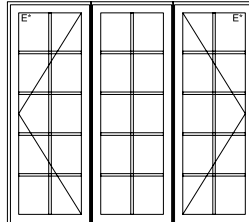

VK3T069062

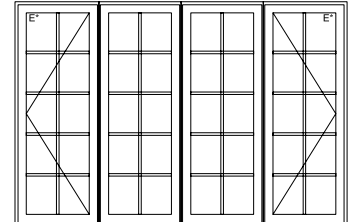

VK4T092062

23" Units (1-2-3-4 sections) cont'd

Dim. Cx
 CADRE
 FRAME
 GLASS
 VERRE

23 3/4"•603mm
 23"•584mm
 16 5/8"•422mm

46 3/4"•1187mm
 46"•1168mm
 17 1/16"•433mm

69 3/4"•1772mm
 69"•1753mm
 17 1/4"•438mm

92 3/4"•2356mm
 92"•2337mm
 17 1/4"•438mm

69 3/4"•1772mm
 69"•1753mm
 59 5/8"•1514mm

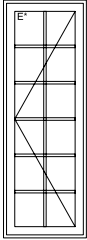

VK1T023066

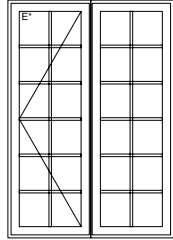

VK2T046066

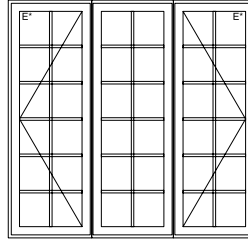

VK3T069066

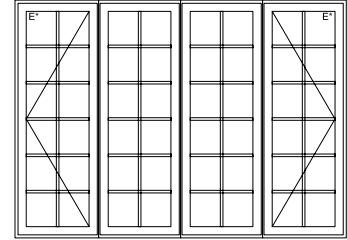

VK4T092066

70 3/4"•1793mm
 70"•1776mm
 63 5/8"•1616mm

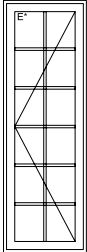

VK1T023070

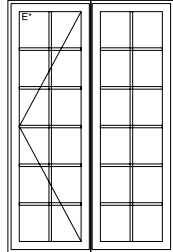

VK2T046070

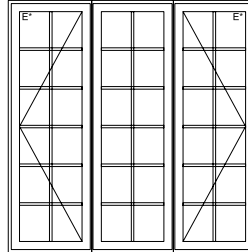

VK3T069070

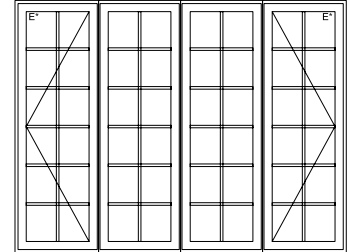

VK4T092070

74 3/4"•1897mm
 74"•1880mm
 67 5/8"•1718mm

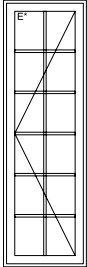

VK1T023074

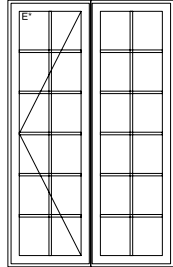

VK2T046074

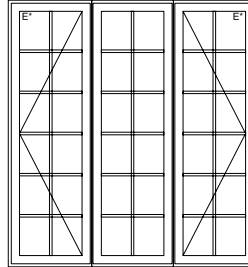

VK3T069074

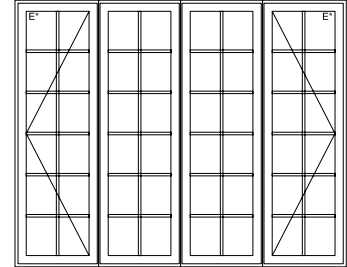

VK4T092074

76 3/4"•1941mm
 76"•1924mm
 71 5/8"•1819mm

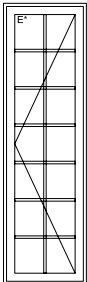

VK1T023076

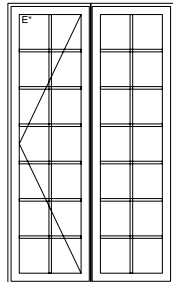

VK2T046076

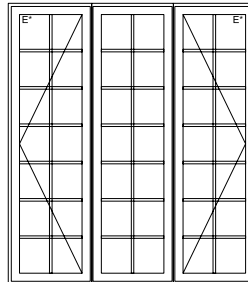

VK3T069076

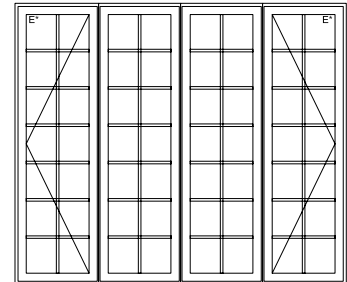

VK4T092076

23" Units (5 sections)

INSIDE
 FINISH
 CORE
 EXTERIOR
 FINISH

115 3/4"•2940mm
 113"•2821mm
 17 5/16"•440mm

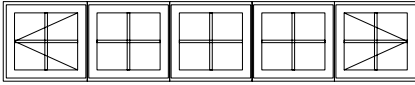

VKST115022

20 3/8"•519mm
 26"•660mm
 19 5/8"•488mm

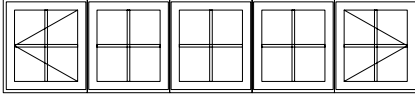

VKST115026

30 3/8"•767mm
 30"•762mm
 23 5/8"•600mm

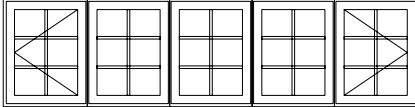

VKST115030

34 1/8"•864mm
 34"•864mm
 27 5/8"•702mm

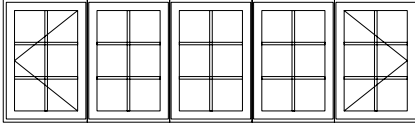

VKST115034

36 1/8"•914mm
 36"•914mm
 29 5/8"•752mm

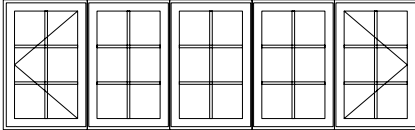

VKST115036

36 3/8"•925mm
 31 3/8"•803mm

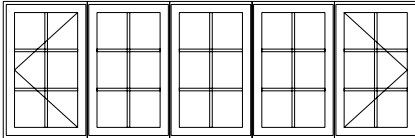

VKST115038

42 3/8"•1087mm
 42"•1067mm
 35 5/8"•905mm

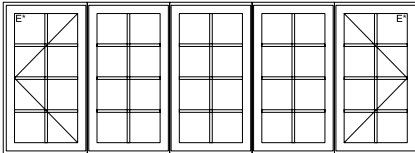

VKST115042

46 3/8"•1187mm
 46"•1167mm
 39 5/8"•1008mm

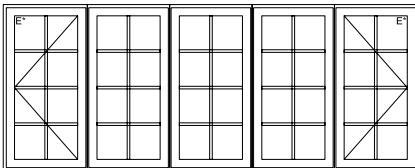

VKST115046

INSIDE
 FINISH
 CORE
 EXTERIOR
 FINISH

115 3/4"•2940mm
 113"•2821mm
 17 5/16"•440mm

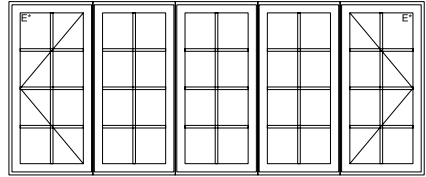

VKST115048

48 3/4"•1238mm
 48"•119mm
 41 5/8"•1057mm

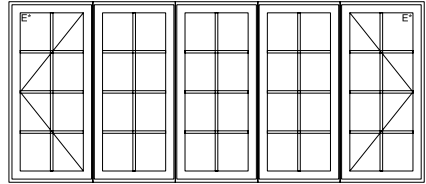

VKST115050

50 3/4"•1289mm
 50"•1270mm
 43 5/8"•1108mm

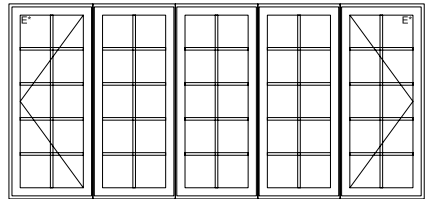

VKST115054

54 3/4"•1391mm
 54"•1372mm
 47 5/8"•1210mm

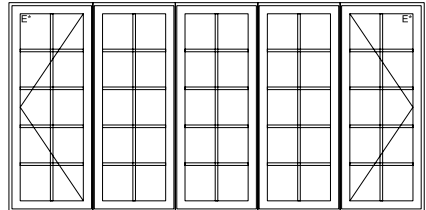

VKST115058

58 3/4"•1492mm
 58"•1473mm
 51 5/8"•1311mm

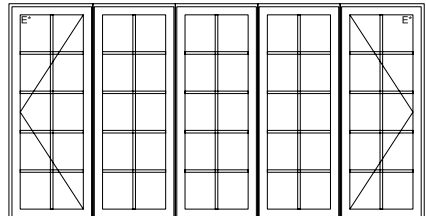

VKST115060

60 3/4"•1543mm
 60"•1524mm
 53 5/8"•1362mm

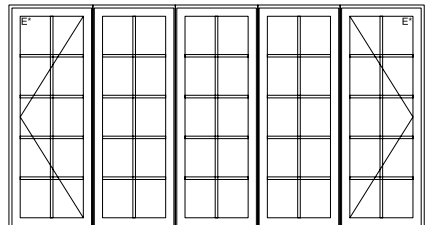

VKST115062

62 3/4"•1594mm
 62"•1575mm
 55 5/8"•1413mm

23" Units (5 sections) cont'd

REG. 2010-04
 MADE IN CANADA
 GLASS VERRE

115 3/4" • 2940mm
 115" • 2921mm
 17 5/16" • 440mm

66 3/4" • 1685mm
 66" • 1676mm
 59 5/8" • 1514mm

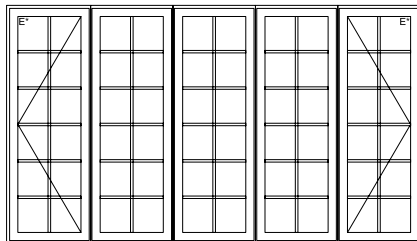

VKST115066

70 3/4" • 1797mm
 70" • 1778mm
 63 5/8" • 1618mm

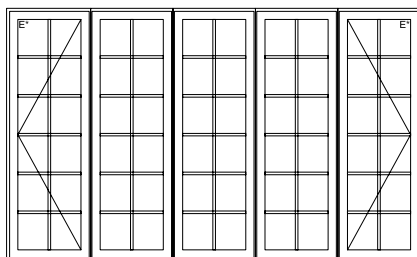

VKST115070

74 3/4" • 1899mm
 74" • 1880mm
 67 5/8" • 1718mm

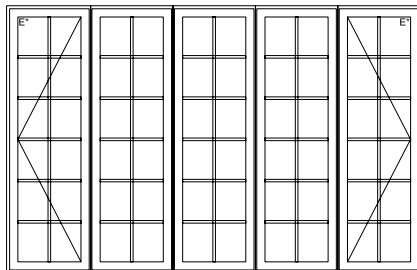

VKST115074

78 3/4" • 2000mm
 78" • 1981mm
 71 5/8" • 1819mm

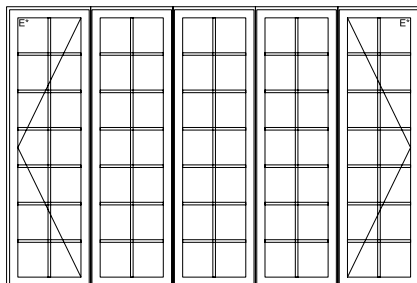

VKST115078

25 " Units (1 section)

Dim. CA.
 CADRE
 VERRE

25 3/4" • 654mm
 25" • 635mm
 18 5/8" • 473mm

22 3/4" • 576mm
 15 5/8" • 397mm



VK1T025022

26 3/4" • 679mm
 19 5/8" • 498mm



VK1T025026

30 3/4" • 781mm
 23 5/8" • 600mm



VK1T025030

34 3/4" • 883mm
 27 5/8" • 702mm



VK1T025034

36 3/4" • 933mm
 29 5/8" • 752mm



VK1T025036

38 3/4" • 984mm
 31 5/8" • 803mm



VK1T025038

42 3/4" • 1086mm
 35 5/8" • 905mm



VK1T025042

46 3/4" • 1187mm
 39 5/8" • 1006mm



VK1T025046

25 3/4" • 654mm
 25" • 635mm
 18 5/8" • 473mm

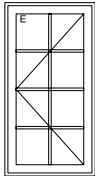

VK1T025048

48 3/4" • 1238mm
 46" • 1219mm
 41 5/8" • 1057mm

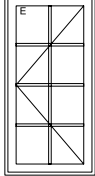

VK1T025050

50 3/4" • 1289mm
 50" • 1270mm
 43 5/8" • 1108mm

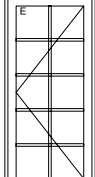

VK1T025054

54 3/4" • 1391mm
 54" • 1372mm
 47 5/8" • 1210mm

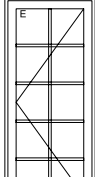

VK1T025058

58 3/4" • 1492mm
 58" • 1473mm
 51 5/8" • 1311mm

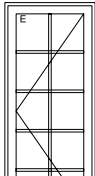

VK1T025060

60 3/4" • 1543mm
 60" • 1524mm
 53 5/8" • 1362mm

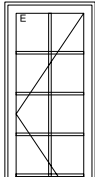

VK1T025062

62 3/4" • 1594mm
 62" • 1575mm
 55 5/8" • 1413mm

25 3/4" • 654mm
 25" • 635mm
 18 5/8" • 473mm

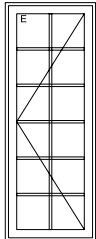

VK1T025066

66 3/4" • 1695mm
 66" • 1676mm
 59 5/8" • 1514mm

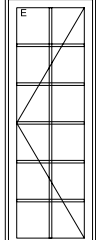

VK1T025070

70 3/4" • 1797mm
 70" • 1778mm
 63 5/8" • 1616mm

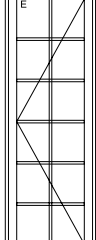

VK1T025074

74 3/4" • 1899mm
 74" • 1880mm
 67 5/8" • 1718mm

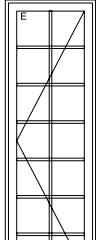

VK1T025078

78 3/4" • 2000mm
 78" • 1981mm
 71 5/8" • 1819mm

25" Units (5 sections)

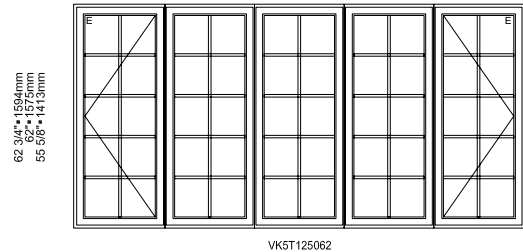
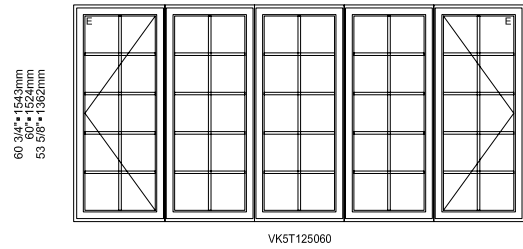
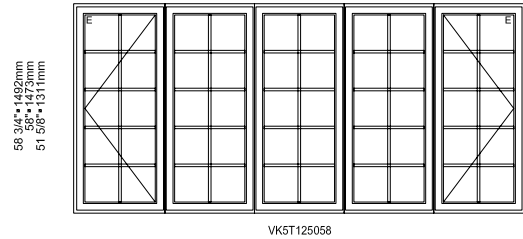
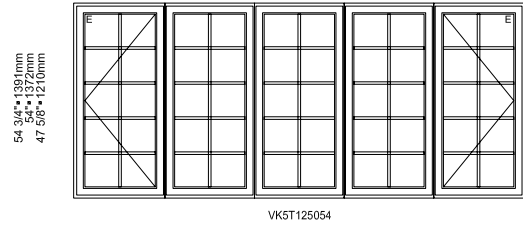
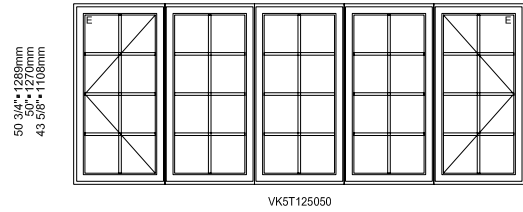
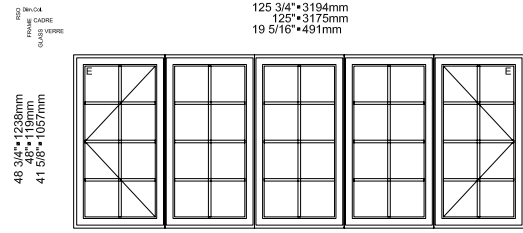
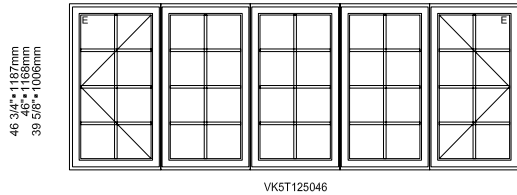
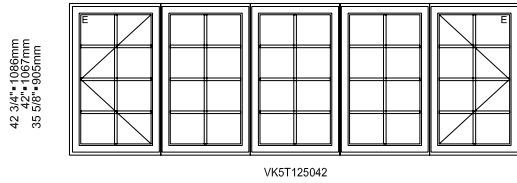
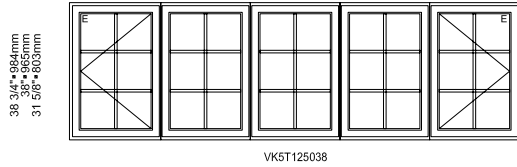
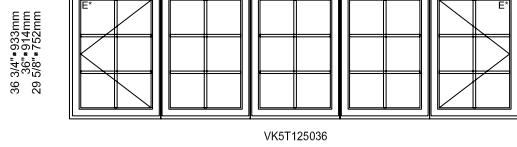
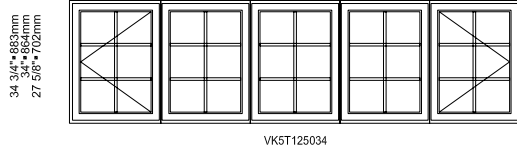
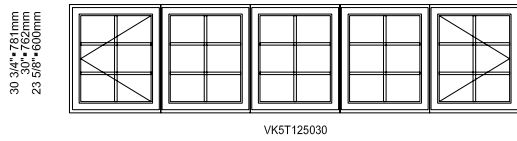
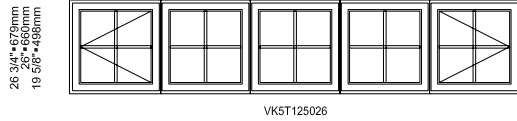
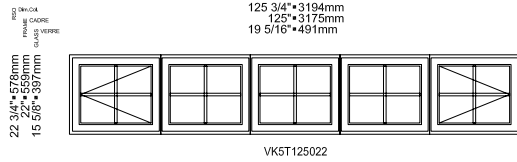

25" Units (5 sections) cont'd

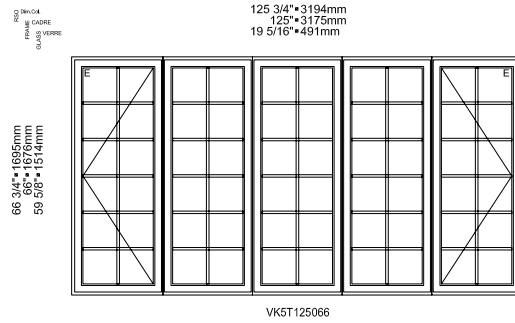

27" Units (1-2-3-4 sections)

Dr. Co.
 CADRE
 VERRE

22 3/4" • 569mm
 22 3/8" • 569mm
 15 5/8" • 397mm

27 3/4" • 705mm
 27" • 686mm
 20 5/8" • 524mm



VK1T027022

54 3/4" • 1391mm
 54" • 1372mm
 21 1/16" • 535mm

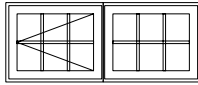

VK2T054022

81 3/4" • 2076mm
 81" • 2057mm
 21 1/4" • 539mm

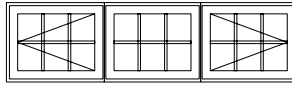

VK3T081022

108 3/4" • 2762mm
 108" • 2743mm
 21 1/4" • 539mm

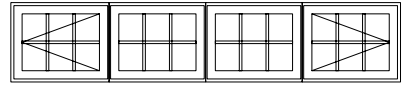

VK4T108022

26 3/4" • 679mm
 26 3/8" • 679mm
 19 5/8" • 498mm



VK1T027026

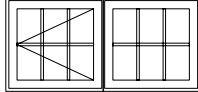

VK2T054026

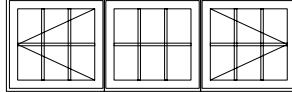

VK3T081026

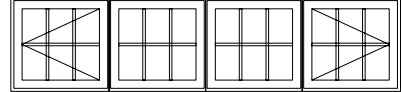

VK4T108026

30 3/4" • 774mm
 30 3/8" • 774mm
 23 5/8" • 600mm

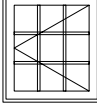

VK1T027030

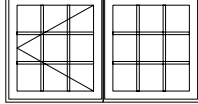

VK2T054030

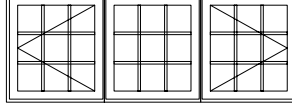

VK3T081030

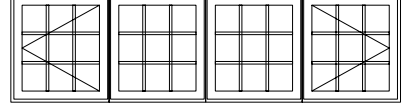

VK4T108030

34 3/4" • 884mm
 34 3/8" • 884mm
 27 5/8" • 702mm

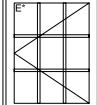

VK1T027034

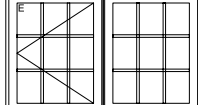

VK2T054034

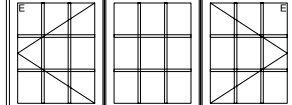

VK3T081034

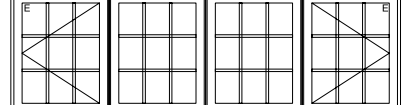

VK4T108034

36 3/4" • 930mm
 36 3/8" • 930mm
 29 5/8" • 752mm

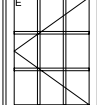

VK1T027036

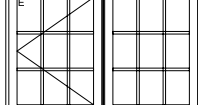

VK2T054036

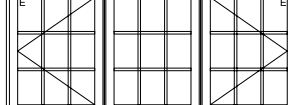

VK3T081036



VK4T108036

36 3/4" • 930mm
 36 3/8" • 930mm
 31 5/8" • 803mm

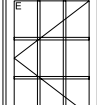

VK1T027038

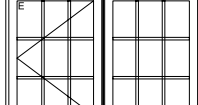

VK2T054038

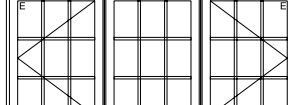

VK3T081038



VK4T108038

42 3/4" • 1087mm
 42 3/8" • 1087mm
 35 5/8" • 905mm

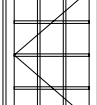

VK1T027042

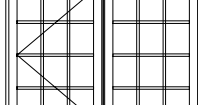

VK2T054042

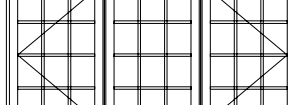

VK3T081042

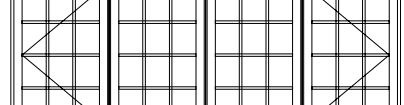

VK4T108042

40 3/4" • 1041mm
 40 3/8" • 1041mm
 39 5/8" • 1006mm

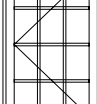

VK1T027046

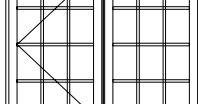

VK2T054046

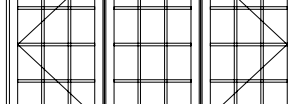

VK3T081046

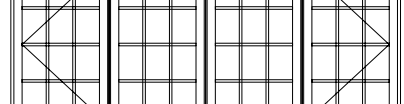

VK4T108046

27" Units (1-2-3-4 sections) cont'd

RSO Dim. Col.
 FRANKL CADRE
 GLASS VERRE

48 3/4" • 1238mm
 20 5/8" • 524mm

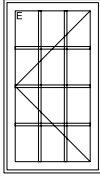

VK1T027048

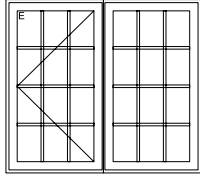

VK2T054048

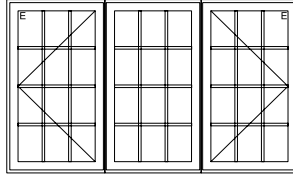

VK3T081048

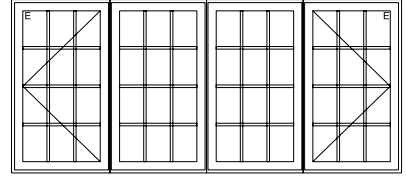

VK4T108048

50 3/4" • 1285mm
 43 5/8" • 1109mm

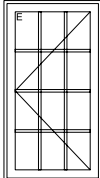

VK1T027050

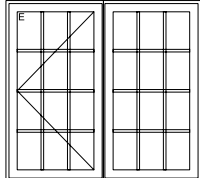

VK2T054050

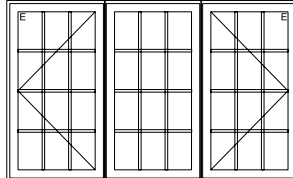

VK3T081050

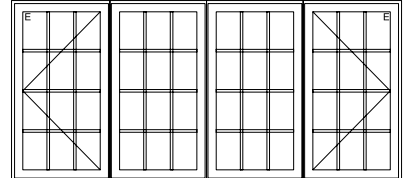

VK4T108050

54 3/4" • 1391mm
 47 5/8" • 1210mm

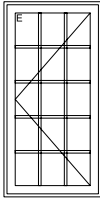

VK1T027054

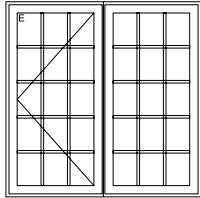

VK2T054054

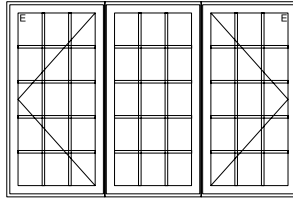

VK3T081054

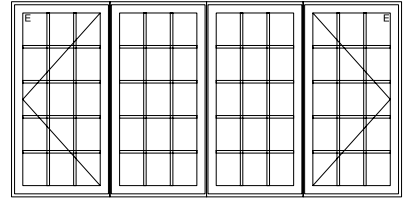

VK4T108054

56 3/4" • 1432mm
 51 5/8" • 1311mm

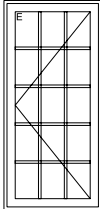

VK1T027058

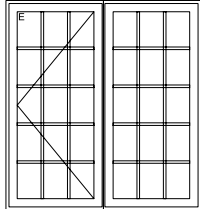

VK2T054058

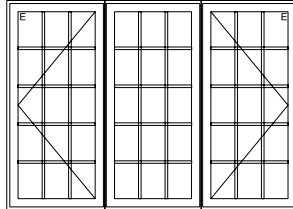

VK3T081058

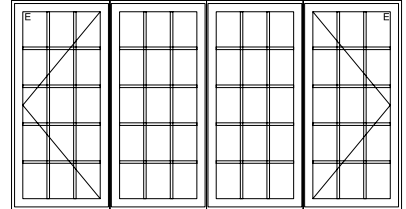

VK4T108058

60 3/4" • 1543mm
 53 5/8" • 1362mm

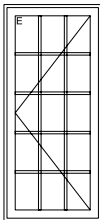

VK1T027060

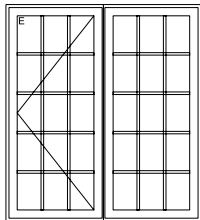

VK2T054060

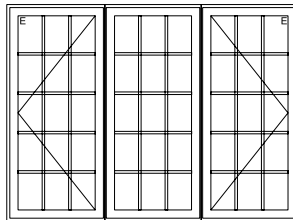

VK3T081060

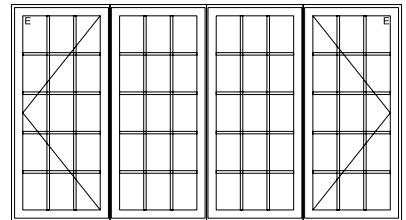

VK4T108060

62 3/4" • 1594mm
 55 5/8" • 1413mm

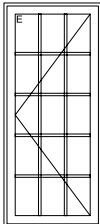

VK1T027062

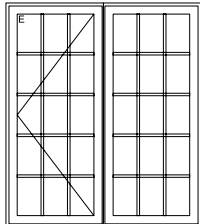

VK2T054062

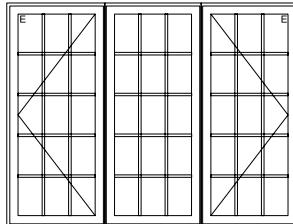

VK3T081062

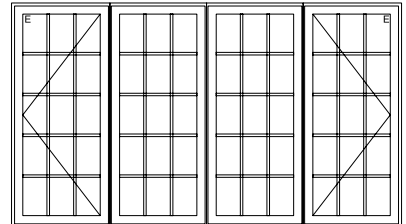

VK4T108062

27" Units (1-2-3-4 sections) cont'd

Dim. Col.
 CADRE
 FRAME
 GLASS
 VERRE

27 3/4"•705mm
 27"•686mm
 20 5/8"•524mm

54 3/4"•1391mm
 54"•1372mm
 21 1/16"•535mm

81 3/4"•2076mm
 81"•2057mm
 21 1/4"•539mm

108 3/4"•2762mm
 108"•2743mm
 21 1/4"•539mm

66 5/8"•1676mm
 66"•1676mm
 59 5/8"•1514mm

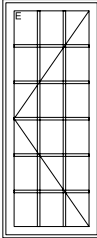

VK1T027066

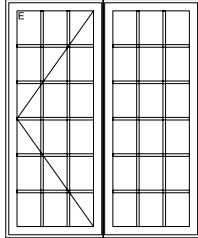

VK2T054066

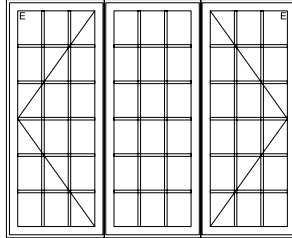

VK3T081066

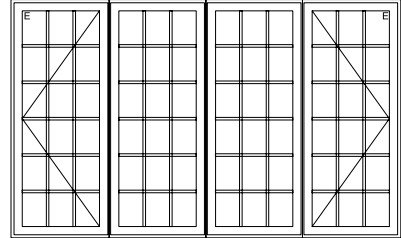

VK4T108066

70 3/4"•1778mm
 70"•1778mm
 63 5/8"•1616mm

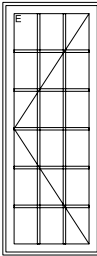

VK1T027070

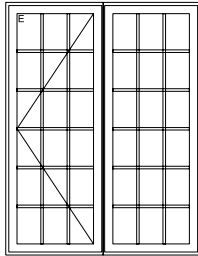

VK2T054070

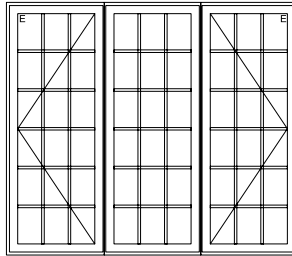

VK3T081070

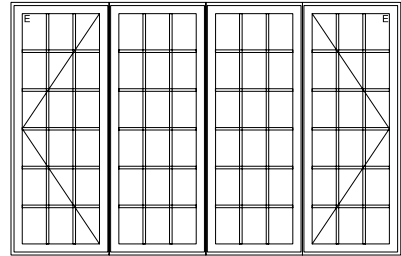

VK4T108070

74 3/4"•1890mm
 74"•1890mm
 67 5/8"•1718mm

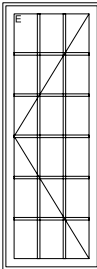

VK1T027074

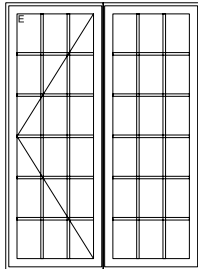

VK2T054074

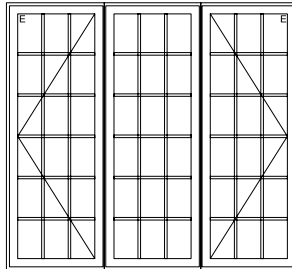

VK3T081074

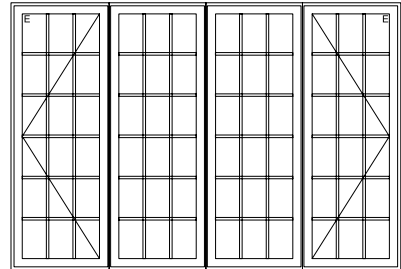

VK4T108074

78 3/4"•1991mm
 78"•1991mm
 71 5/8"•1819mm

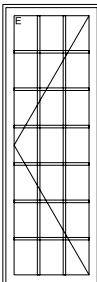

VK1T027078

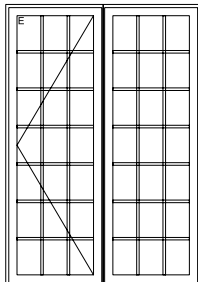

VK2T054078

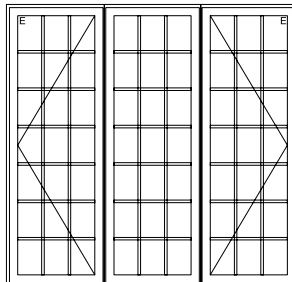

VK3T081078

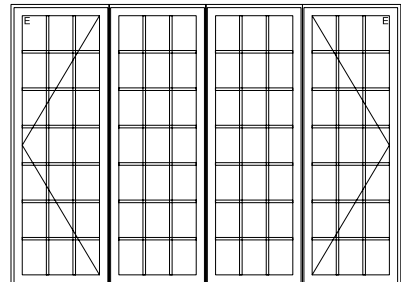

VK4T108078

31" Units (1-2-3 sections)

Dim. Col.
 1650 CADRE
 1650 VERRE

22 5/8" • 569mm
 29" • 736mm
 15 5/8" • 397mm

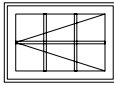

VK1T031022

26 5/8" • 679mm
 26" • 660mm
 19 5/8" • 498mm

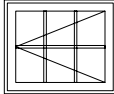

VK1T031026

30 5/8" • 782mm
 30" • 762mm
 23 5/8" • 600mm

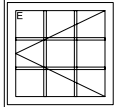

VK1T031030

34 5/8" • 885mm
 34" • 865mm
 27 5/8" • 702mm

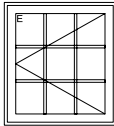

VK1T031034

38 5/8" • 988mm
 38" • 968mm
 29 5/8" • 752mm

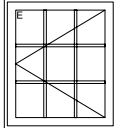

VK1T031036

38 5/8" • 988mm
 38" • 968mm
 31 5/8" • 803mm

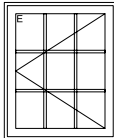

VK1T031038

42 5/8" • 1091mm
 42" • 1067mm
 35 5/8" • 905mm

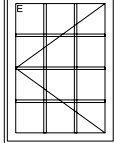

VK1T031042

46 5/8" • 1194mm
 46" • 1169mm
 39 5/8" • 1006mm

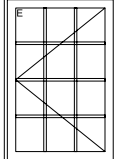

VK1T031046

62 3/4" • 1594mm
 62" • 1575mm
 25 1/16" • 637mm

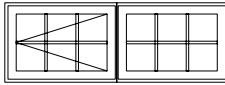

VK2T062022

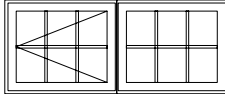

VK2T062026

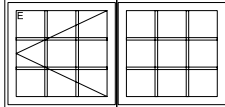

VK2T062030

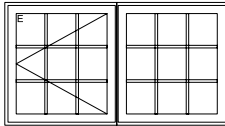

VK2T062034

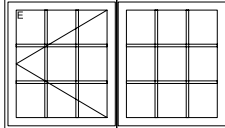

VK2T062036

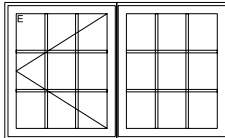

VK2T062038

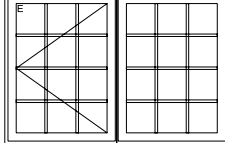

VK2T062042

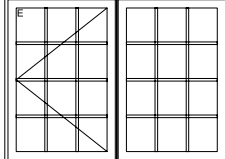

VK2T062046

93 3/4" • 2381mm
 93" • 2362mm
 25 1/4" • 641mm

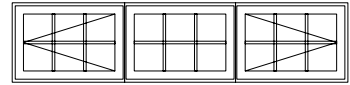

VK3T093022

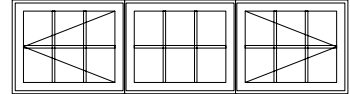

VK3T093026

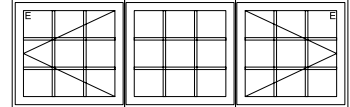

VK3T093030

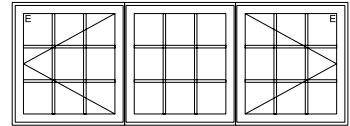

VK3T093034

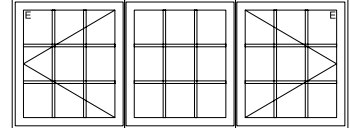

VK3T093036

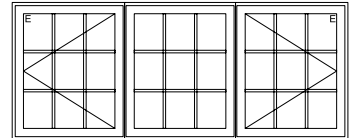

VK3T093038

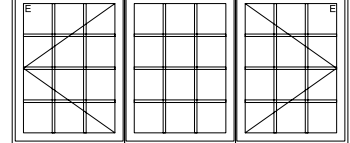

VK3T093042

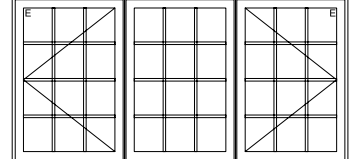

VK3T093046

31" Units (1-2-3 sections) cont'd

NO
 DIM. C.A.
 FRAME CADRE
 GLASS VERRE

31 3/4" • 806mm
 31" • 787mm
 24 5/8" • 625mm

62 3/4" • 1594mm
 62" • 1575mm
 25 1/16" • 637mm

93 3/4" • 2381mm
 93" • 2362mm
 25 1/4" • 641mm

49 3/4" • 1257mm
 48" • 1219mm
 41 5/8" • 1057mm

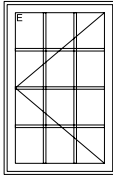

VK1T031048

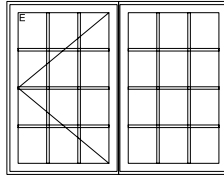

VK2T062048

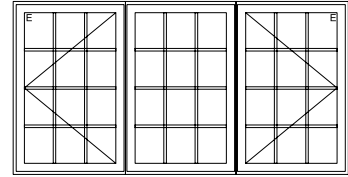

VK3T093048

50 3/4" • 1289mm
 50" • 1270mm
 43 5/8" • 1108mm

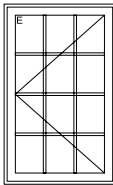

VK1T031050

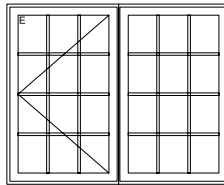

VK2T062050

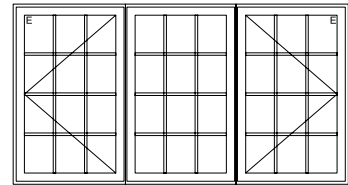

VK3T093050

52 3/4" • 1341mm
 52" • 1322mm
 47 5/8" • 1210mm

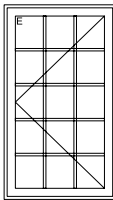

VK1T031054

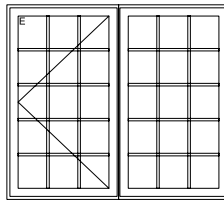

VK2T062054

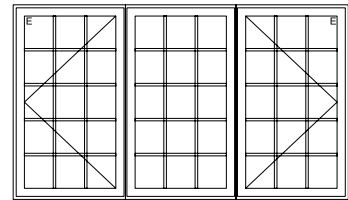

VK3T093054

56 3/4" • 1437mm
 56" • 1418mm
 51 5/8" • 1311mm

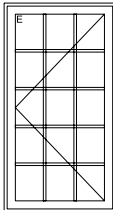

VK1T031058

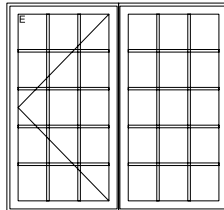

VK2T062058

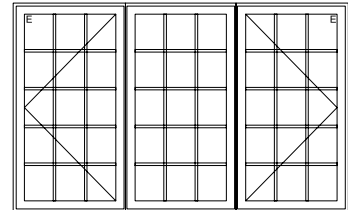

VK3T093058

60 3/4" • 1533mm
 60" • 1514mm
 53 5/8" • 1362mm

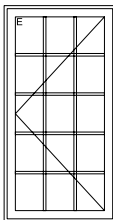

VK1T031060

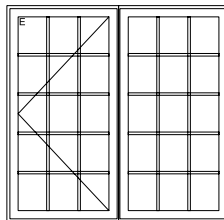

VK2T062060

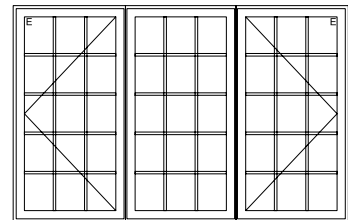

VK3T093060

62 3/4" • 1585mm
 62" • 1566mm
 55 5/8" • 1413mm

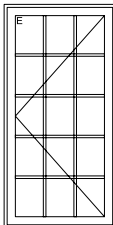

VK1T031062

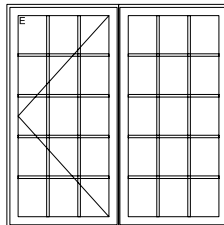

VK2T062062

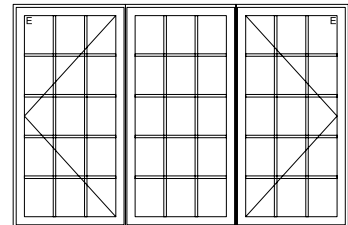

VK3T093062

31" Units (1-2-3 sections) cont'd

Dim.Col.
 CADRE
 FRAME
 GLASS
 VERRE

31 3/4"•806mm
 31"•787mm
 24 5/8"•625mm

62 3/4"•1594mm
 62"•1575mm
 25 1/16"•637mm

93 3/4"•2381mm
 93"•2362mm
 25 1/4"•641mm

66 5/8"•1689mm
 66"•1676mm
 59 5/8"•1514mm

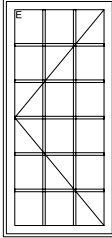

VK1T031066

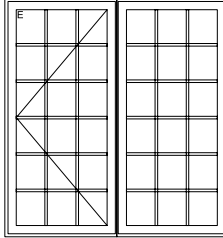

VK2T062066

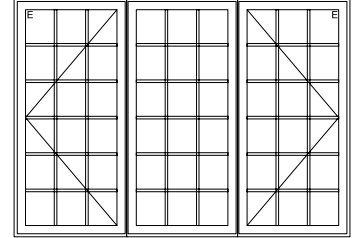

VK3T093066

70 5/8"•1789mm
 70"•1776mm
 63 5/8"•1616mm

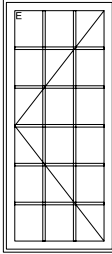

VK1T031070

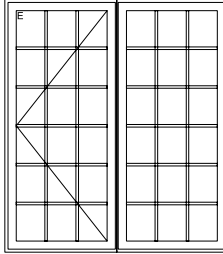

VK2T062070

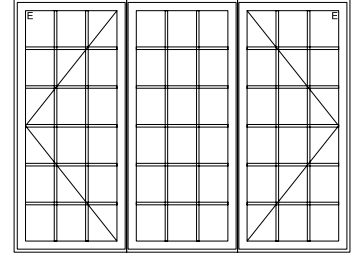

VK3T093070

74 5/8"•1894mm
 74"•1881mm
 67 5/8"•1718mm

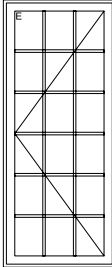

VK1T031074

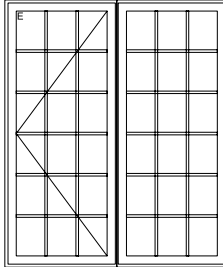

VK2T062074

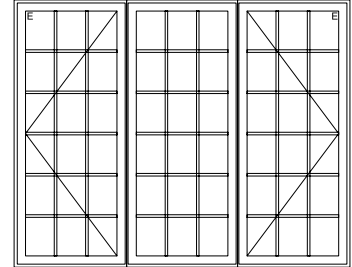

VK3T093074

78 5/8"•1999mm
 78"•1986mm
 71 5/8"•1819mm

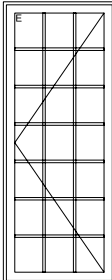

VK1T031078

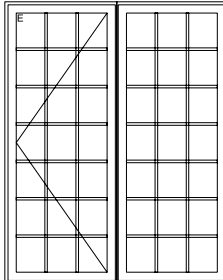

VK2T062078

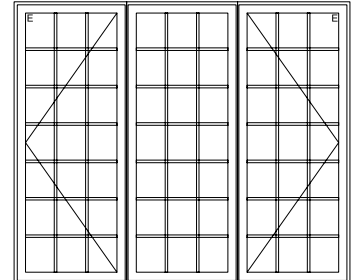

VK3T093078

31" Units (4 sections)

124 3/4" • 3169mm
 124" • 3150mm
 25 1/4" • 642mm

125
 124
 123
 122
 121
 120
 119
 118
 117
 116
 115
 114
 113
 112
 111
 110
 109
 108
 107
 106
 105
 104
 103
 102
 101
 100
 99
 98
 97
 96
 95
 94
 93
 92
 91
 90
 89
 88
 87
 86
 85
 84
 83
 82
 81
 80
 79
 78
 77
 76
 75
 74
 73
 72
 71
 70
 69
 68
 67
 66
 65
 64
 63
 62
 61
 60
 59
 58
 57
 56
 55
 54
 53
 52
 51
 50
 49
 48
 47
 46
 45
 44
 43
 42
 41
 40
 39
 38
 37
 36
 35
 34
 33
 32
 31
 30
 29
 28
 27
 26
 25
 24
 23
 22
 21
 20
 19
 18
 17
 16
 15
 14
 13
 12
 11
 10
 9
 8
 7
 6
 5
 4
 3
 2
 1

22 3/4" • 576mm
 22" • 559mm
 15 5/8" • 397mm

26 3/4" • 679mm
 26" • 662mm
 19 5/8" • 498mm

30 3/4" • 781mm
 30" • 764mm
 23 5/8" • 600mm

34 3/4" • 883mm
 34" • 866mm
 27 5/8" • 702mm

36 3/4" • 933mm
 36" • 916mm
 29 5/8" • 752mm

38 3/4" • 984mm
 38" • 967mm
 31 5/8" • 803mm

42 3/4" • 1086mm
 42" • 1069mm
 35 5/8" • 905mm

46 3/4" • 1187mm
 46" • 1170mm
 39 5/8" • 1007mm

VK4T124022

VK4T124026

VK4T124030

VK4T124034

VK4T124036

VK4T124038

VK4T124042

VK4T124046

124 3/4" • 3169mm
 124" • 3150mm
 25 1/4" • 642mm

125
 124
 123
 122
 121
 120
 119
 118
 117
 116
 115
 114
 113
 112
 111
 110
 109
 108
 107
 106
 105
 104
 103
 102
 101
 100
 99
 98
 97
 96
 95
 94
 93
 92
 91
 90
 89
 88
 87
 86
 85
 84
 83
 82
 81
 80
 79
 78
 77
 76
 75
 74
 73
 72
 71
 70
 69
 68
 67
 66
 65
 64
 63
 62
 61
 60
 59
 58
 57
 56
 55
 54
 53
 52
 51
 50
 49
 48
 47
 46
 45
 44
 43
 42
 41
 40
 39
 38
 37
 36
 35
 34
 33
 32
 31
 30
 29
 28
 27
 26
 25
 24
 23
 22
 21
 20
 19
 18
 17
 16
 15
 14
 13
 12
 11
 10
 9
 8
 7
 6
 5
 4
 3
 2
 1

48 3/4" • 1238mm
 48" • 1221mm
 41 5/8" • 1057mm

50 3/4" • 1289mm
 50" • 1270mm
 43 5/8" • 1108mm

54 3/4" • 1391mm
 54" • 1372mm
 47 5/8" • 1210mm

58 3/4" • 1492mm
 58" • 1473mm
 51 5/8" • 1311mm

60 3/4" • 1543mm
 60" • 1524mm
 53 5/8" • 1362mm

62 3/4" • 1594mm
 62" • 1573mm
 55 5/8" • 1413mm

VK4T124048

VK4T124050

VK4T124054

VK4T124058

VK4T124060

VK4T124062

31" Units (4 sections) cont'd

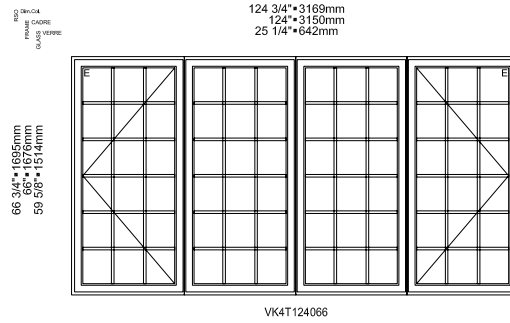

35" Units (1-2-3 sections)

35 3/4" • 908mm
 22 3/4" • 576mm
 15 5/8" • 397mm

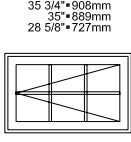

VK1T035022

26 3/4" • 679mm
 19 5/8" • 488mm

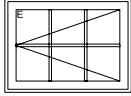

VK1T035026

30 3/4" • 781mm
 23 5/8" • 600mm

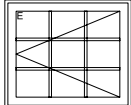

VK1T035030

34 3/4" • 883mm
 27 5/8" • 702mm

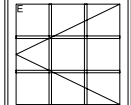

VK1T035034

36 3/4" • 933mm
 29 5/8" • 752mm

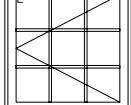

VK1T035036

38 3/4" • 984mm
 31 5/8" • 803mm

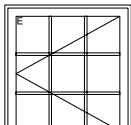

VK1T035038

42 3/4" • 1086mm
 35 5/8" • 905mm

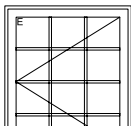

VK1T035042

46 3/4" • 1187mm
 39 5/8" • 1006mm

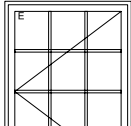

VK1T035046

70 3/4" • 1797mm
 70" • 1778mm
 29 1/16" • 738mm

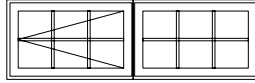

VK2T070022

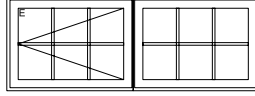

VK2T070026

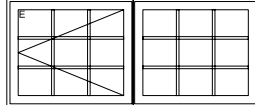

VK2T070030

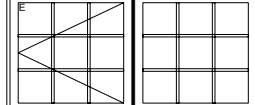

VK2T070034

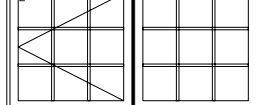

VK2T070036

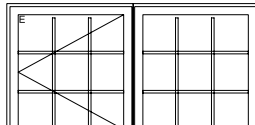

VK2T070038

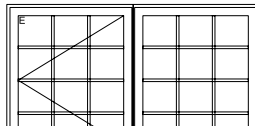

VK2T070042

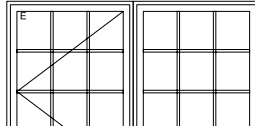

VK2T070046

105 3/4" • 2689mm
 105" • 2667mm
 29 1/4" • 742mm



VK3T105022

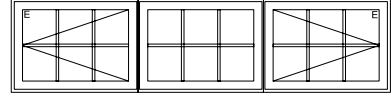

VK3T105026

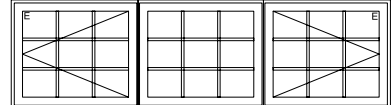

VK3T105030

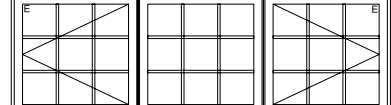

VK3T105034

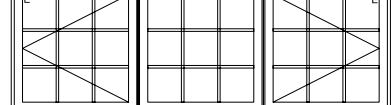

VK3T105036

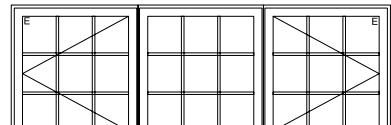

VK3T105038

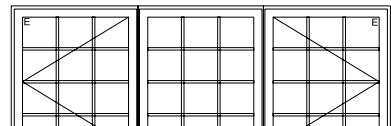

VK3T105042

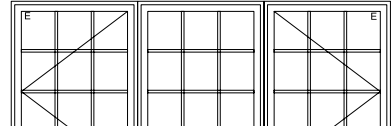

VK3T105046

35" Units (1-2-3 sections) cont'd

03
 04
 05
 06
 07
 08
 09
 10
 11
 12
 13
 14
 15
 16
 17
 18
 19
 20
 21
 22
 23
 24
 25
 26
 27
 28
 29
 30
 31
 32
 33
 34
 35
 36
 37
 38
 39
 40
 41
 42
 43
 44
 45
 46
 47
 48
 49
 50
 51
 52
 53
 54
 55
 56
 57
 58
 59
 60
 61
 62
 63
 64
 65
 66
 67
 68
 69
 70
 71
 72
 73
 74
 75
 76
 77
 78
 79
 80
 81
 82
 83
 84
 85
 86
 87
 88
 89
 90
 91
 92
 93
 94
 95
 96
 97
 98
 99
 100

35 3/4" • 908mm
 35" • 889mm
 28 5/8" • 727mm

48 3/4" • 1238mm
 41 5/8" • 1057mm

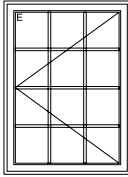

VK1T035048

70 3/4" • 1797mm
 70" • 1778mm
 29 1/16" • 738mm

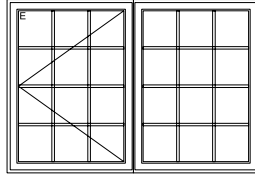

VK2T070048

105 3/4" • 2688mm
 105" • 2667mm
 29 1/4" • 742mm

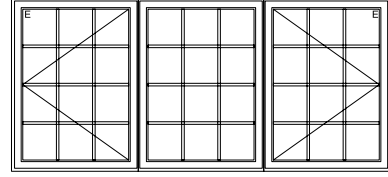

VK3T105048

50 3/4" • 1289mm
 43 5/8" • 1108mm

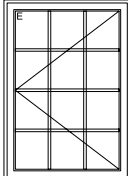

VK1T035050

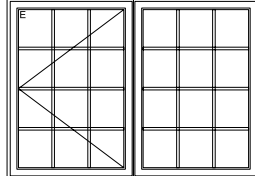

VK2T070050

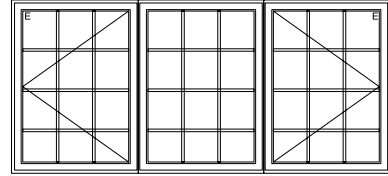

VK3T105050

54 3/4" • 1391mm
 47 5/8" • 1201mm

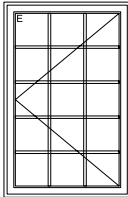

VK1T035054

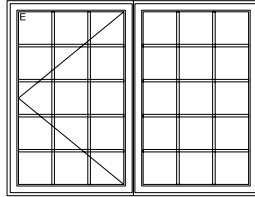

VK2T070054

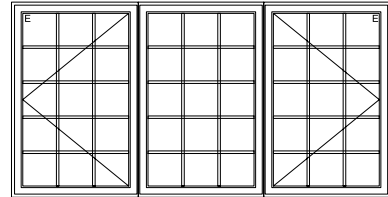

VK3T105054

56 3/4" • 1432mm
 51 5/8" • 1311mm

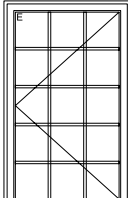

VK1T035058

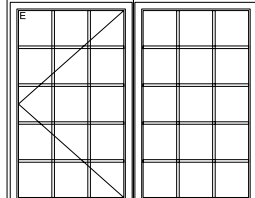

VK2T070058

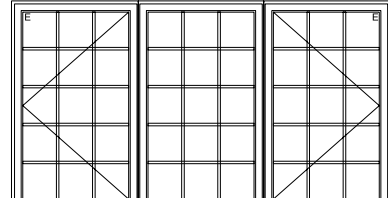

VK3T105058

60 3/4" • 1523mm
 53 5/8" • 1362mm

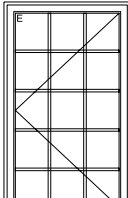

VK1T035060

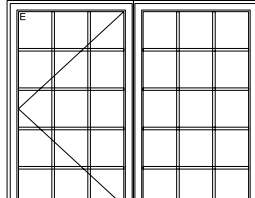

VK2T070060

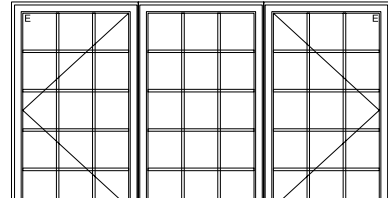

VK3T105060

62 3/4" • 1594mm
 55 5/8" • 1413mm

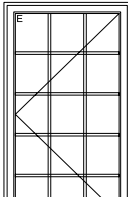

VK1T035062

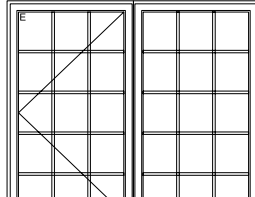

VK2T070062

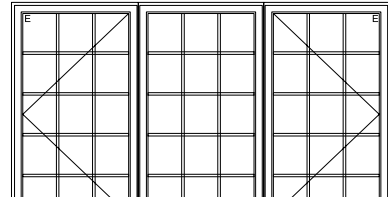

VK3T105062

35" Units (1-2-3 sections) cont'd

FINISH
 FRAME
 GLASS

35 3/4" • 908mm
 35" • 893mm
 28 5/8" • 727mm

66 3/4" • 1695mm
 66" • 1678mm
 59 5/8" • 1514mm

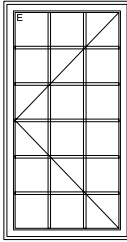

VK1T035066

70 3/4" • 1797mm
 70" • 1778mm
 63 5/8" • 1616mm

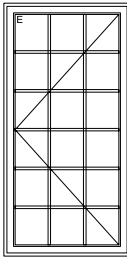

VK1T035070

74 3/4" • 1899mm
 74" • 1880mm
 67 5/8" • 1718mm

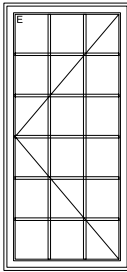

VK1T035074

70 3/4" • 1797mm
 70" • 1778mm
 29 1/16" • 738mm

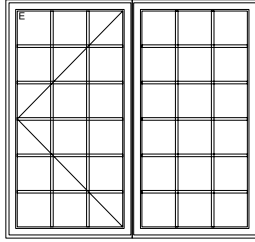

VK2T070066

70 3/4" • 1797mm
 70" • 1778mm
 29 1/16" • 738mm

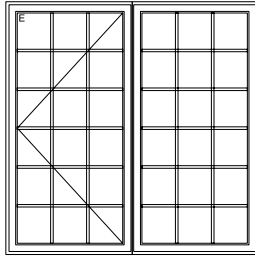

VK2T070070

70 3/4" • 1797mm
 70" • 1778mm
 29 1/16" • 738mm

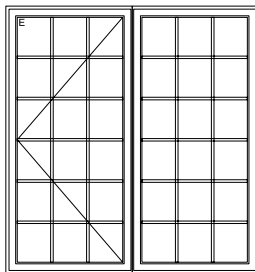

VK2T070074

105 3/4" • 2686mm
 105" • 2667mm
 29 1/4" • 742mm

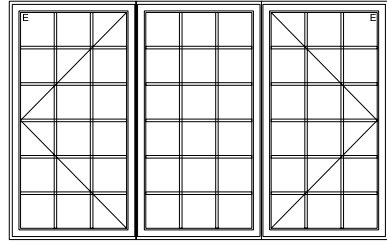

VK3T105066

105 3/4" • 2686mm
 105" • 2667mm
 29 1/4" • 742mm

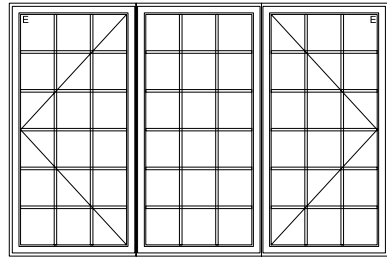

VK3T105070

105 3/4" • 2686mm
 105" • 2667mm
 29 1/4" • 742mm

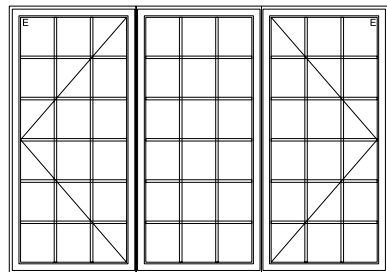

VK3T105074

36" Units (1-2-3 sections)

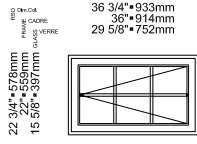

VK1T036022

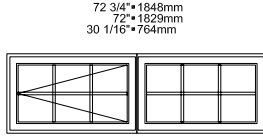

VK2T072022

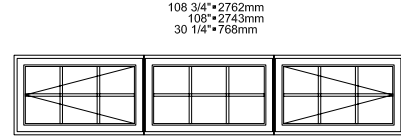

VK3T108022

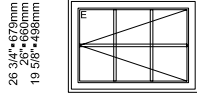

VK1T036026

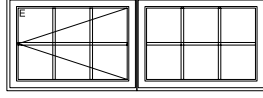

VK2T072026

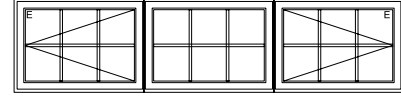

VK3T108026

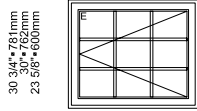

VK1T036030

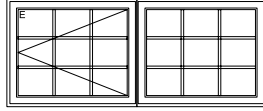

VK2T072030

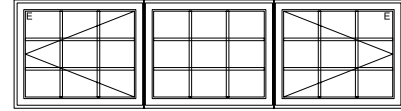

VK3T108030

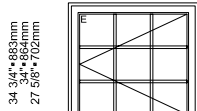

VK1T036034

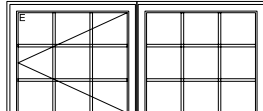

VK2T072034

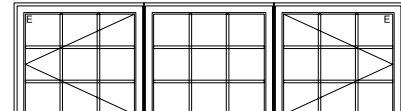

VK3T108034

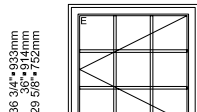

VK1T036036

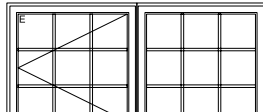

VK2T072036

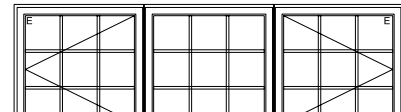

VK3T108036

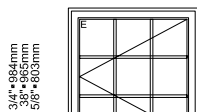

VK1T036038

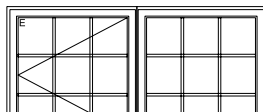

VK2T072038

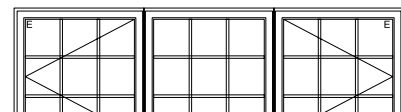

VK3T108038

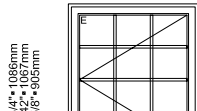

VK1T036042

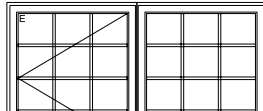

VK2T072042

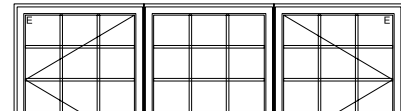

VK3T108042

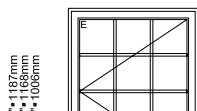

VK1T036046

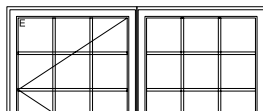

VK2T072046

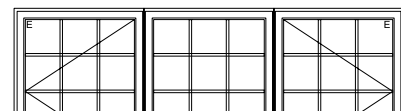

VK3T108046

36" Units (1-2-3 sections) cont'd

PROJ. NO.
 DRAWING NO.
 DATE
 DESIGNED BY
 CHECKED BY

36 3/4" • 933mm
 36" • 914mm
 29 5/8" • 752mm

48 3/4" • 1238mm
 48" • 1219mm
 41 5/8" • 1057mm

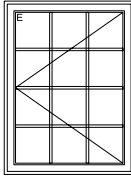

VK1T036048

72 3/4" • 1848mm
 72" • 1829mm
 30 1/16" • 764mm

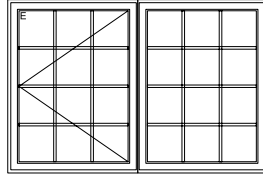

VK2T072048

108 3/4" • 2762mm
 108" • 2743mm
 30 1/4" • 768mm

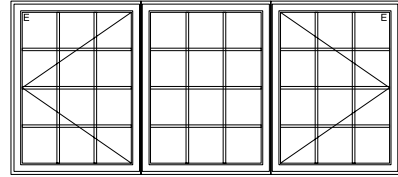

VK3T108048

50 3/4" • 1289mm
 50" • 1270mm
 43 5/8" • 1108mm

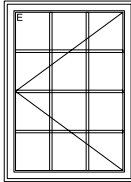

VK1T036050

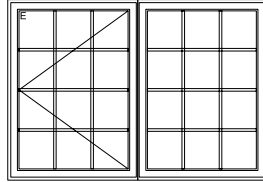

VK2T072050

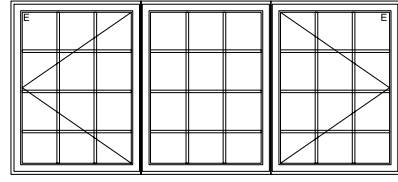

VK3T108050

54 3/4" • 1391mm
 54" • 1372mm
 47 5/8" • 1208mm

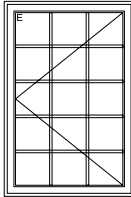

VK1T036054

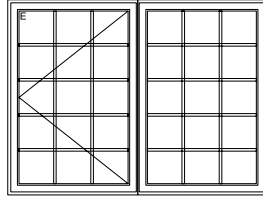

VK2T072054

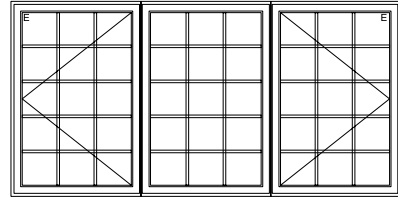

VK3T108054

58 3/4" • 1492mm
 58" • 1473mm
 51 5/8" • 1311mm

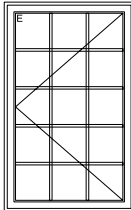

VK1T036058

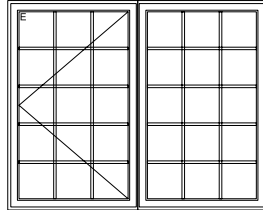

VK2T072058

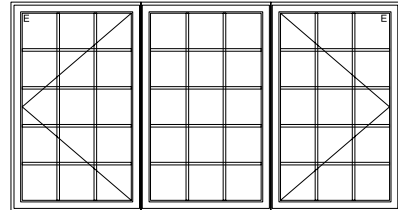

VK3T108058

60 3/4" • 1543mm
 60" • 1524mm
 53 5/8" • 1362mm

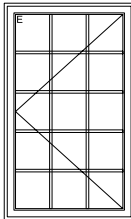

VK1T036060

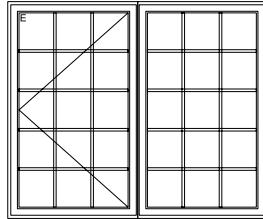

VK2T072060

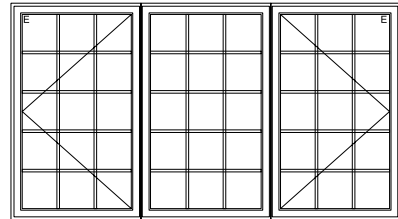

VK3T108060

62 3/4" • 1594mm
 62" • 1575mm
 55 5/8" • 1413mm

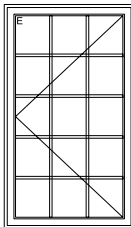

VK1T036062

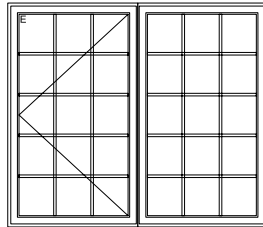

VK2T072062

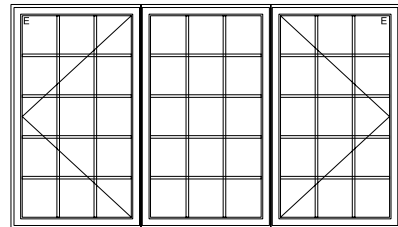

VK3T108062

36" Units (1-2-3 sections) cont'd

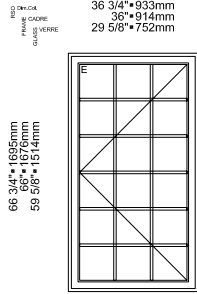

VK1T036066

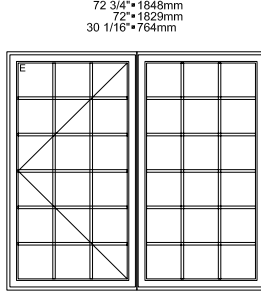

VK2T072066

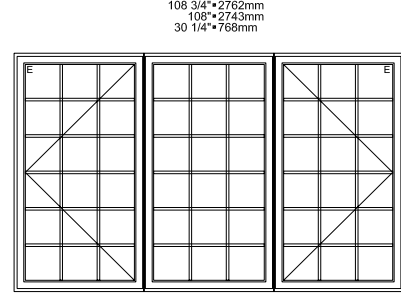

VK3T108066

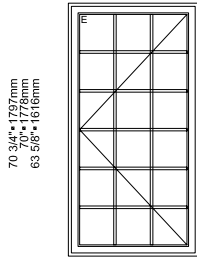

VK1T036070

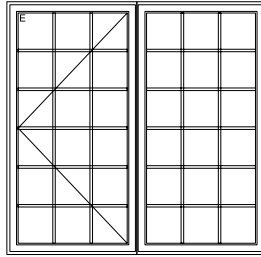

VK2T072070

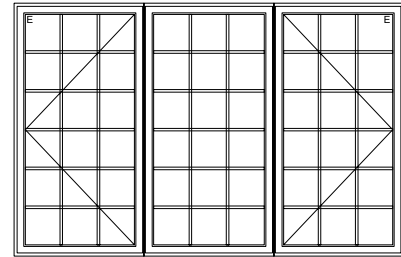

VK3T108070

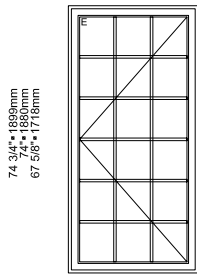

VK1T036074

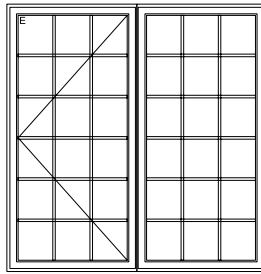

VK2T072074

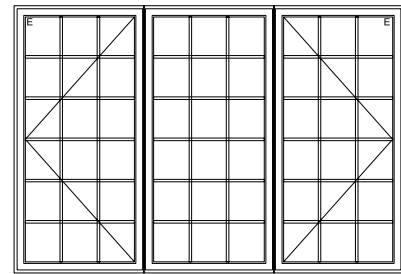

VK3T108074

76" Units (3 uneven sections)

Dim.Col.
RSO
FRAME
CADRE
GLASS
VERRE

76 3/4" • 1949mm
78" • 1930mm
13 3/16" - 32 5/8" - 13 3/16"
335mm-829mm-335mm

22 3/4" • 578mm
22" • 559mm
15 5/8" • 397mm

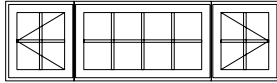

VK3LT076022

26 3/4" • 679mm
26" • 660mm
19 3/8" • 493mm



VK3LT076026

30 3/4" • 781mm
30" • 762mm
23 3/8" • 600mm

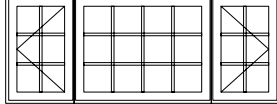

VK3LT076030

34 3/4" • 883mm
34" • 864mm
27 3/8" • 702mm

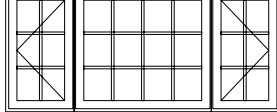

VK3LT076034

36 3/4" • 933mm
36" • 914mm
29 3/8" • 752mm

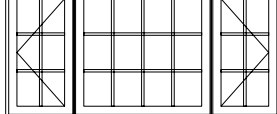

VK3LT076036

38 3/4" • 984mm
38" • 965mm
31 3/8" • 803mm

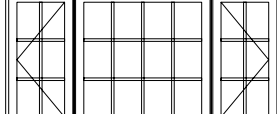

VK3LT076038

42 3/4" • 1086mm
42" • 1067mm
35 3/8" • 903mm

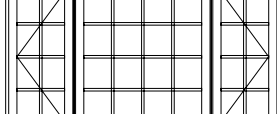

VK3LT076042

46 3/4" • 1187mm
46" • 1168mm
39 3/8" • 1003mm

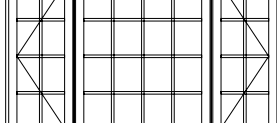

VK3LT076046

Dim.Col.
RSO
FRAME
CADRE
GLASS
VERRE

76 3/4" • 1949mm
78" • 1930mm
13 3/16" - 32 5/8" - 13 3/16"
335mm-829mm-335mm

48 3/4" • 1238mm
48" • 1199mm
41 5/8" • 1057mm

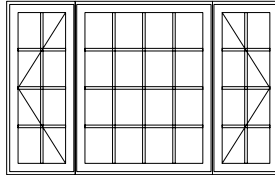

VK3LT076048

50 3/4" • 1299mm
50" • 1270mm
43 5/8" • 1108mm

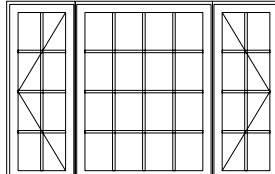

VK3LT076050

54 3/4" • 1391mm
54" • 1372mm
47 5/8" • 1210mm

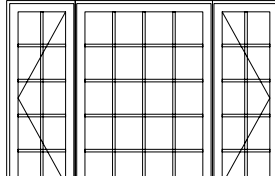

VK3LT076054

56 3/4" • 1452mm
56" • 1433mm
51 5/8" • 1311mm

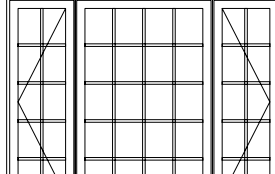

VK3LT076058

60 3/4" • 1544mm
60" • 1525mm
53 5/8" • 1362mm

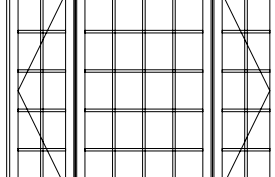

VK3LT076060

62 3/4" • 1584mm
62" • 1575mm
55 5/8" • 1413mm

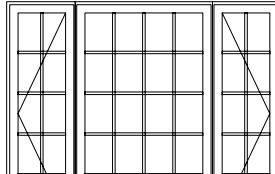

VK3LT076062

Dim.Col.
RSO
FRAME
CADRE
GLASS
VERRE

76 3/4" • 1949mm
78" • 1930mm
13 3/16" - 32 5/8" - 13 3/16"
335mm-829mm-335mm

66 3/4" • 1695mm
66" • 1676mm
59 5/8" • 1514mm

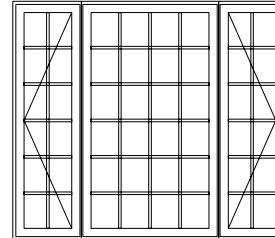

VK3LT076066

70 3/4" • 1797mm
70" • 1778mm
63 5/8" • 1616mm

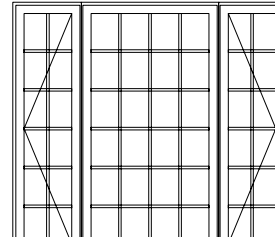

VK3LT076070

74 3/4" • 1899mm
74" • 1880mm
67 5/8" • 1718mm

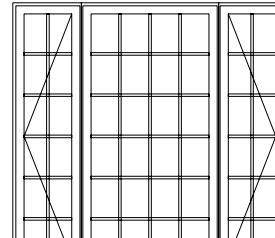

VK3LT076074

78 3/4" • 2000mm
78" • 1981mm
71 5/8" • 1819mm

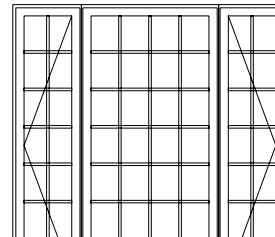

VK3LT076078

Frame: 19" - 38" - 19"
Cadre: 483mm-965mm-483mm

84" Units (3 uneven sections)

Dim.Col. RSO
 CADRE VERRE
 FRAME GLASS
 84 3/4"•2153mm
 84"•2134mm
 13 3/16"- 40 5/8"- 13 3/16"
 335mm-1032mm-335mm

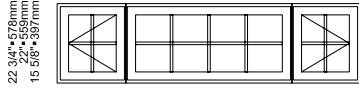

VK3LT084022

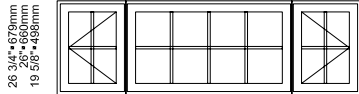

VK3LT084026

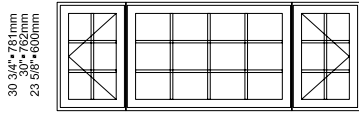

VK3LT084030

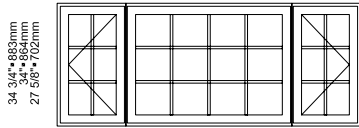

VK3LT084034

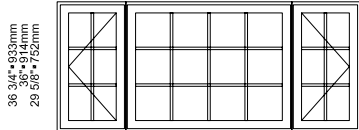

VK3LT084036

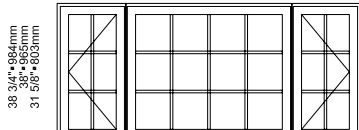

VK3LT084038

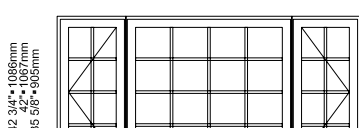

VK3LT084042

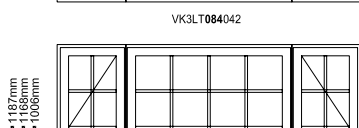

VK3LT084046

Dim.Col. RSO
 CADRE VERRE
 FRAME GLASS
 84 3/4"•2153mm
 84"•2134mm
 13 3/16"- 40 5/8"- 13 3/16"
 335mm-1032mm-335mm

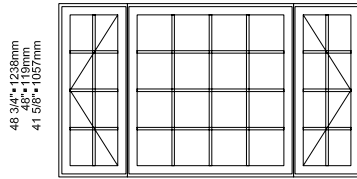

VK3LT084048

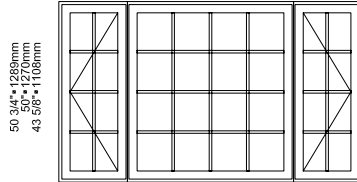

VK3LT084050

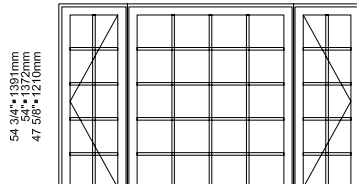

VK3LT084054

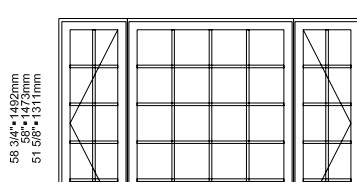

VK3LT084058

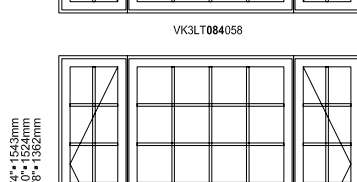

VK3LT084060

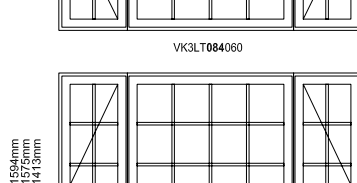

VK3LT084062

Dim.Col. RSO
 CADRE VERRE
 FRAME GLASS
 84 3/4"•2153mm
 84"•2134mm
 13 3/16"- 40 5/8"- 13 3/16"
 335mm-1032mm-335mm

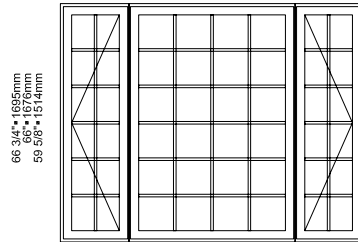

VK3LT084066

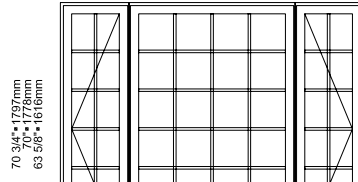

VK3LT084070

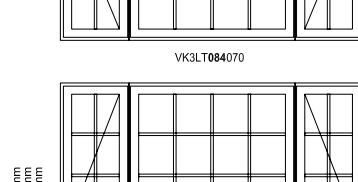



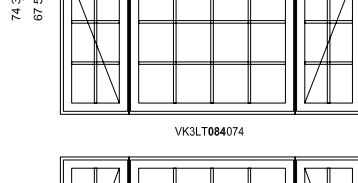



VK3LT084074



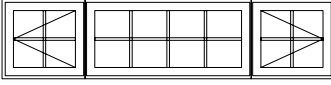
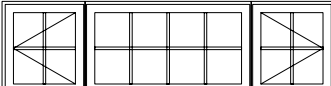



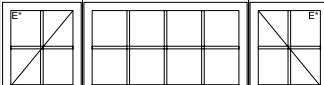

VK3LT084078

Frame: 19"- 46"- 19"
 Cadre: 483mm-1168mm-483mm

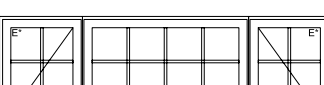
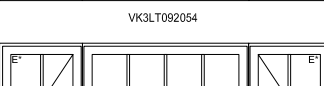
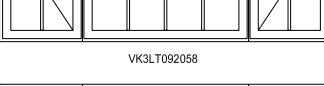
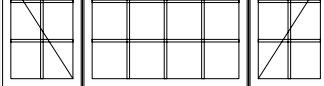
92" Units (3 uneven sections)

REG. CH. CA. FRAME CADRE GLASS VERRRE 22 3/4" • 578mm 22" • 559mm 15 5/8" • 397mm	92 3/4" • 2356mm 92" • 2337mm 17 3/16" - 40 5/8" - 17 3/16" 436mm-1032mm-436mm	 <p>VK3LT092022</p>
26 3/4" • 679mm 26" • 660mm 19 5/8" • 498mm		 <p>VK3LT092026</p>
30 3/4" • 781mm 30" • 762mm 23 5/8" • 600mm		 <p>VK3LT092030</p>
34 3/4" • 883mm 34" • 864mm 27 5/8" • 702mm		 <p>VK3LT092034</p>
36 3/4" • 933mm 36" • 914mm 29 5/8" • 752mm		 <p>VK3LT092036</p>
38 3/4" • 984mm 38" • 965mm 31 5/8" • 803mm		 <p>VK3LT092038</p>
42 3/4" • 1086mm 42" • 1067mm 35 5/8" • 905mm		 <p>VK3LT092042</p>
46 3/4" • 1187mm 46" • 1168mm 39 5/8" • 1006mm		 <p>VK3LT092046</p>

REG. CH. CA. FRAME CADRE GLASS VERRRE 48 3/4" • 1238mm 48" • 1219mm 41 5/8" • 1057mm	92 3/4" • 2356mm 92" • 2337mm 17 3/16" - 40 5/8" - 17 3/16" 436mm-1032mm-436mm	 <p>VK3LT092048</p>
50 3/4" • 1289mm 50" • 1270mm 43 5/8" • 1108mm		 <p>VK3LT092050</p>
54 3/4" • 1391mm 54" • 1372mm 47 5/8" • 1210mm		 <p>VK3LT092054</p>
58 3/4" • 1492mm 58" • 1473mm 51 5/8" • 1311mm		 <p>VK3LT092058</p>
60 3/4" • 1543mm 60" • 1524mm 53 5/8" • 1362mm		 <p>VK3LT092060</p>
62 3/4" • 1594mm 62" • 1575mm 55 5/8" • 1413mm		 <p>VK3LT092062</p>

REG. CH. CA. FRAME CADRE GLASS VERRRE 66 3/4" • 1695mm 66" • 1676mm 59 5/8" • 1514mm	92 3/4" • 2356mm 92" • 2337mm 17 3/16" - 40 5/8" - 17 3/16" 436mm-1032mm-436mm	 <p>VK3LT092066</p>
70 3/4" • 1797mm 70" • 1778mm 63 5/8" • 1616mm		 <p>VK3LT092070</p>
74 3/4" • 1899mm 74" • 1880mm 67 5/8" • 1718mm		 <p>VK3LT092074</p>
78 3/4" • 2000mm 78" • 1981mm 71 5/8" • 1819mm		 <p>VK3LT092078</p>

Frame: 23" - 46" - 23"
 Cadre: 584mm-1168mm-584mm

100 "Units (3 uneven sections)

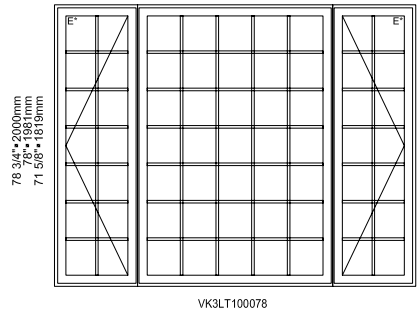
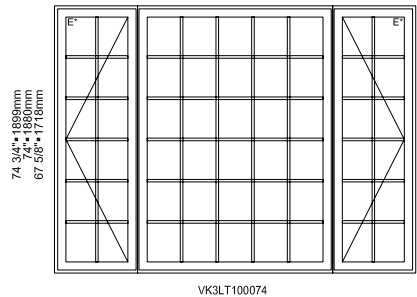
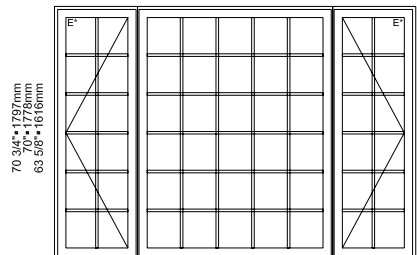
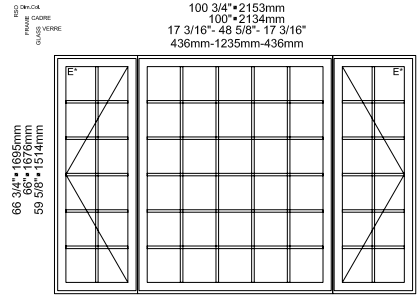
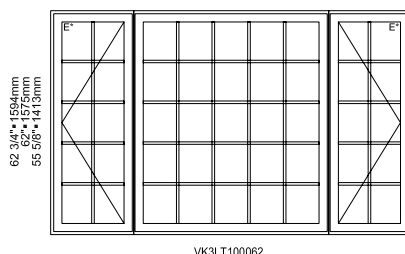
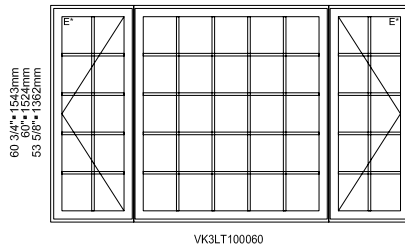
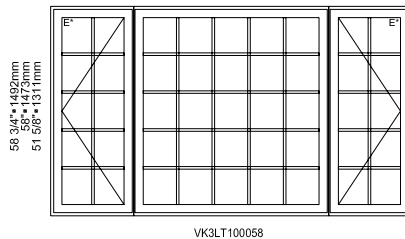
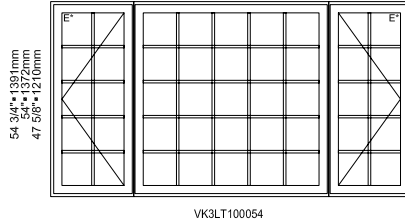
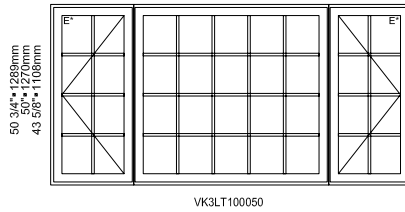
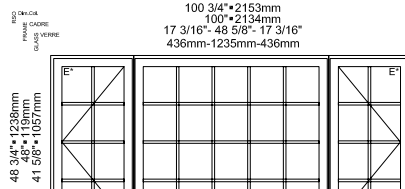
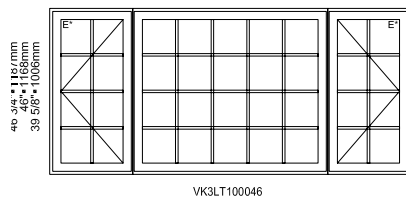
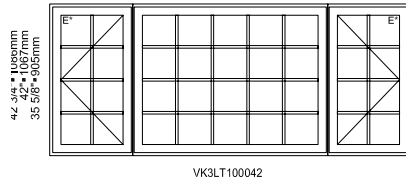
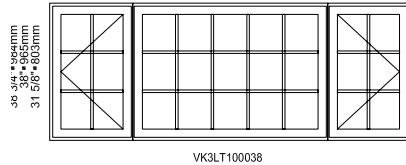
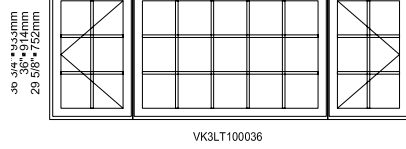
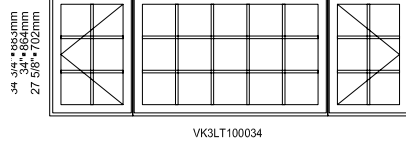
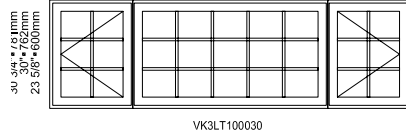
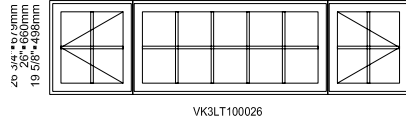
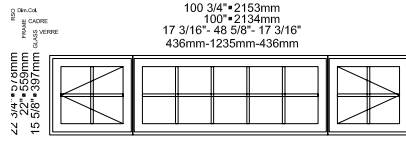

Frame: 23"- 54"- 23"
 Cadre: 584mm-1372mm-584mm

108" Units (3 uneven sections)

Frame: 27"- 54"- 27"
 Cadre: 686mm-1372mm-686mm

Dim. Col.
 CADRE
 FERRE

108 3/4" • 2762mm
 108" • 2743mm
 21 3/16" • 48 5/8" • 21 3/16"
 538mm-1235mm-538mm

44 5/8" • 1130mm
 27" • 686mm
 15 5/8" • 397mm

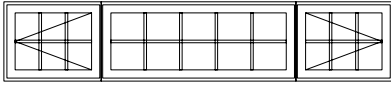

VK3LT108022

40 5/8" • 1030mm
 26" • 660mm
 19 5/8" • 498mm



VK3LT108026

30 5/8" • 770mm
 18" • 457mm
 23 5/8" • 600mm

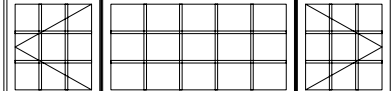

VK3LT108030

34 5/8" • 880mm
 20" • 508mm
 27 5/8" • 702mm



VK3LT108034

30 5/8" • 770mm
 18" • 457mm
 29 5/8" • 752mm



VK3LT108036

36 5/8" • 920mm
 22" • 559mm
 31 5/8" • 803mm

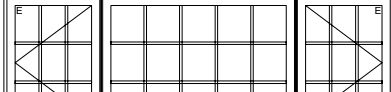

VK3LT108038

44 5/8" • 1130mm
 27" • 686mm
 35 5/8" • 905mm



VK3LT108042

40 5/8" • 1030mm
 26" • 660mm
 39 5/8" • 1006mm



VK3LT108046

Dim. Col.
 CADRE
 FERRE

108 3/4" • 2762mm
 108" • 2743mm
 21 3/16" • 48 5/8" • 21 3/16"
 538mm-1235mm-538mm

48 3/4" • 1238mm
 48" • 1219mm
 41 5/8" • 1057mm

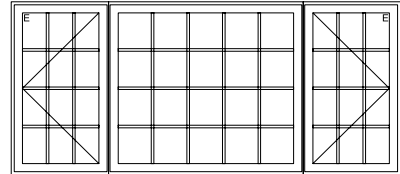

VK3LT108048

50 3/4" • 1289mm
 50" • 1270mm
 43 5/8" • 1108mm

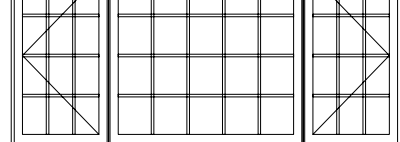

VK3LT108050

54 3/4" • 1381mm
 54" • 1372mm
 47 5/8" • 1210mm

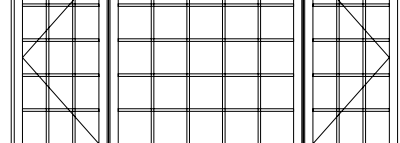

VK3LT108054

58 3/4" • 1492mm
 58" • 1473mm
 51 5/8" • 1311mm

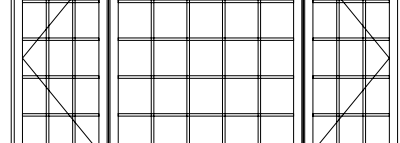

VK3LT108058

60 3/4" • 1543mm
 60" • 1524mm
 53 5/8" • 1362mm

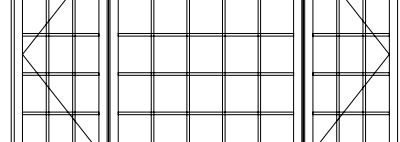

VK3LT108060

62 3/4" • 1594mm
 62" • 1575mm
 55 5/8" • 1413mm

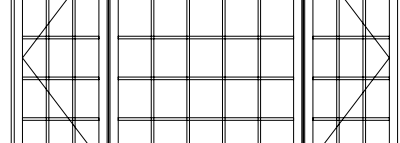

VK3LT108062

108" Units (3 uneven sections) cont'd

Frame: 27"- 54"- 27"
 Cadre: 686mm-1372mm-686mm

Dim.-Col.
 CADRE
 FRAME
 VERRE
 GLASS

108 3/4" • 2762mm
 108" • 2743mm
 21 3/16" • 48 5/8" • 21 3/16"
 538mm • 1235mm • 538mm

66 3/4" • 1695mm
 66" • 1676mm
 59 5/8" • 1514mm

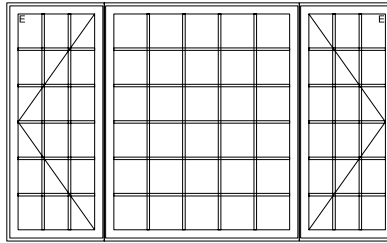

VK3LT108066

70 3/4" • 1797mm
 70" • 1778mm
 63 5/8" • 1616mm

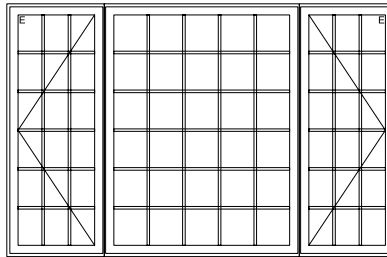

VK3LT108070

74 3/4" • 1899mm
 74" • 1880mm
 67 5/8" • 1718mm

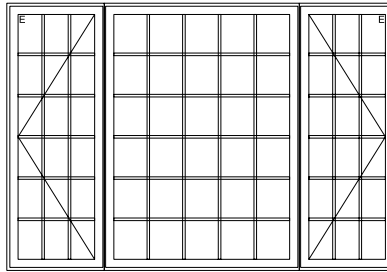

VK3LT108074

78 3/4" • 2000mm
 78" • 1981mm
 71 5/8" • 1819mm

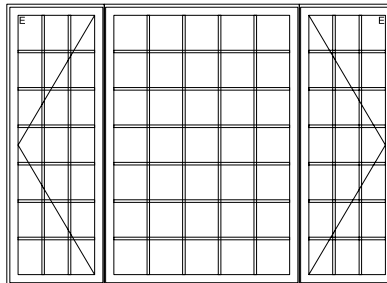

VK3LT108078

116" Units (3 uneven sections)

Frame: 27"- 62"- 27"
 Cadre: 686mm-1575mm-686mm

Dim. Co.
 CADRE
 VERRE

116 3/4"•2965mm
 116"•2946mm
 21 3/16"• 56 5/8"• 21 3/16"
 538mm-1439mm-538mm

22 2/3"• 569mm
 22"• 559mm
 15 5/8"• 397mm

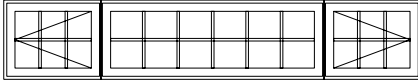

VK3LT116022

24 5/8"• 617mm
 24"• 607mm
 19 5/8"• 498mm



VK3LT116026

30 5/8"• 771mm
 30"• 762mm
 23 5/8"• 600mm

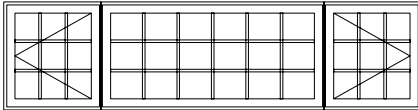

VK3LT116030

34 3/8"• 864mm
 34"• 854mm
 27 5/8"• 702mm

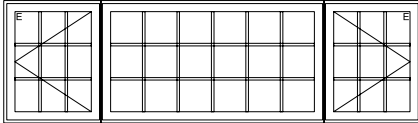

VK3LT116034

36 5/8"• 917mm
 36"• 914mm
 29 5/8"• 752mm

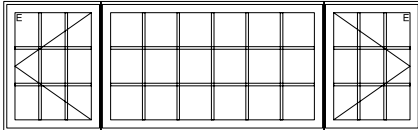

VK3LT116036

38 5/8"• 985mm
 38"• 965mm
 31 5/8"• 803mm

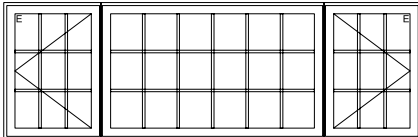

VK3LT116038

42 5/8"• 1087mm
 42"• 1067mm
 35 5/8"• 903mm

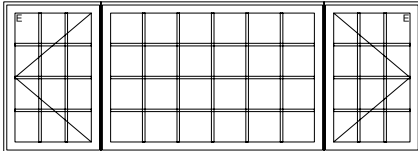

VK3LT116042

46 5/8"• 1189mm
 46"• 1169mm
 39 5/8"• 1006mm

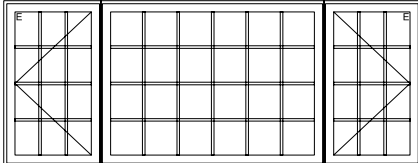

VK3LT116046

Dim. Co.
 CADRE
 VERRE

116 3/4"•2965mm
 116"•2946mm
 21 3/16"• 56 5/8"• 21 3/16"
 538mm-1439mm-538mm

48 3/4"• 1238mm
 48"• 1219mm
 41 5/8"• 1057mm

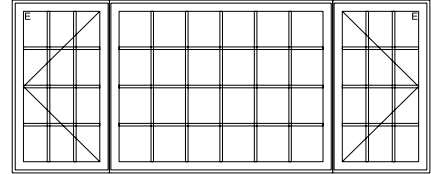

VK3LT116048

50 3/4"• 1280mm
 50"• 1270mm
 43 5/8"• 1108mm

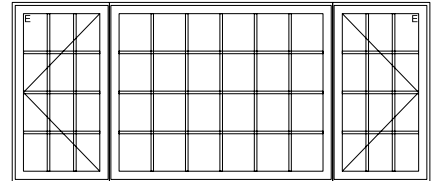

VK3LT116050

54 3/4"• 1391mm
 54"• 1372mm
 47 5/8"• 1210mm

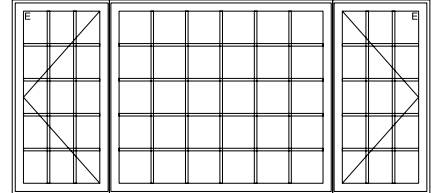

VK3LT116054

58 3/4"• 1492mm
 58"• 1473mm
 51 5/8"• 1311mm

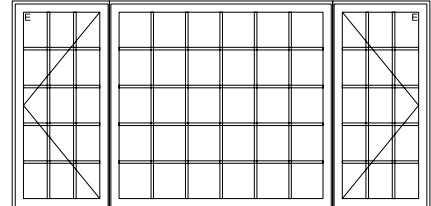

VK3LT116058

60 3/4"• 1543mm
 60"• 1524mm
 53 5/8"• 1362mm

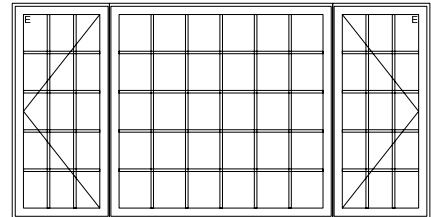

VK3LT116060

62 3/4"• 1594mm
 62"• 1575mm
 55 5/8"• 1413mm

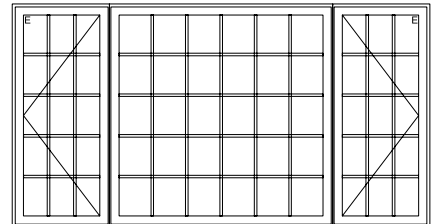

VK3LT116062

116" Units (3 uneven sections) cont'd

Frame: 27"- 62"- 27"
 Cadre: 686mm-1575mm-686mm

Dim.Col.
 CADRE
 FRAME
 GLASS
 VERRE

116 3/4" • 2965mm
 116" • 2946mm
 21 3/16" • 56 5/8" • 21 3/16"
 538mm • 1439mm • 538mm

66 3/4" • 1695mm
 66" • 1676mm
 59 5/8" • 1514mm

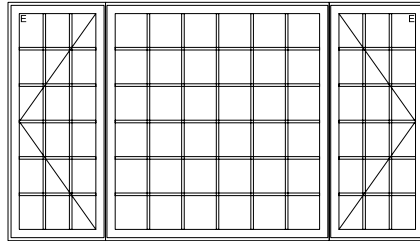

VK3LT116066

70 3/4" • 1797mm
 70" • 1778mm
 63 5/8" • 1616mm

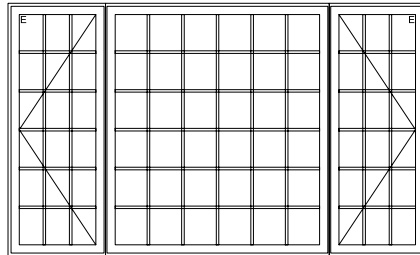

VK3LT116070

74 3/4" • 1899mm
 74" • 1880mm
 67 5/8" • 1718mm

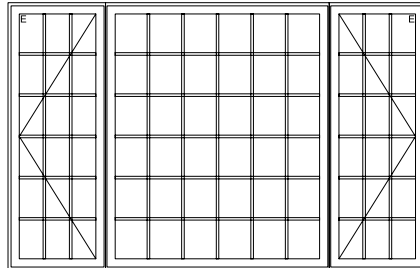

VK3LT116074

124" Units (3 uneven sections)

Frame: 31"- 62"- 31"
 Cadre: 787mm-1575mm-787mm

Unit Dim Col
 FRAME CADRE
 GLASS VERRE

22 3/4" • 581mm
 22" • 559mm
 15 5/8" • 397mm

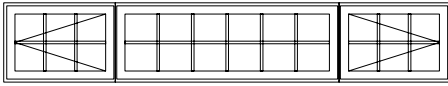

VK3LT124022

29 3/4" • 757mm
 29" • 737mm
 19 5/8" • 498mm

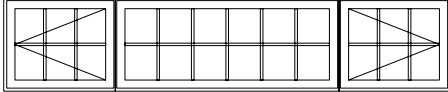

VK3LT124026

30 3/4" • 781mm
 30" • 762mm
 23 5/8" • 600mm

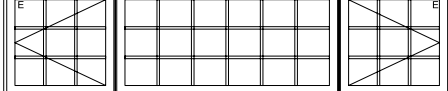

VK3LT124030

34 3/4" • 887mm
 34" • 864mm
 27 5/8" • 702mm



VK3LT124034

36 3/4" • 931mm
 36" • 914mm
 29 5/8" • 752mm



VK3LT124036

36 3/4" • 931mm
 36" • 914mm
 31 5/8" • 803mm



VK3LT124038

42 3/4" • 1097mm
 42" • 1057mm
 35 5/8" • 905mm



VK3LT124042

49 3/4" • 1263mm
 49" • 1189mm
 39 5/8" • 1006mm



VK3LT124046

49 3/4" • 1263mm
 48" • 1219mm
 41 5/8" • 1057mm



VK3LT124048

124 3/4" • 3169mm
 124" • 3150mm
 25 3/16" • 56 5/8" • 25 3/16"
 639mm-1439mm-639mm

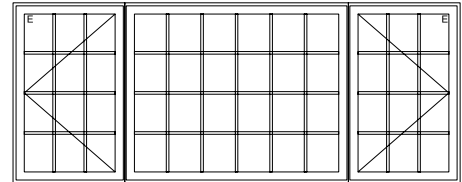

VK3LT124050

50 3/4" • 1289mm
 50" • 1270mm
 43 5/8" • 1108mm

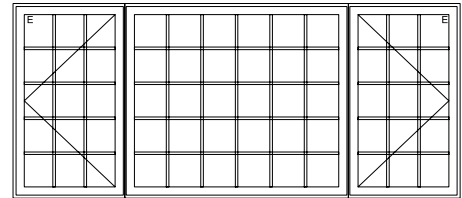

VK3LT124054

54 3/4" • 1391mm
 54" • 1372mm
 47 5/8" • 1210mm

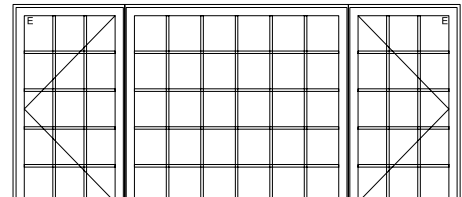

VK3LT124058

58 3/4" • 1492mm
 58" • 1473mm
 51 5/8" • 1311mm

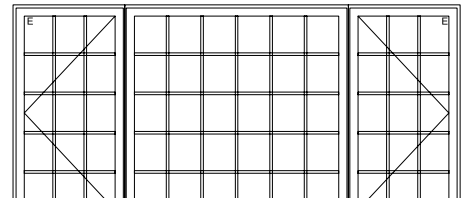

VK3LT124060

60 3/4" • 1543mm
 60" • 1524mm
 53 5/8" • 1362mm

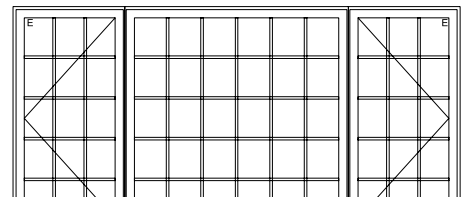

VK3LT124062

62 3/4" • 1594mm
 62" • 1575mm
 55 5/8" • 1413mm

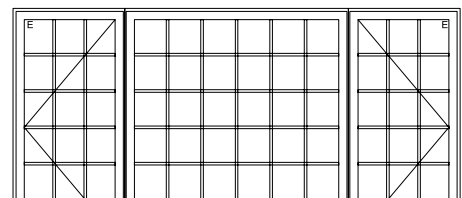

VK3LT124066

76" Units (30° Bay)

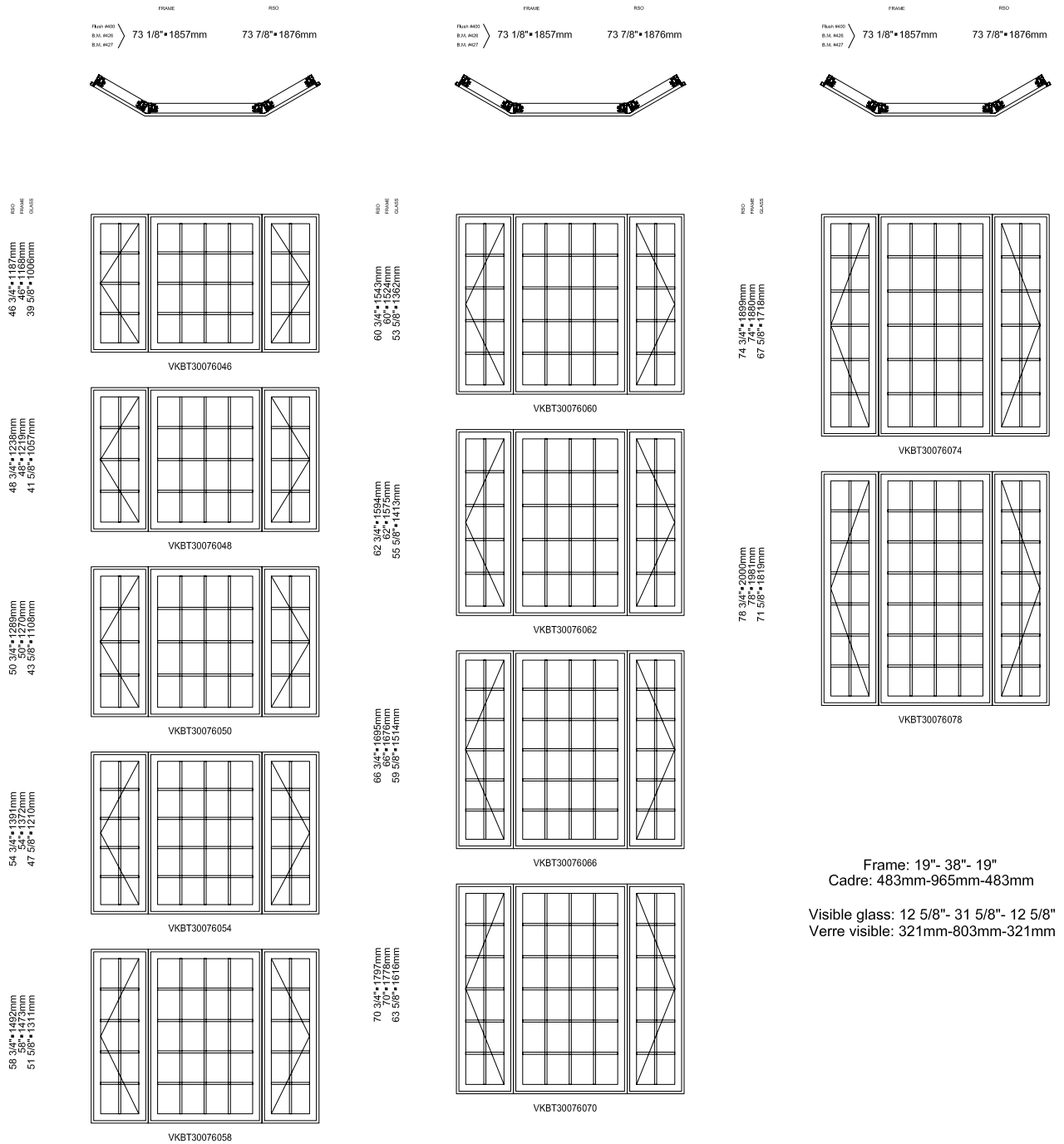

84" Units (30° Bay)

<p>FRAME RSD</p> <p>FRAM. HEIGHT 81 1/8" • 2061mm R.S.D. HEIGHT 81 7/8" • 2080mm</p>	<p>FRAME RSD</p> <p>FRAM. HEIGHT 81 1/8" • 2061mm R.S.D. HEIGHT 81 7/8" • 2080mm</p>	<p>FRAME RSD</p> <p>FRAM. HEIGHT 81 1/8" • 2061mm R.S.D. HEIGHT 81 7/8" • 2080mm</p>
<p>ROD FRAME GLASS</p> <p>46 3/4" • 1187mm 46" • 1168mm 39 5/8" • 1006mm</p> <p>VKBT30084046</p>	<p>ROD FRAME GLASS</p> <p>60 3/4" • 1523mm 53 5/8" • 1362mm</p> <p>VKBT30084060</p>	<p>ROD FRAME GLASS</p> <p>74 3/4" • 1899mm 74" • 1880mm 67 5/8" • 1718mm</p> <p>VKBT30084074</p>
<p>ROD FRAME GLASS</p> <p>48 3/4" • 1236mm 48" • 1191mm 41 5/8" • 1057mm</p> <p>VKBT30084048</p>	<p>ROD FRAME GLASS</p> <p>62 3/4" • 1594mm 55 5/8" • 1413mm</p> <p>VKBT30084062</p>	<p>ROD FRAME GLASS</p> <p>78 3/4" • 2000mm 78" • 1981mm 71 5/8" • 1819mm</p> <p>VKBT30084078</p>
<p>ROD FRAME GLASS</p> <p>50 3/4" • 1289mm 50" • 1270mm 43 5/8" • 1108mm</p> <p>VKBT30084050</p>	<p>ROD FRAME GLASS</p> <p>66 3/4" • 1692mm 59 5/8" • 1514mm</p> <p>VKBT30084066</p>	<p>ROD FRAME GLASS</p> <p>78 3/4" • 2000mm 78" • 1981mm 71 5/8" • 1819mm</p> <p>VKBT30084078</p>
<p>ROD FRAME GLASS</p> <p>54 3/4" • 1391mm 54" • 1372mm 47 5/8" • 1210mm</p> <p>VKBT30084054</p>	<p>ROD FRAME GLASS</p> <p>70 3/4" • 1797mm 63 5/8" • 1616mm</p> <p>VKBT30084070</p>	<p>ROD FRAME GLASS</p> <p>78 3/4" • 2000mm 78" • 1981mm 71 5/8" • 1819mm</p> <p>VKBT30084078</p>
<p>ROD FRAME GLASS</p> <p>56 3/4" • 1432mm 56" • 1413mm 51 5/8" • 1311mm</p> <p>VKBT30084058</p>	<p>ROD FRAME GLASS</p> <p>70 3/4" • 1797mm 63 5/8" • 1616mm</p> <p>VKBT30084070</p>	<p>ROD FRAME GLASS</p> <p>78 3/4" • 2000mm 78" • 1981mm 71 5/8" • 1819mm</p> <p>VKBT30084078</p>

Frame: 19"- 46"- 19"
 Cadre: 483mm-1168mm-483mm
 Visible glass: 12 5/8"- 39 5/8"- 12 5/8"
 Verre visible: 321mm-1006mm-321mm

92" Units (30° Bay)

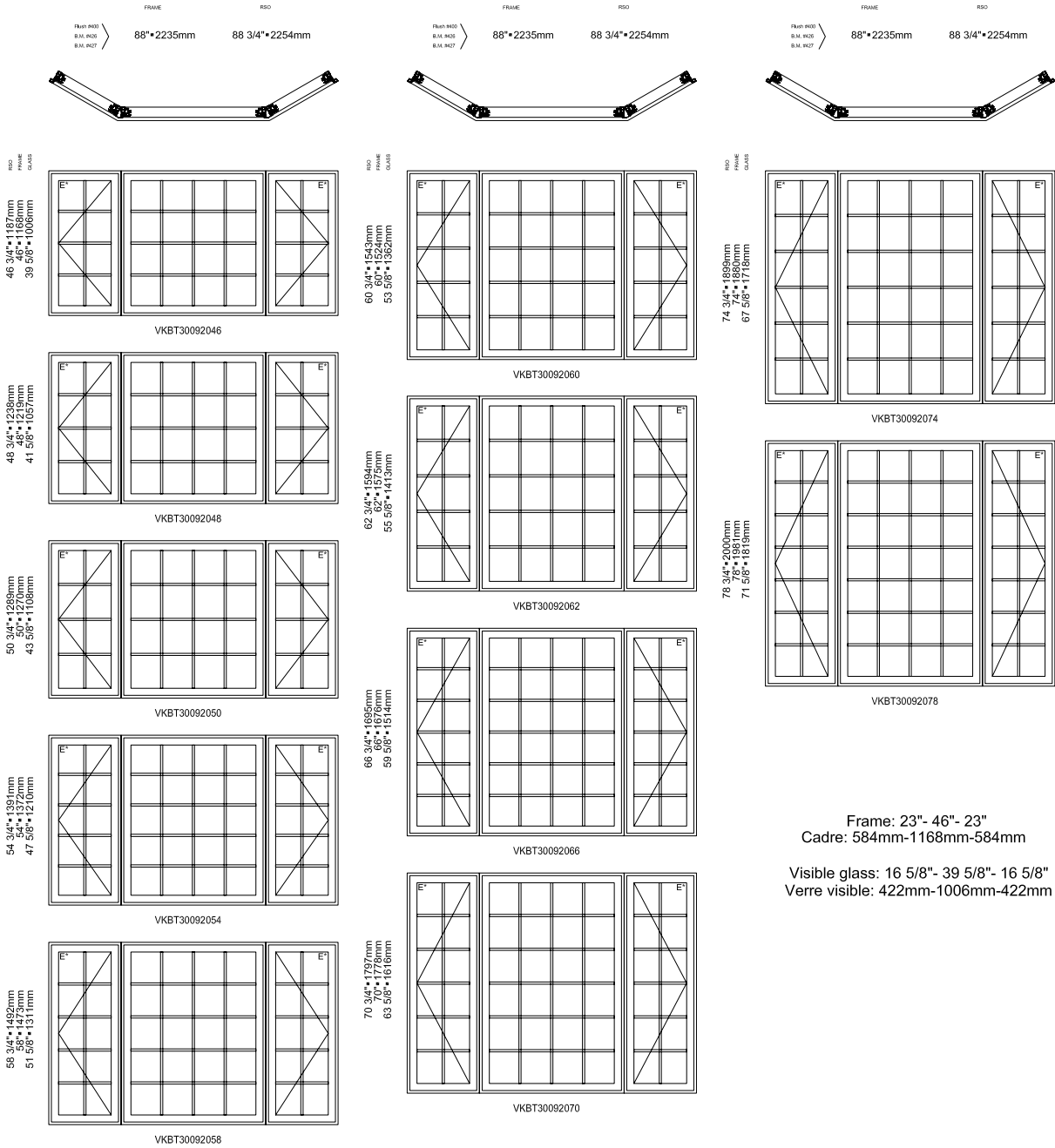

100" Units (30° Bay)

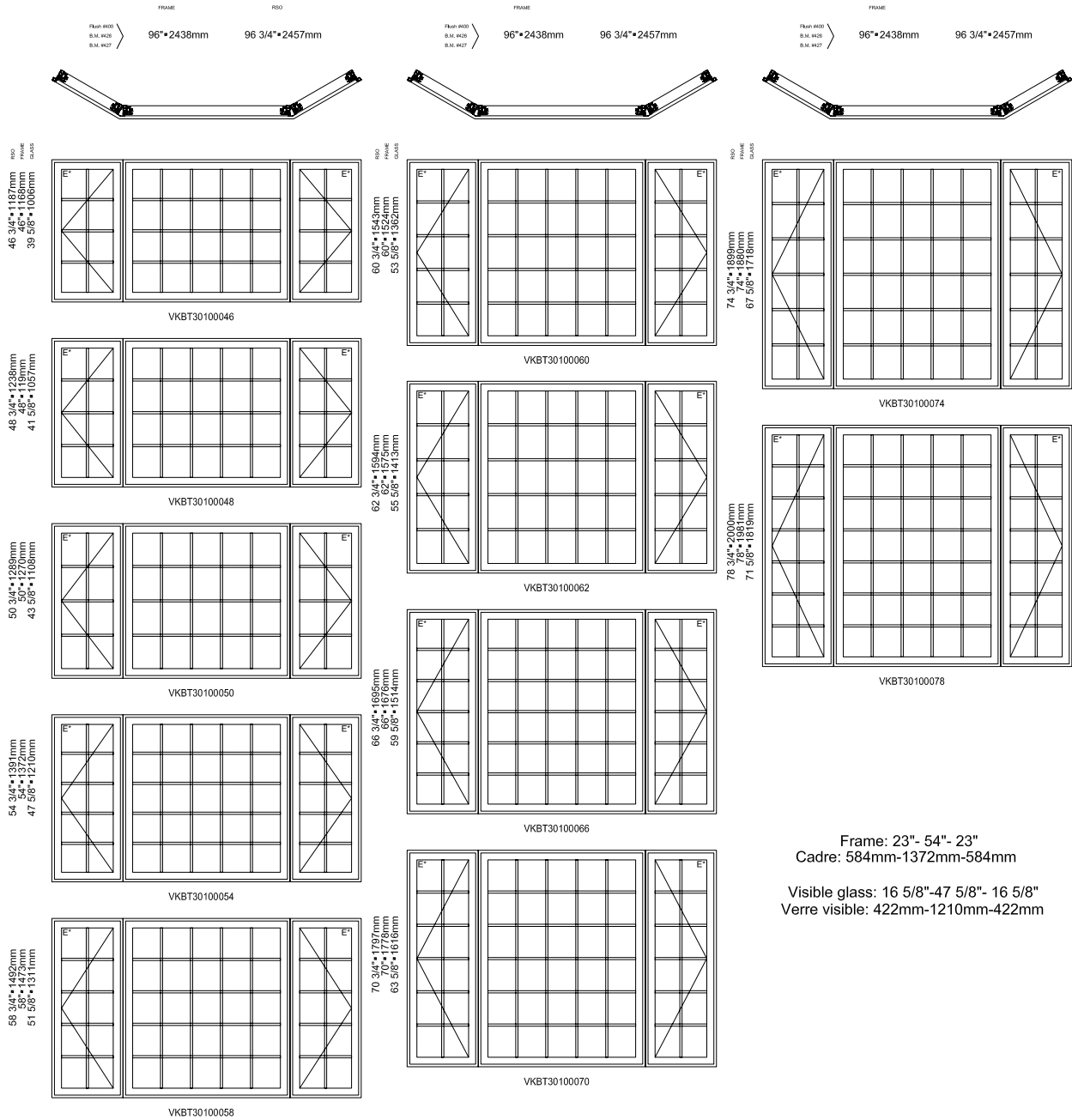

108" Units (30° Bay)

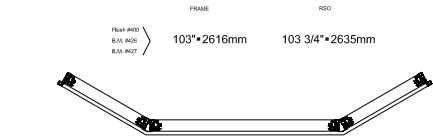

Frame: 27" - 54" - 27"
 Cadre: 686mm-1372mm-686mm

Visible glass: 20 5/8" - 47 5/8" - 20 5/8"
 Verre visible: 524mm-1210mm-524mm

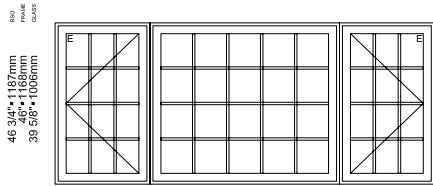
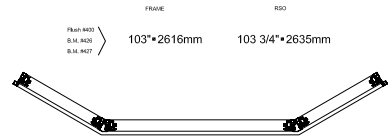

VKBT30108046

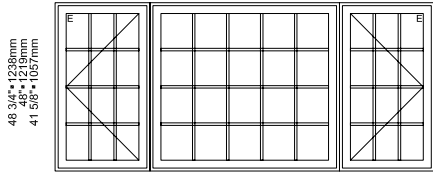

VKBT30108048

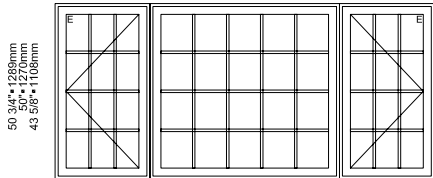

VKBT30108050

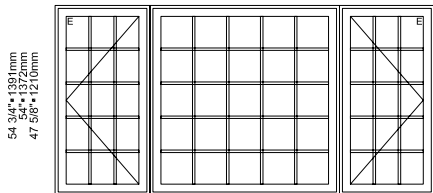

VKBT30108054

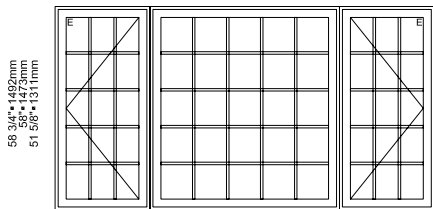

VKBT30108058

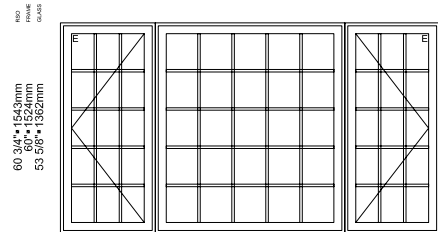

VKBT30108060

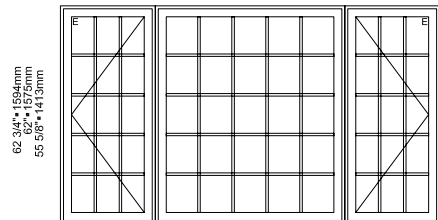

VKBT30108062

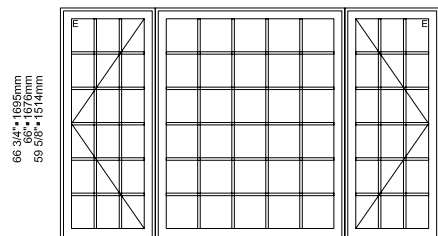

VKBT30108066

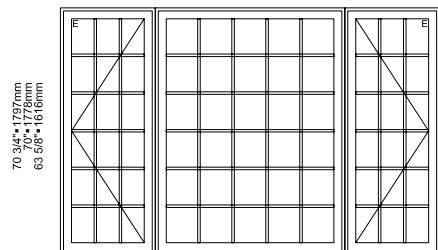

VKBT30108070

108" Units (30° Bay) cont'd

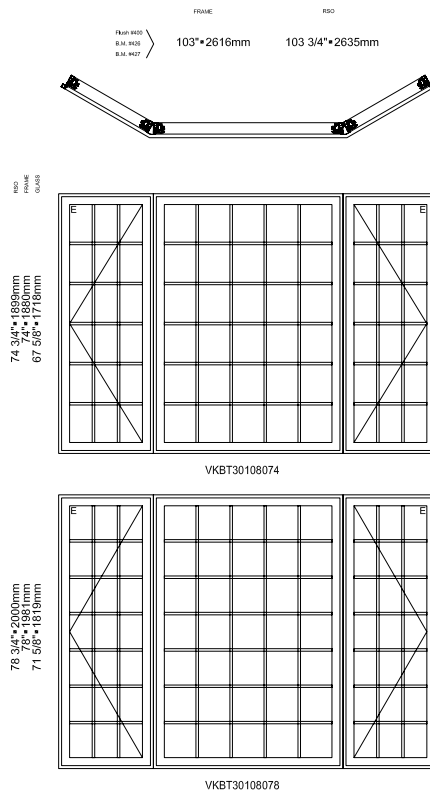

Frame: 27"- 54"- 27"
 Cadre: 686mm-1372mm-686mm

Visible glass: 20 5/8"- 47 5/8"- 20 5/8"
 Verre visible: 524mm-1210mm-524mm

116" Units (30° Bay)

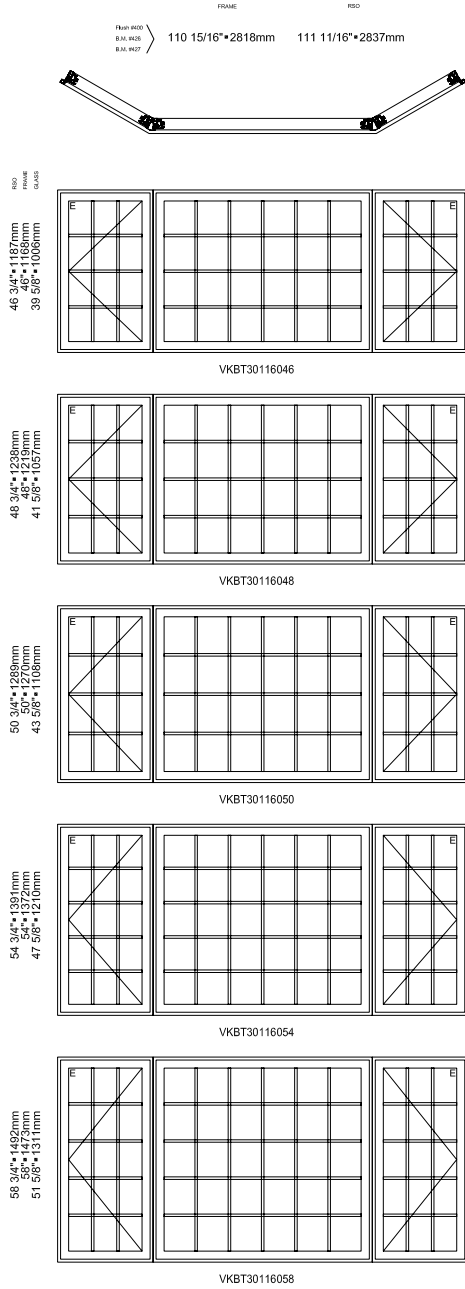

Frame: 27"- 62"- 27"
 Cadre: 686mm-1575mm-686mm
 Visible glass: 20 5/8"- 55 5/8"- 20 5/8"
 Verre visible: 524mm-1413mm-524mm

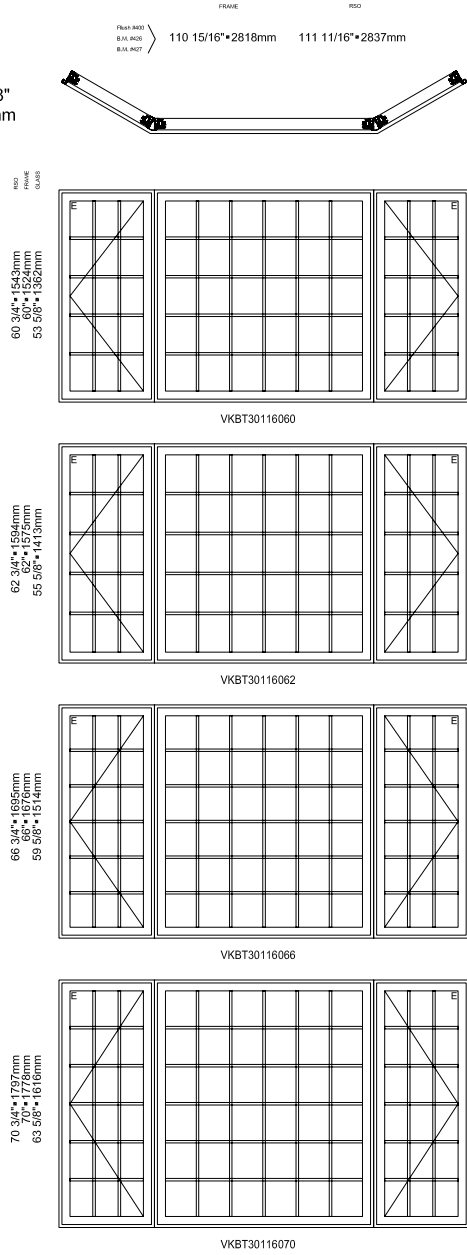

116" Units (30° Bay) cont'd

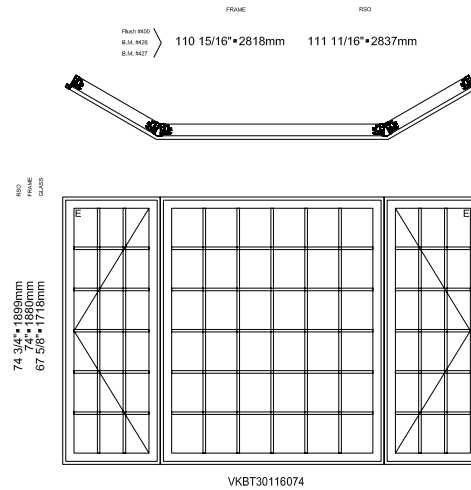

Frame: 27"- 62"- 27"
 Cadre: 686mm-1575mm-686mm

Visible glass: 20 5/8"- 55 5/8"- 20 5/8"
 Verre visible: 524mm-1413mm-524mm

76" Units (45° Bay)

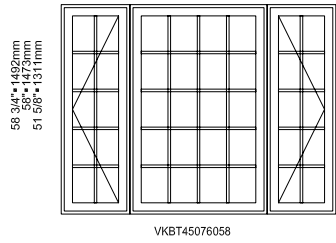
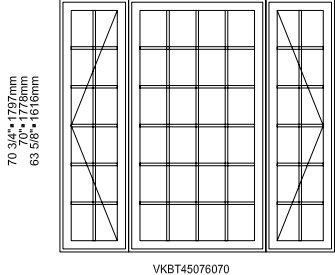
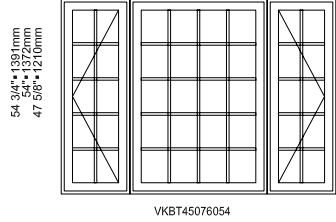
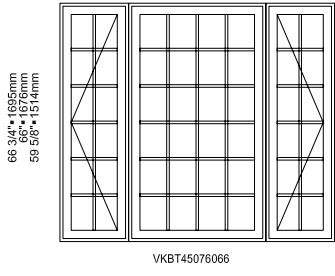
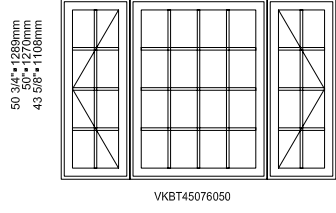
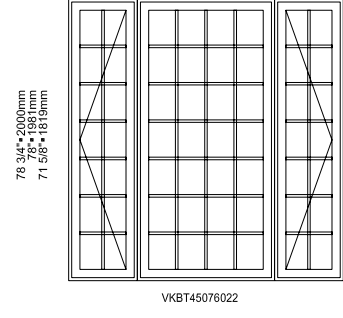
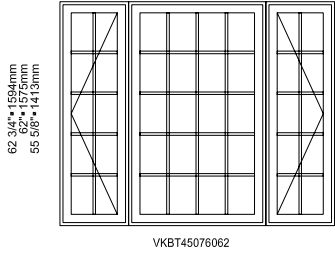
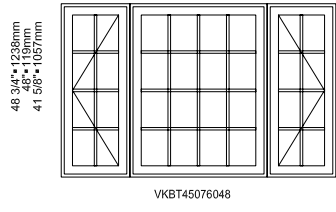
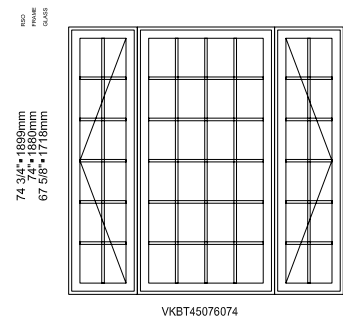
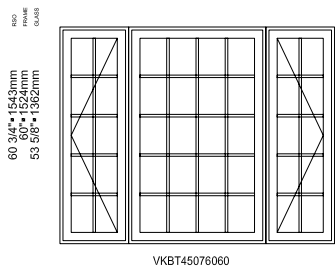
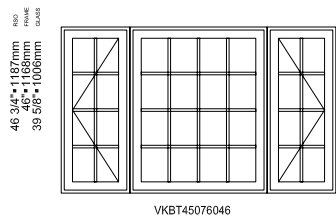
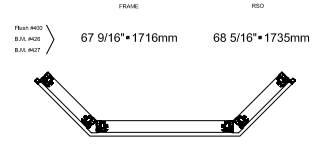
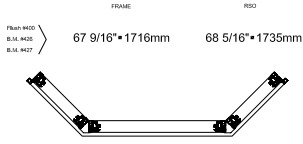
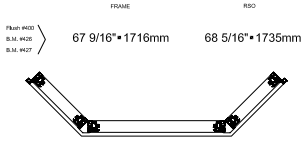

Frame: 19" - 38" - 19"
 Cadre: 483mm-965mm-483mm
 Visible glass: 12 5/8" - 31 5/8" - 12 5/8"
 Verre visible: 321mm-803mm-321mm

84" Units (45° Bay)

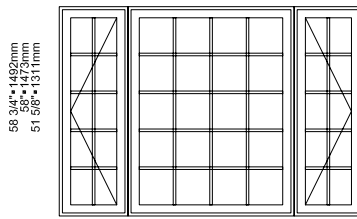
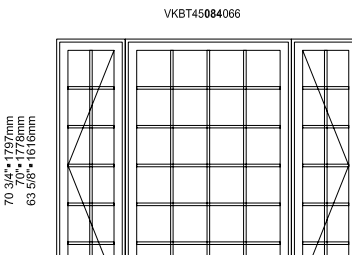
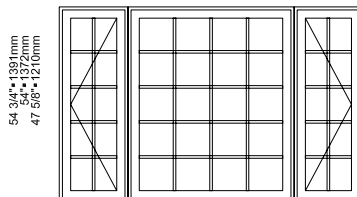
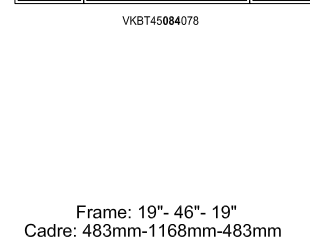
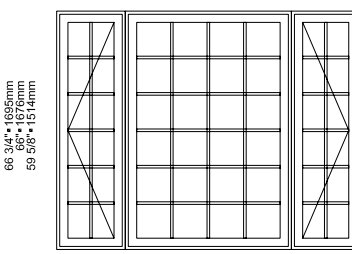
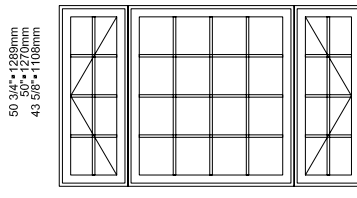
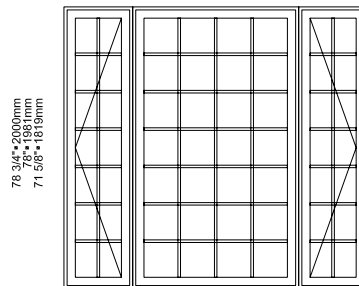
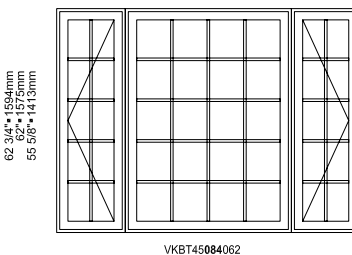
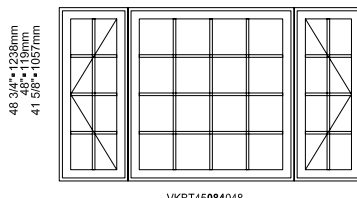
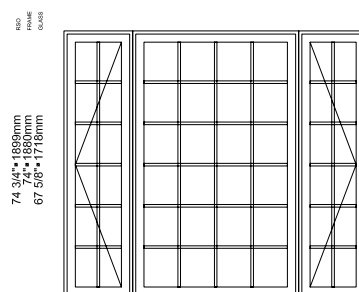
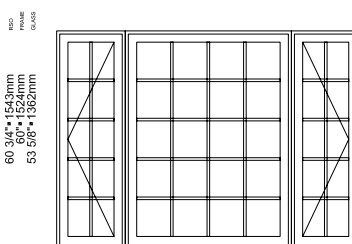
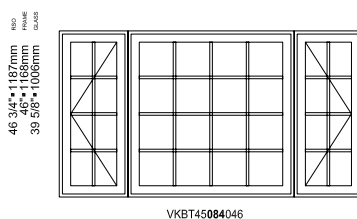
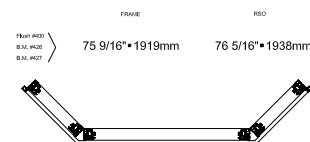
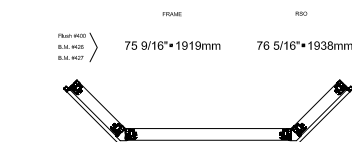
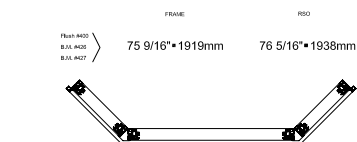

Frame: 19"- 46"- 19"
 Cadre: 483mm-1168mm-483mm
 Visible glass: 12 5/8"- 39 5/8"- 12 5/8"
 Verre visible: 321mm-1006mm-321mm

92" Units (45° Bay)

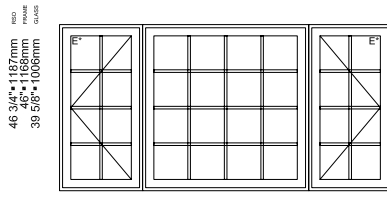
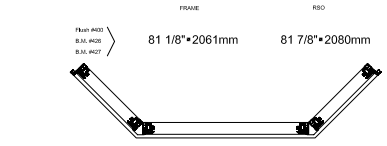

VKBT45092046

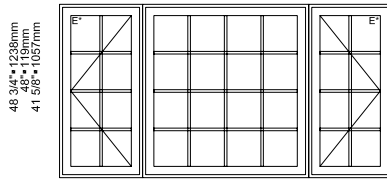

VKBT45092048

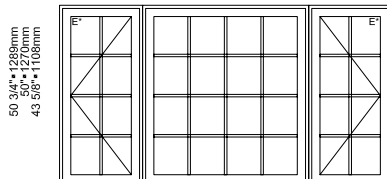

VKBT45092050

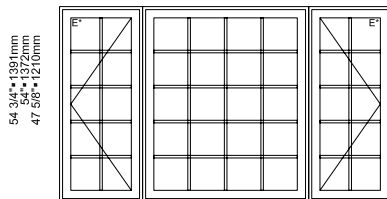

VKBT45092054

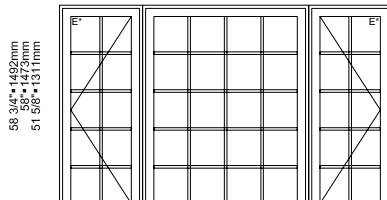

VKBT45092058

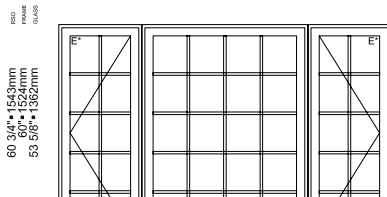
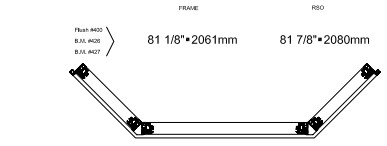

VKBT45092060

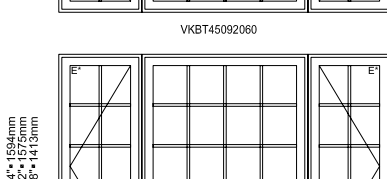

VKBT45092062

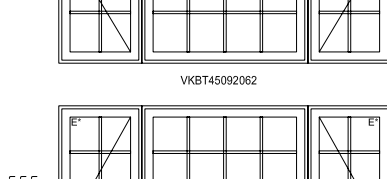

VKBT45092066

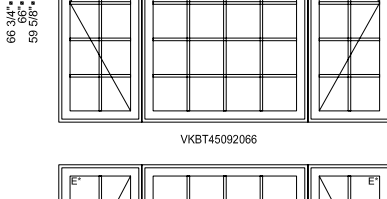

VKBT45092070

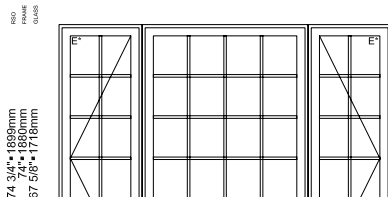
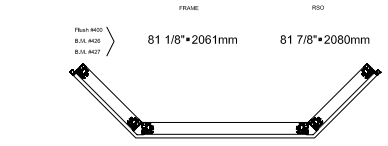

VKBT45092074

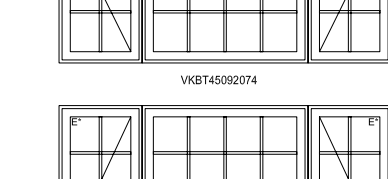

VKBT45092078

Frame: 23"- 46"- 23"
 Cadre: 584mm-1168mm-584mm
 Visible glass: 16 5/8"- 39 5/8"- 16 5/8"
 Verre visible: 422mm-1006mm-422mm

100" Units (45° Bay)

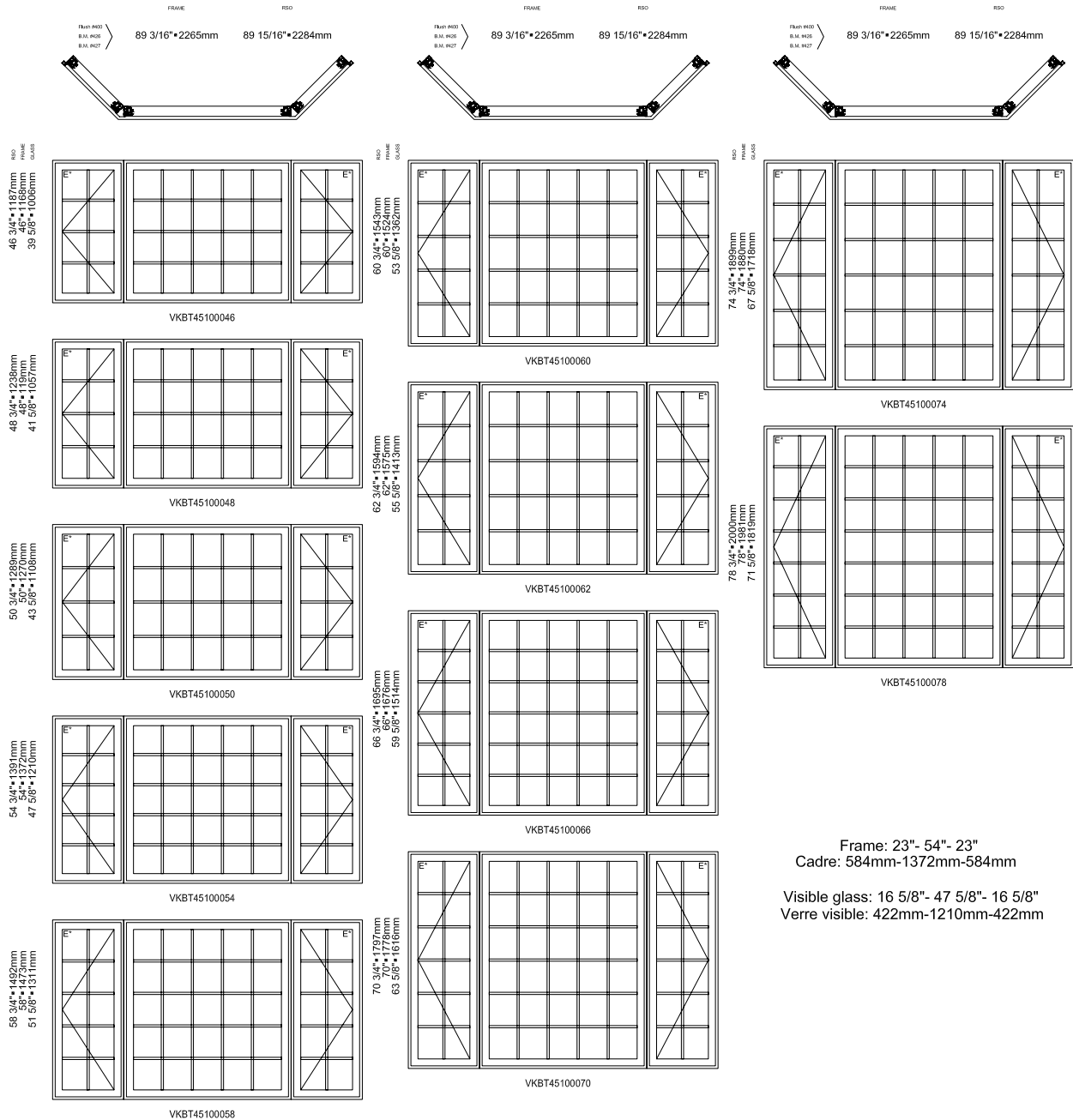

108" Units (45° Bay)

FRAME RSO
 94 7/8" • 2410mm 95 5/8" • 2429mm

Visible glass: 20 5/8" - 47 5/8" - 20 5/8"
 Verre visible: 524mm - 1210mm - 524mm

46 3/4" • 1187mm
 46 3/4" • 1187mm
 39 5/8" • 1006mm

VKBT45108046

48 3/4" • 1238mm
 48 3/4" • 1238mm
 41 5/8" • 1057mm

VKBT45108048

50 3/4" • 1289mm
 50 3/4" • 1289mm
 43 5/8" • 1108mm

VKBT45108050

54 3/4" • 1391mm
 54 3/4" • 1391mm
 47 5/8" • 1210mm

VKBT45108054

58 3/4" • 1493mm
 58 3/4" • 1493mm
 51 5/8" • 1311mm

VKBT45108058

Frame: 27"- 54"- 27"
 Cadre: 686mm-1372mm-686mm

Visible glass: 20 5/8"- 47 5/8"- 20 5/8"
 Verre visible: 524mm-1210mm-524mm

FRAME RSO
 94 7/8" • 2410mm 95 5/8" • 2429mm

60 3/4" • 1529mm
 60 3/4" • 1529mm
 53 5/8" • 1362mm

VKBT45108060

62 3/4" • 1580mm
 62 3/4" • 1580mm
 55 5/8" • 1413mm

VKBT45108062

66 3/4" • 1682mm
 66 3/4" • 1682mm
 59 5/8" • 1514mm

VKBT45108066

70 3/4" • 1784mm
 70 3/4" • 1784mm
 63 5/8" • 1616mm

VKBT45108070

108" Units (45° Bay) cont'd

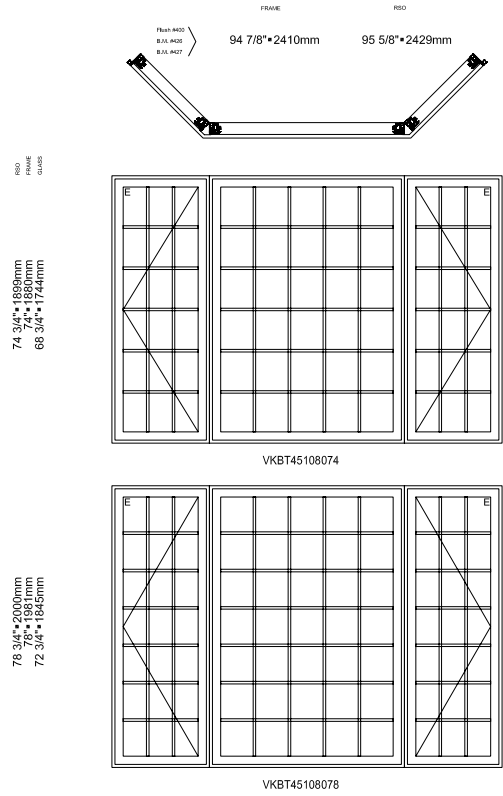

Frame: 27"- 54"- 27"
 Cadre: 686mm-1372mm-686mm
 Visible glass: 20 5/8"- 47 5/8"- 20 5/8"
 Verre visible: 524mm-1210mm-524mm

116" Units (45° Bay)

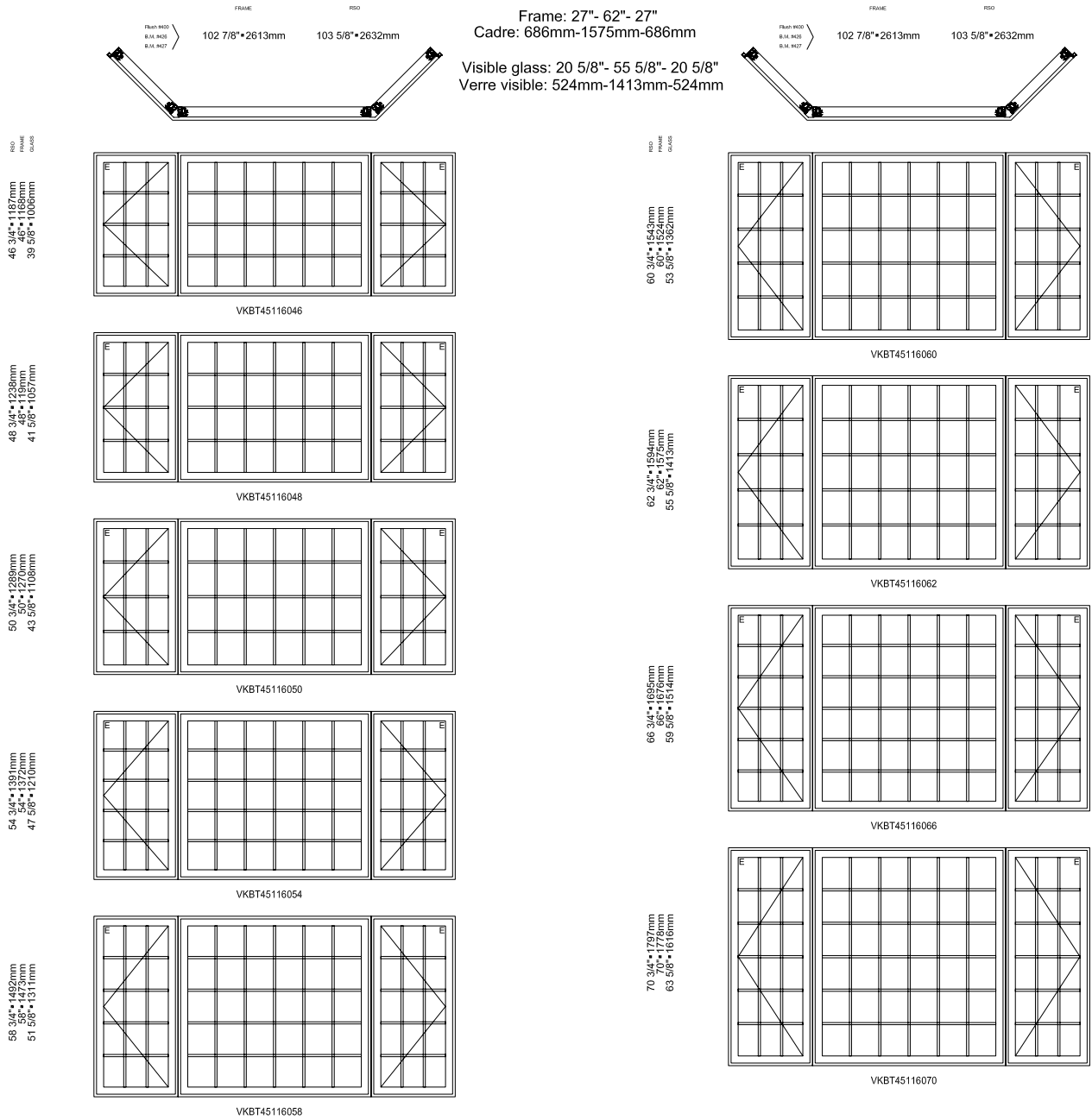

116" Units (45° Bay) cont'd

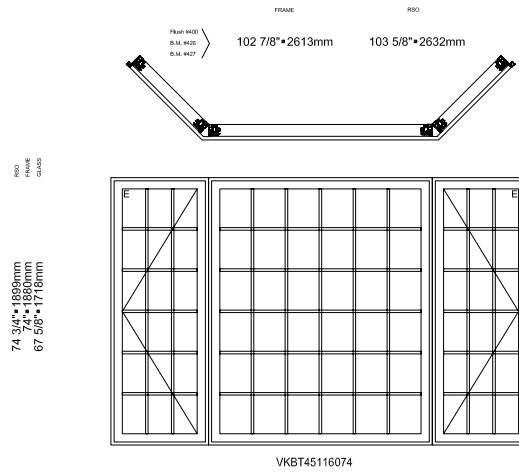

Frame: 27"- 62"- 27"
 Cadre: 686mm-1575mm-686mm

Visible glass: 20 5/8"- 55 5/8"- 20 5/8"
 Verre visible: 524mm-1413mm-524mm

GLAZING OPTIONS - INTERNAL GRILLES - TRIPANE

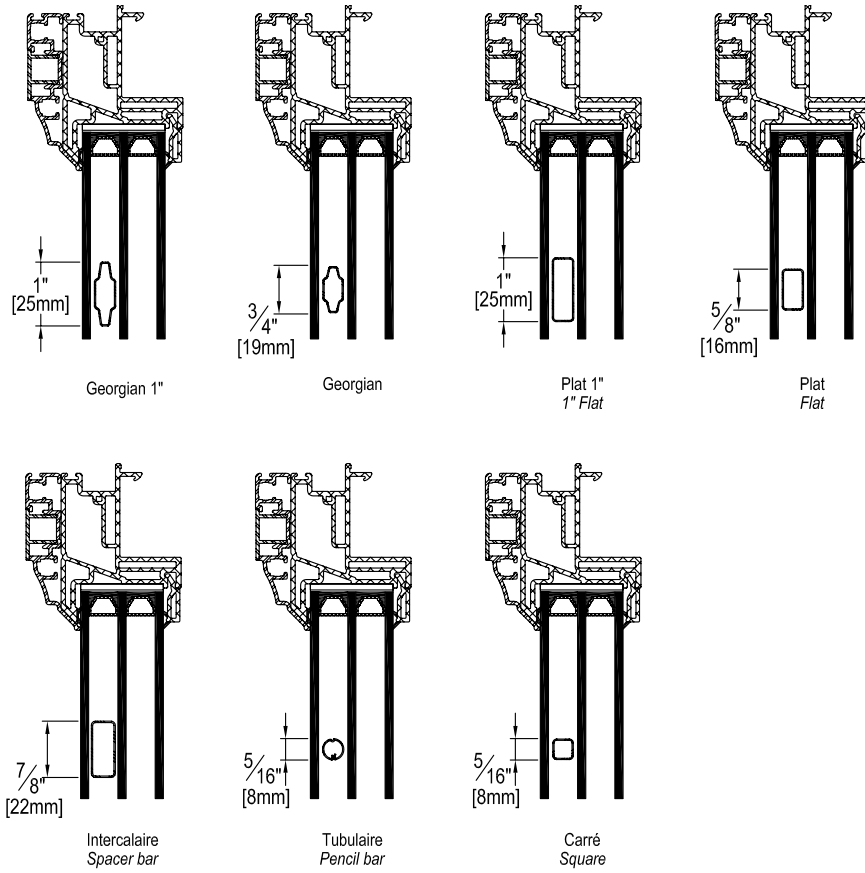

GLAZING OPTIONS - INTERNAL GRILLES - DUALPANE

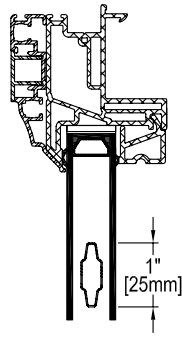

Georgian 1"

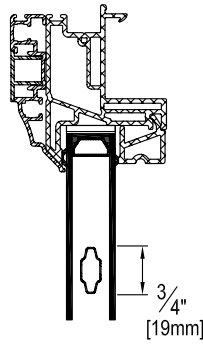

Georgian

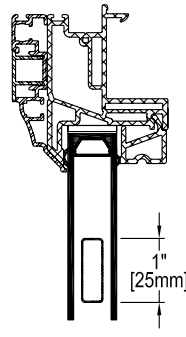

Plat 1"
1" Flat

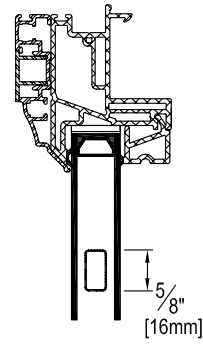

Plat
Flat

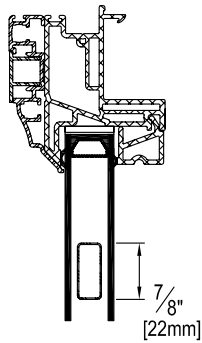

Intercalaire
Spacer bar

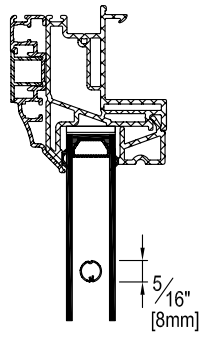

Tubulaire
Pencil bar

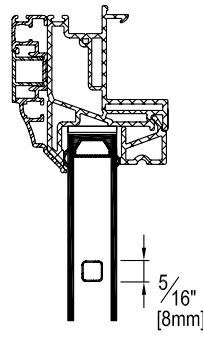

Carré
Square

GLAZING OPTIONS - SIMULATED DIVIDED LITES & FALSE MULLIONS - TRIPANE

Simili barrotin avec intercalaire
Simulated divided lite with spacer-bar

Simili barrotin
Simulated divided lite

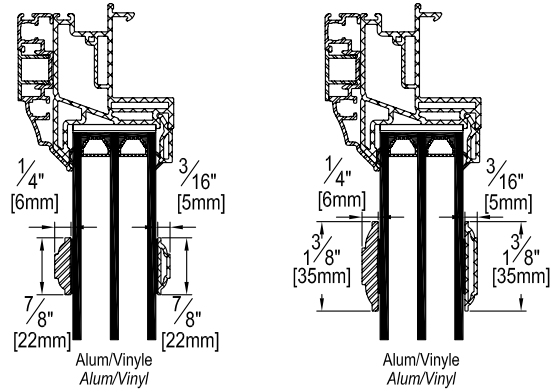
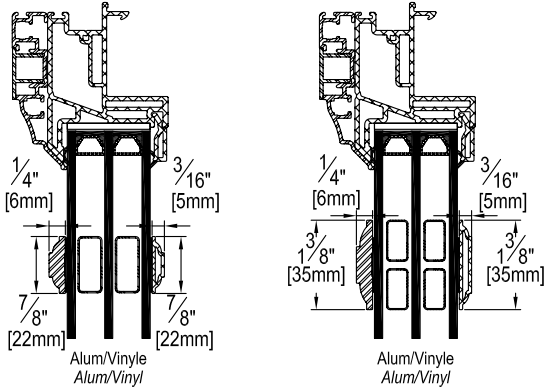

Faux-meneau avec intercalaire
False mullion with spacer-bar

Faux-meneau
False mullion

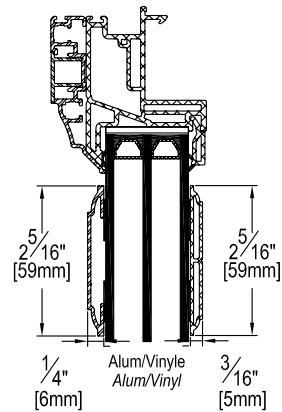
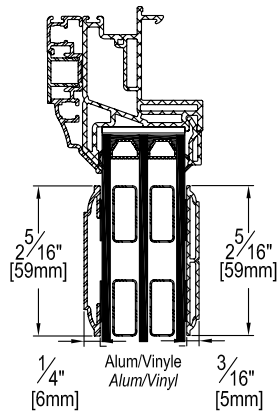

GLAZING OPTIONS - SIMULATED DIVIDED LITES & FALSE MULLIONS - DUALPANE

Simili barrotin avec intercalaire
Simulated divided lite with spacer-bar

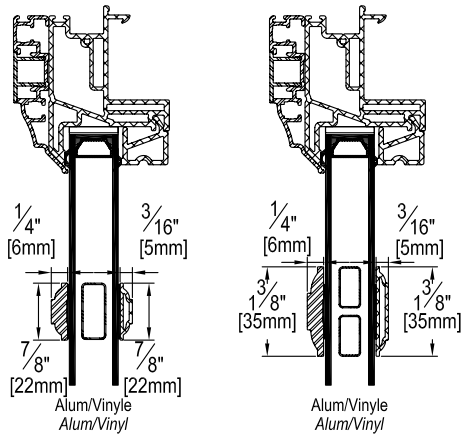

Simili barrotin
Simulated divided lite

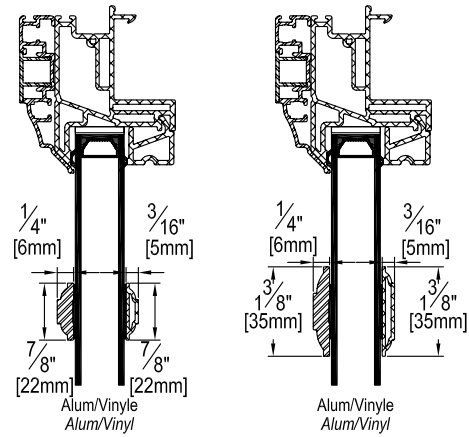

Faux-meneau avec intercalaire
False mullion with spacer-bar

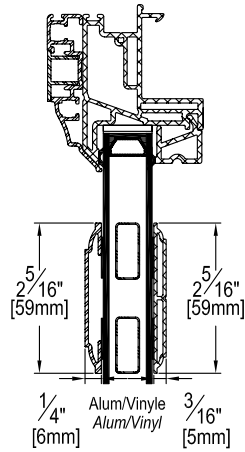

Faux-meneau
False mullion

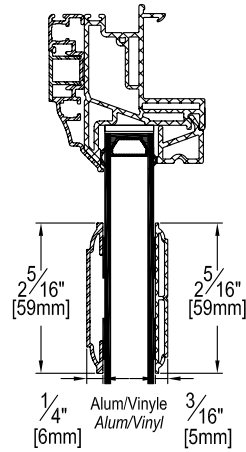

JAMB EXTENSION OPTIONS - ALUMINUM

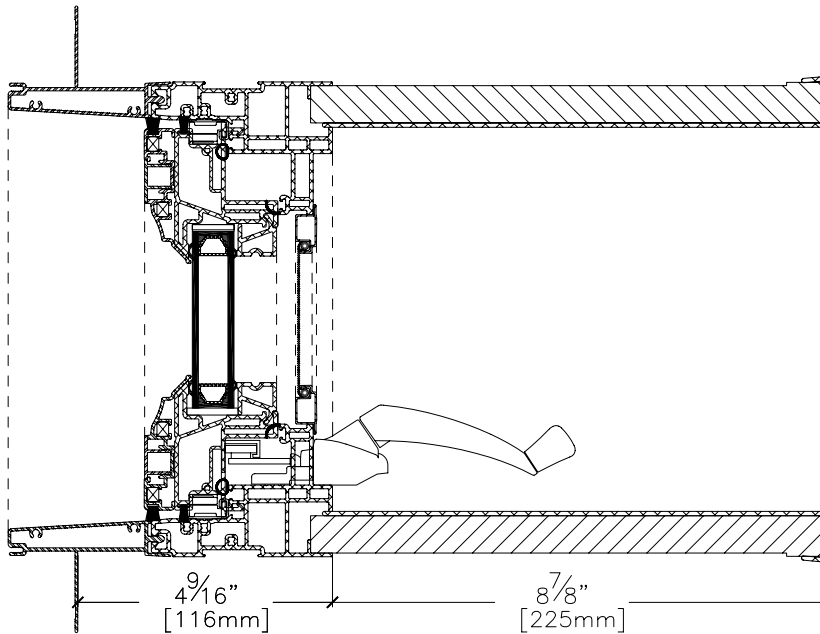
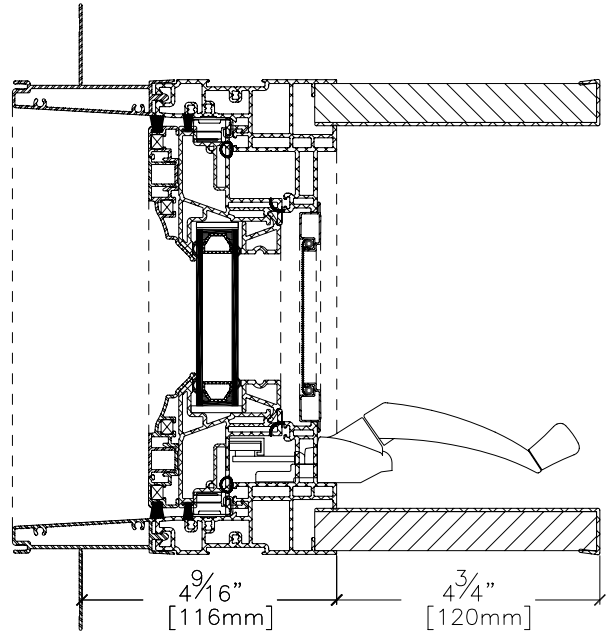
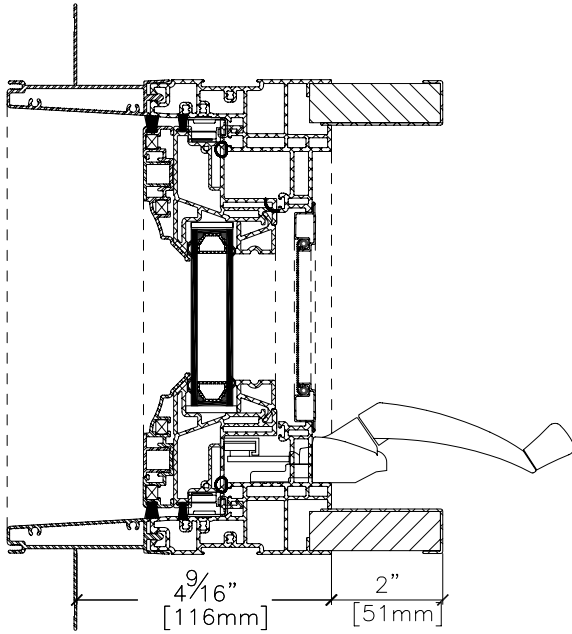

JAMB EXTENSION OPTIONS - WOOD

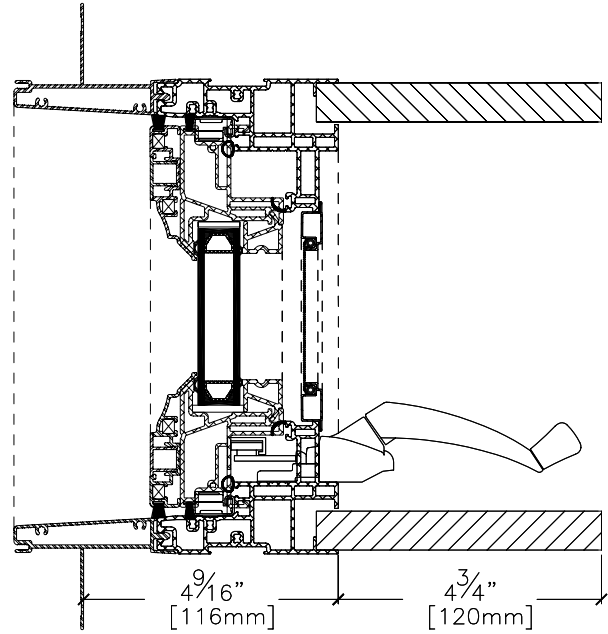
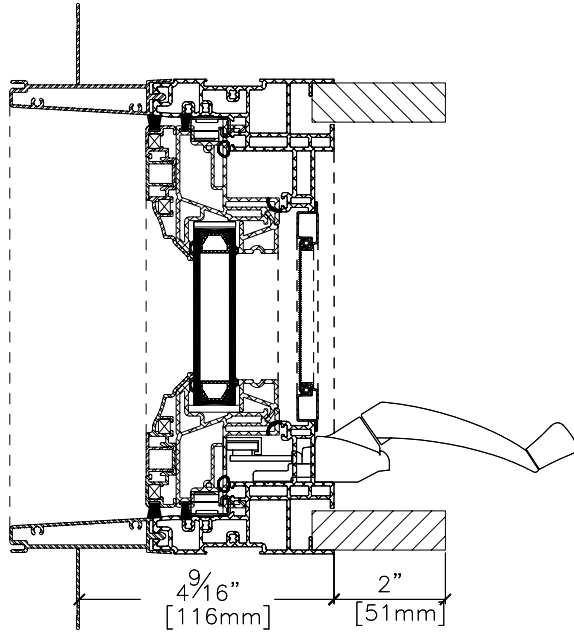

MULLION DETAILS

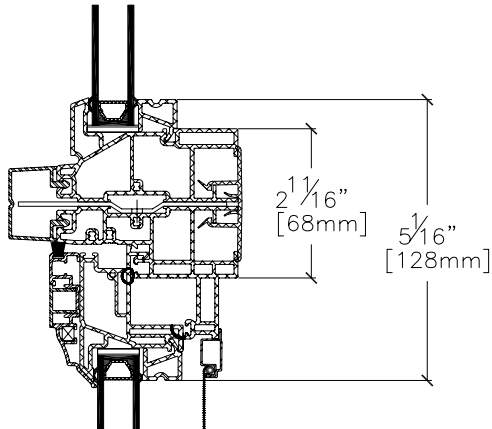

Imposte verre scellé fixe
Cadre de vinyle
Transom with fixed lite
Vinyl frame

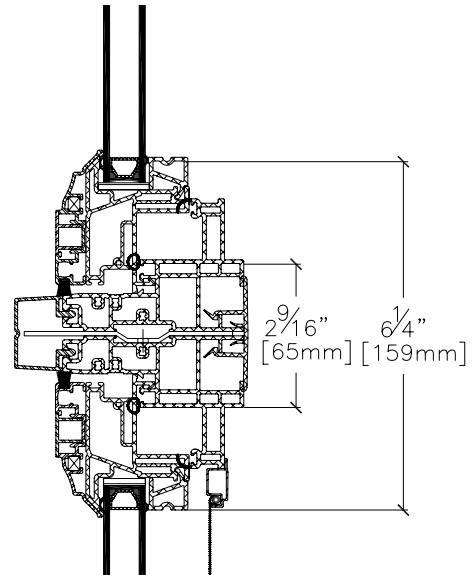

Imposte volet fixe
Cadre de vinyle
Transom with fixed sash
Vinyl frame

TRIM OPTIONS - FLUSH FRAME WITH AND WITHOUT FLANGE

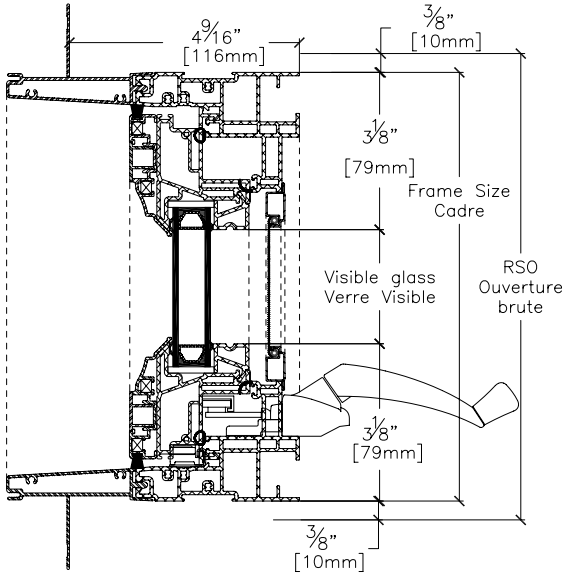

4 9/16" flush avec lame
 4 9/16" flush frame with flange

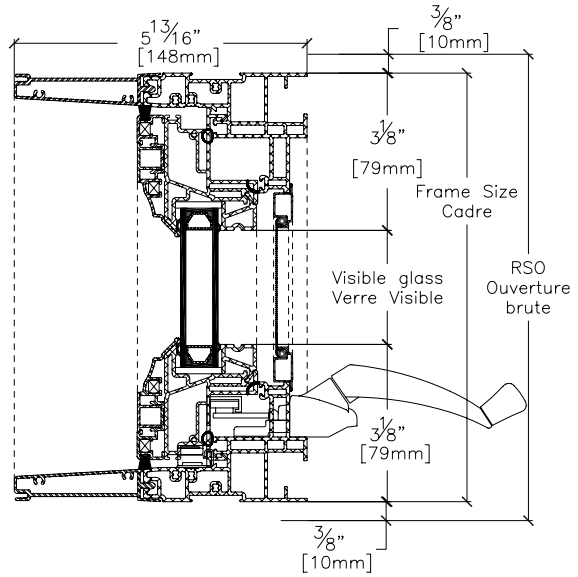

4 9/16" flush sans lame
 4 9/16" flush frame without flange

TRIM OPTIONS - 1 1/2" BRICKMOULD WITH AND WITHOUT FLANGE

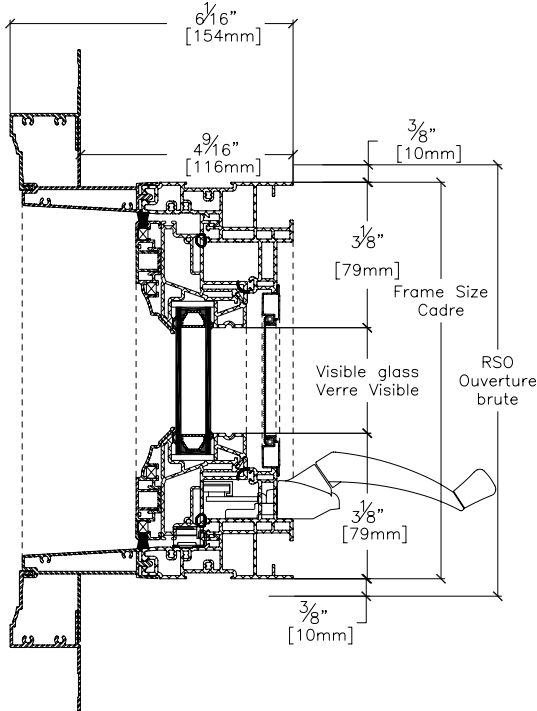

4 9/16" moulure 1 1/2" avec lame
 4 9/16" 1 1/2" brickmould with flange

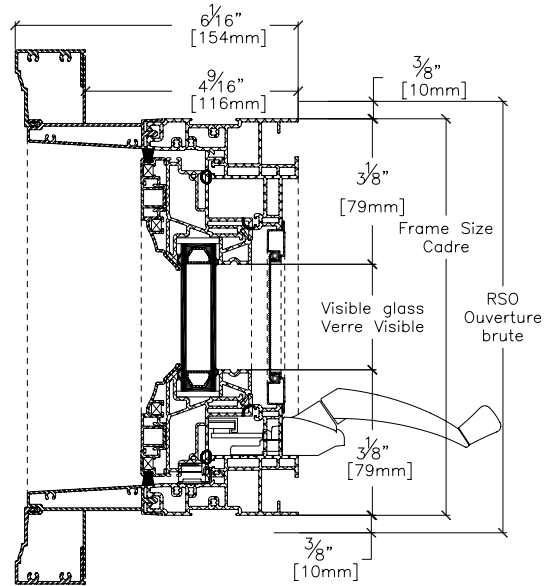

4 9/16" moulure 1 1/2" sans lame
 4 9/16" 1 1/2" brickmould without flange

TRIM OPTIONS - 3 1/2" BRICKMOULD WITH AND WITHOUT FLANGE

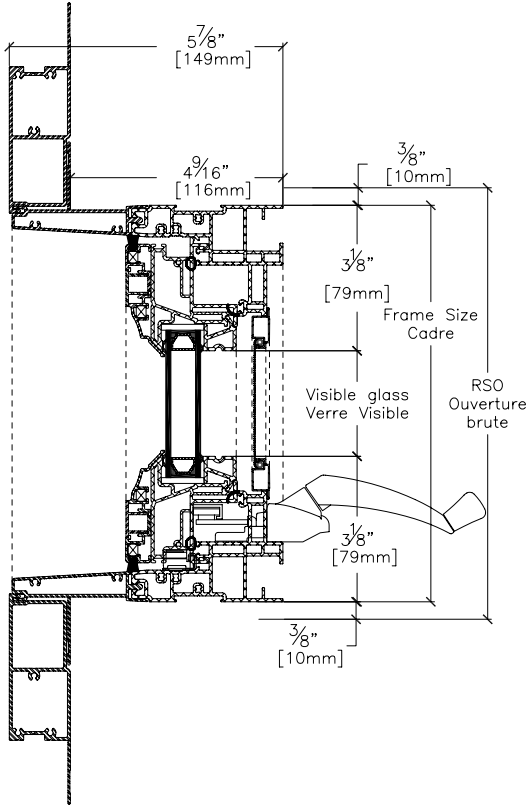

4 9/16" moulure 3 1/2" avec lame
 4 9/16" 3 1/2" brickmould with flange

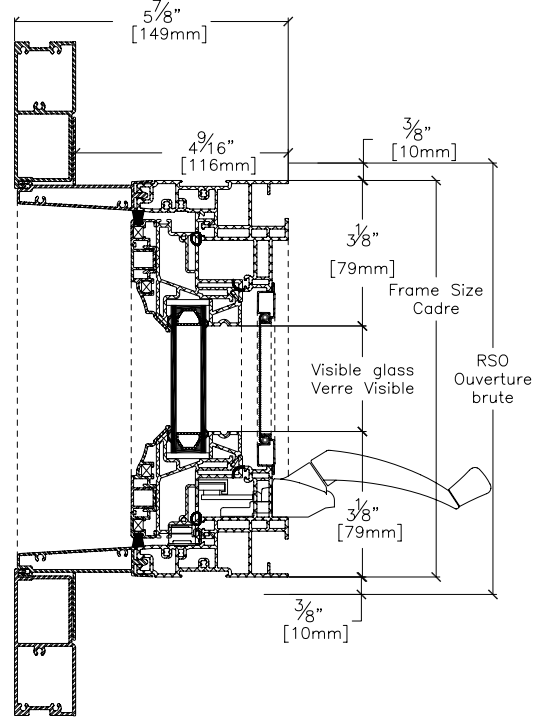

4 9/16" moulure 3 1/2" sans lame
 4 9/16" 3 1/2" brickmould without flange

90° CORNER MULLION

