

The following maximum mullion rules apply to product manufactured from the Willmar plant and are for residential housing only. Contact your Territory Sales Manager or Customer Service Representative if you require further clarification.

**Willmar Collection Vinyl Windows - Mullion Rules**

The horizontal mullion (stud to stud) and vertical mullion (bottom plate to header) can not exceed 2400mm (94 1/2") in both directions. As long as one mullion does not exceed 2400mm the opposite mullion can extend up to 3600mm (141 3/4"), but can not exceed the overall combination unit size of 96 sq. ft. 8'0" stud to stud required.

**Willmar Collection Vinyl Windows - Examples**

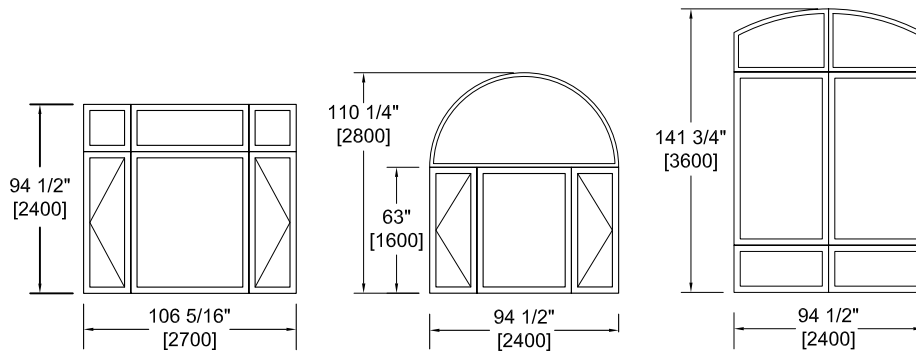

SCALE: 3" = 1'-0"

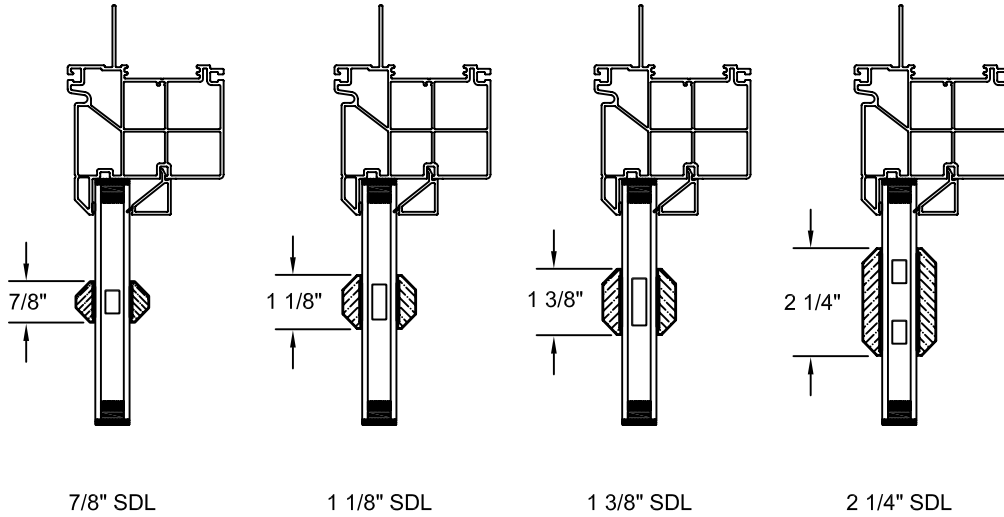

Simulated Divided Lites available in ES7000 Casement, Fixed, Awning, Picture and Specialty windows.

Shown with optional internal shadow bar.

SCALE: 3" = 1'-0"

**INTERNAL GRILLES**

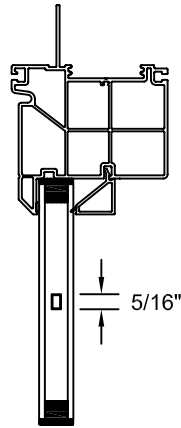

NARROW  
INTERNAL GRILLE

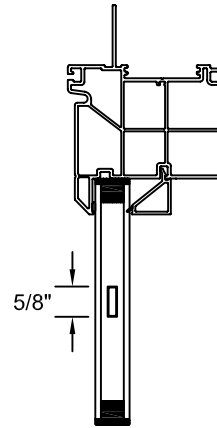

WIDE  
INTERNAL GRILLE

Internal Grilles available in all ES7000  
and ES3500 windows.

SCALE: 3" = 1'-0"

**RECTANGULAR**



7512  
(3X4)

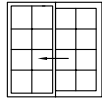

SL1212  
(4X4)



SH 612  
(2X4)

**PRAIRIE**



7512

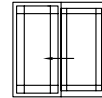

SL1212



SH 612

**TRANSOM 3-1**

11 13/16" [300]

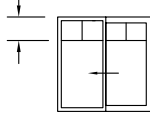

SL1212

11 13/16" [300]

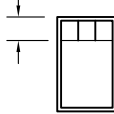

7512

**TRANSOM 4-1**

15 3/4" [400]

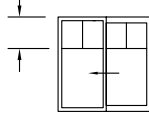

SL1212

15 3/4" [400]

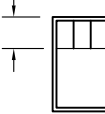

7512

**TRANSOM 3-2**

23 5/8" [600]

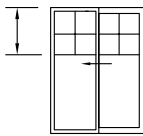

SL1216

23 5/8" [600]

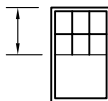

7512

**TRANSOM 4-2**

31 1/2" [800]

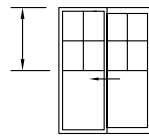

SL1216

31 1/2" [800]

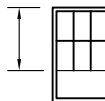

7512